



eclipse SM
Savings Without Sacrifice

Pro'sKit®

Professional Tool Solutions Since 1991

CATALOG 17

BUILDING ON OUR 20 YEAR PARTNERSHIP WITH PRO'SKIT, ECLIPSE TOOLS
CONTINUES TO PROUDLY OFFER THEIR BRAND OF EXCEPTIONAL QUALITY PRODUCTS

AC TRUE-RMS MULTIMETER

NEW

MT-1707 3 5/6 TRUE-RMS MULTIMETER

CAT IV 600V
 CAT III 1000V



30 Positions, Full Functions

Large LCD w/ backlight
Design with 3 5/6 digits 5999 counts large display.

Non contact voltage detector
Tests AC 90-1000V

Voltage level indicator
To show the voltage signal intensity.

Friendly extra functions
Continuity with beeper, duty cycle, data hold, auto power off, LED light, low battery indication and input alert protection.

Specifications	MT-1707
DCV	600mV/6V/60V/600V/1000V ±(0.5%+3d)
ACV TrueRMS	6V/60V ±(0.8%+3d) 600V/750V ±(1%+10d) Frequency Response : 40Hz-1KHz
DCA	60uA/6mA/60mA/600mA±(0.8%+3d) 10.00A±(1.2%+3d)
ACA TrueRMS	60mA/600mA±(1%+3d) 10.00A±(1.5%+3d) Frequency Response : 40Hz-1KHz
Frequency (Hz)	9.999Hz/99.99Hz/999.9Hz/9.999KHz/ 99.99KHz/999.9KHz/9.99MHz ±(1.0%+3d)
Resistance	600Ω/6kΩ/60kΩ/600kΩ/6MΩ±(0.8%+3d) 60MΩ±(1.2%+30d)
Capacitance	6nF±(4.0%+30d) 60nF/600nF/6μF/60uF/600uF/6mF±(4.0%+3d) 100mF ±(5.0%+3d)
Temperatures	-20°C~1000°C/-4°F~1832°F±(1.0%+3d)
Certificate	600V CAT IV/1000V CATIII
Fuse	FF600mA/1000V, FF10A/1000V
Power	4 x 1.5V AA Batteries (not included)
Weight	340g (without battery)
Size	192 × 89 × 55mm / 7.5" x 3.5" x 2.5"

Individual packing: Color box



ACV True-RMS

Live wire test



MT-1506 3 3/4 POCKET TRUE-RMS AUTO RANGE MULTIMETER

Specifications	MT-1506
DCV	400mV,4/40/400V ±(0.5%+4d), 600V ±(1%+4d)
ACV True-RMS	400mV±(1.5%+6d), 4/40/400V ±(0.8%+6d), 600V ±(1.0%+6d)
Resistance	400Ω ±(0.8%+5d) 4k/40k/400k/4MΩ ±(0.8%+4d), 40MΩ ±(1.2%+5d)
Frequency	100/1000Hz/10k/100k/1MHz/ 10MHz ±(0.5%+4d)
Capacitance	4nF ±(5%+40d), 40n/400n/4μ/40μ ±(3.5%+8d), 2000μF ±(5%+8d)
Duty cycle	0.1~99.9% ±(0.5%+4d)
Continuity with beeper	50 ±30Ω
Diode test	Range: 0 ~ 1.5V Resolution: 1mV
Power	2 x 1.5V AAA battery (Not included)
Size	124 × 80 × 20 mm / 5" x 3.1" x 0.8"

Individual packing: Color box

CAT II 600V

Auto 3 3/4 range provide accurate measurement

Pocket size
Design for easy carrying.

Built-in test lead

Extra function
continuity with beeper, Hz/Duty, auto power off, low battery indication.



MT-3112 3 5/6 SMART TRUE-RMS FLEX CLAMP METER

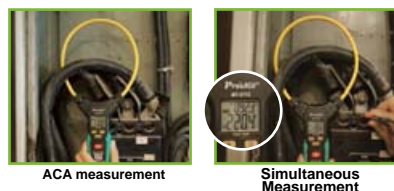

ACA measurement

Simultaneous Measurement

Specifications	MT-3112
ACA True-RMS	60A/600A/3000A±(2%+5d) (40Hz~65Hz) 60A/600A/3000A±(3%+5d) (65Hz~200Hz) ≤1000A±(3%+5d), >1000A (200Hz~1000Hz) for reference.
ACV True-RMS	6V /60V/600V ±(1.2%+3d) (45Hz~65Hz) 6V /60V/600V ±(2.0%+5d) (40Hz~45Hz, 65Hz~2000Hz)
DCV	6V/60V/600V ±(0.8%+3d)
Resistance	6K/60K/600K/6M ±(1.0%+3d)
Frequency	40~10kHz ±(0.5%+2d)
Power	1.5V AAA x 3 (Not included)
Size	324 x 178 x 30 mm / 12.7" x 7" x 1.2"

Individual packing: Color box

CAT IV 600V

3 5/6 Digital Smart Measurement

- Auto selection
- Auto range
- Super large frequency range: bandwidth:40-2000Hz

Simultaneous Measurement

Allows while measuring AC current simultaneously measured with AC/DC voltage and resistance.

Dual display with backlight

- Display the results of simultaneous measurement

Extra functions

Auto power off, low battery indication, data hold, LED light

7.5mm Flexible Clamp



MT-7063 PoE & LAN CABLE TESTER



2 IN 1

PoE Tester

- Easily tests ethernet network for power over ethernet existence
- Quickly detects the Endspan or Midspan

Cable Tester

- Check the RJ11/RJ12/RJ45 pin to pin cable map
- Automatically runs all tests and checks for continuity, open, short and crossover wire pairs
- Cable mapping up to 300M



Tests Midspan/Endspan



RJ11/RJ12/RJ45 Cable Test

Specifications	MT-7063
Max. distance of cable map	300m
Compatible connectors	RJ45(8 pin) & RJ11(6P/6C/4C/2C) & RJ12 & PoE
Cable types tested	RJ45 Lan cable Cat 5、5e、6(UTP/STP) RJ11/12 Telephone Cable Cat 3 (6P/2C/4C/6C)
Cable map indication	8 LED · Fast/Slow dual speed
Shielded indication	Yes
PoE indication(Master)	Midspan/Endspan
Live telecommunication equipment test and router test	Yes
Size	Master : 103×66×27mm / 4"x2.6"x1" Remote : 103×35×27mm / 4"x1.4"x1"
Power	DC 9.0V (not included)
Weight	130g (Not including battery)

Individual packing: Blister Card

902-558 HAND-HELD TDR



Accessories

Max. Test Distance: 3 Km

Specifications	902-558
Range	3km (9,842 ft.) max., 5 m (16.5 ft.) min.
Accuracy	±1.0% of reading
Resolution	1 cm (.40 in.)
V.O.P. (Velocity of propagation)	1.0% - 99.9% (In 0.1% step)
Auto V.O.P. set	Supported
User settable V.O.P.	8 memories
Auto power off	Supported
Display	128 X 64 Character LCD
Power supply	2 AA Batteries (not included)
Operation time	30,000 times with backlight
Safety (EMC)	EN 55011:2009/A1:2012/EN 61326-1:2013/EN 61326-2-2:2013
Dimensions	63 x 140 x 30 mm (2.5" x 5.5" x 1.2")
Accessories	Soft carrying case, test lead

Individual packing: Color box

MT-4606 INFRARED THERMOMETER



Air conditioning



CPU



Measuring power supply temperature



Ice chest

Specifications	MT-4606
Temperature Range	-50°C~380°C(-58°F~716°F)
Accuracy	≥ 100°C ±2%, ≤ 100°C ±2°C
Distance spot ratio	12 : 1
Emissivity	0.1~1.0
Laser class	Class II , <1mW
Response time & wavelength	500ms / 8-14µm
Repeatability	±2°C or ±2%
Unit selection	°C/°F
Backlight	Yes
Auto power off	Yes
Low battery indication	Yes
Data hold	Yes
Max. record	Yes
Storage temperature	-20 to 50°C(-4 to 122°F)
Operation temperature	0 to 50°C(32 to 122°F)
Operation humidity	10~95%RH
Power	9V Battery (not included)
Size	152x87x40mm / 6"x3.4"x1.57"
Weight	118g (not including battery)

Individual packing: Blister card

-50 to 380°C Measuring Range,
Resolution 0.1°F/°C

Distance Spot Ratio
12:1, 500ms Fast Response

Non-contact measurement
Non contact measurement in 2% best accuracy

Adjustable emissivity
From 0.10 ~ 1.00 emissivity adjustable for accurately measuring different surface types

User friendly design
Unit selection, backlight, auto power off, low battery indication, data hold, max. value



MT-4617LED LED LIGHT INTENSITY METER



Measures all visible light and LED white, red, yellow, green, blue, purple colors,
up to **200000 Lux / 20000 FC**

Specifications	MT-4617LED
Range	20、200、2000、20000、200000 Lux 20、200、2000、20000 FC
Ring spectral range	320~730nm
Accuracy	±3% (calibrated to standard incandescent lamp and LED at 2,854K) ±6% (calibrated at other visible light source)
Applications	For all visible light and LED white, red, yellow, green, blue, purple color
Unit selection	Lux,FC (Footcandles)
Sensor	Silicon photodiode
Sampling time	≥2 times/sec.
Auto power off	10 min after no use
Operation sound	Selection
Low battery indication	<7V
Operation environment	0~85%RH、-10~50°C(no condense)
Storage environment	0~70%RH、-10~50°C(no condense)
Operating altitude	Max. 2000m
Power	9V (not included)
Weight	154 g (not including battery)
Dimension	170x85x45mm / 6.7"x3.3"x1.8"
Accessory	Storage bag, instruction manual

Individual packing: Blister card

Measures all visible light and LED white, red, yellow, green, blue, purple colors, up to
200000 Lux / 20000 FC

Wide range of applications

High quality measurement
Built-in high precision photo diode sensor and color correction filter for indoor use

Both digital and analog
bargraph display

Auto and manual range

Relative and peak value
measurement

User friendly functions

Max./Min. value display, low battery indication、LUX/FC unit, auto power off、backlight、data hold, zero calibration



8PK-ST1520 DIGITAL EARTH RESISTANCE TESTER



3 1/2 digit 1999 counts

- Capable of measuring earth voltage.
- 2mA measuring current permits earth resistance tests without tripping earth leakage current breakers in the circuit under test.
- Extra function: data hold, auto power off, low battery, over range Indication.
- Safety standard: IEC-1010(EN61010), installation Category III.

Specifications	8PK-ST1520
Measurement	Earth Resistance by constant
System	Inverter. 820Hz, 2mA approx.
Earth voltage	0~200V AC, 40~500Hz.
Earth resistance range	0~200Ω(0.01Ω); 0~200Ω(0.4Ω), 0~2000Ω(1.0Ω)
Accuracy	Earth voltage ±(1%+2d); Earth resistance ±(2%+2d) or ± 0.1Ω, which is greater
Power	AA(1.5V)x6. (Not Included)
Size	163x100x50mm / 6.4"x3.9"x1.97"

Individual packing: Color box

8PK-ST850 PHASE SEQUENCE INDICATOR



Ideal for installing conveyor lines,

pump systems and interconnected drivers.

- Two functions in one unit including open phase and phase sequence.
- Large size alligator clips : able to clip on switch-board terminals easily.
- Identify 3 phase sequence and open phase check.
- No exposed metal parts. Safety features are incorporated throughout, including the pushbutton switch designed to minimize damage due to negligence.
- Safety approval: CE marks, IEN 1010 CAT II.

Specifications	8PK-ST850
Voltage ranges	90V~600V AC
Frequency response	50 / 60Hz.
Size	134x85x45mm / 5.28"x3.4"x1.8"
Cord	1.1m each of Red(R) White(S) and Black(T) cord

Individual packing: Color box

NT-309 SMART NON-CONTACT VOLTAGE TESTER



Detects AC 12 to 1000 V

Voltage level indication, red LED and audible alarm if voltage is present.

LED illumination

Voltage level indicator

Shows signal intensity.

Red LED & audible alarm

Detects AC voltage from 12 to 1000 VAC without metallic contact.

Signal intensity introduction



Neutral wire Close to Hot wire Hot wire

Specifications	NT-309
Test voltage range	12V~1000VAC, 50/60Hz
Auto power off	3 minutes
Low battery indication	Yes
Alarm system	Flashing LED with beeper alarm
LED light indicator	Yes
Power	2 x 1.5V AAA (not included)
Size	156x23x26mm / 6.1"x0.9"x1"
Weight	33g(Not included battery)

Individual packing: Blister Card

TE-8202A-W FIBER OPTIC FUSION SPLICING MACHINE KIT



High quality fusion splicing



Fusion splicing finish

Specifications	TE-8202A-W
Applicable Fibers	SM, MM, NZDS, EDF
Average Splice Loss	0.02dB(SM), 0.01dB(MM), 0.04dB(NZDS), 0.04dB(EDF)
Splice Time (sec.)	10 sec. (for SM fiber)
Return Loss	≥60dB
Diameter of fiber optic	Cladding diameter:80-150μm, Coating diameter:100-1000μm
Tension Test	2.0N(200gf)(Standard)
Splicing Program	50 groups
Heat Shrinkable Tube	20mm, 40mm, 60mm
Memory Capacity	6000 memories
Battery low indication	4pcs led light indication
Environmental Conditions	-10~+50°C (operation temperature), 0~95% RH(humidity), 0~5000m(altitude)
Power Supply	AC adaptor: 100~240V input voltage, 50/60Hz; Output:DC 15V, 4A
Standard plug	A type
Battery	11.1V 5.2AH
Dimensions	130x135x130mm / 5"x5.3"x5"
Weight	2250g (battery included)

Individual packing: Color label



New developed technology

- Provides strong protection from wind and dust

Heat shrink tubing protection

- Average tube-heat time: 30 second

Hi-resolution output

- 5" colorful LCD display.
- Separate X or Y axis views with 300 times magnification.
- Cutting-edge technology for image processing.

High quality fusion splicing

- Auto / manual/ full auto focus functions
- Advanced core to core alignment
- Average splice time:10 second



USB port
B type-for updates & result transfers

Removable and Rechargeable Li-ion battery

Battery power indication support 180 times splicing and heating.

Standard Package:

Fusion splicing machine, AC adaptor, Battery(in the machine), Spare electrodes, 60mm Shrinkable tube 25pcs, Cooling tray, Quick reference guide, Carrying case with carrying strap

MT-7610A OPTICAL TIME DOMAIN REFLECTOMETER

Specifications	MT-7610A
Optical fiber type	SM optical fiber
Dynamic range	24dB(1310nm) / 22dB(1550nm)
Wavelength	1310nm±20nm, 1550nm±20nm
Optical fiber connector	SC/PC, (FC/PC - ST/PC Optional)
Display	3.5 inch color LCD
Display resolution	320x240
Measuring distance (km)	0.37~80
distance uncertainty (m)	±(0.8+0.005%*distance+Sampling resolution)
Pulse width	10ns~10us
Measurement time	5s~180s
Attenuation blind area	15m(@minimum plus width)
Event blind area	3m(@minimum plus width)
Loss threshold (db)	0.05dB
loss resolution (db)	0.01dB
sampling resolution (m)	0.4 to 1.6
Sampling points	Up to 70866
Typical real-time refresh (hz)	2
data storage	micro SD card(4GB), support 16GB, 25000records
Communication connector	mini USB
VFL power	1mW(650nm±10nm)
Power source	Rechargeable Lithium Polymer battery 7.4v 3100mAh
Battery working time	standby>15hours, continuous measuring>8 hours
Adaptor	INPUT AC 100~240 50/60Hz; OUTPUT: DC12V/2A
Auto power off	yes
Low battery warning	Indication for low battery energy
Operation voice prompts	no
Back light	yes
Operation temperature	0~+50°C; <90%RH
Storage temperature	-20~+70°C; <90%RH
Size	195x110x60mm / 7.7"x4.3"x2.4"
Weight	600g
Package	Color box

Individual packing: Color box



Wavelengths supported
1310, 1550nm

Visually locate events
to help quickly troubleshoot

3.5 inch color TFT LCD
OTDR simulation software
Short test time and fast analysis
PC link system
Rechargeable Lithium Polymer battery



Measurement Interface



PN-378D | 8PK-378C | 8PK-378A | ADJUSTABLE LOCKING PLIER



PN-378D ▲
10" Adjustable Locking Plier



8PK-378C ▶
7" Adjustable Locking Plier



8PK-378A ▶
5" Adjustable Locking Plier



- The forged jaws have an angled tooth pattern for superior grip and built-in wire cutter.
- The handle features a compound action non-slip lock and release lever for one-hand operation.
- With precision-machined jaw adjustment screw to fit work.
- Heavy duty model, provides maximum contact for holding round, flat, square, or hex material securely.



Model No.	Material		HRC	Clamping width	OAL. (mm)
	Head	Handle	Body		
PN-378D	SAE 4140 Cr-Mo alloy steel	SAE 4135 Cr-Mo alloy steel	50°±3°	Round:Ø8.5~50mm, HexØ8.5~43.3mm	224(10")
8PK-378C				Round:Ø7.3~37mm, HexØ7.3~32.04mm	180(7")
8PK-378A				Round:Ø5.4~24mm, HexØ5.4~20.78mm	140(5")

Individual packing: Blister Card

PN-378E | 8PK-378B | LONG NOSE LOCKING PLIER



PN-378E ▶
9" Long Nose Locking Plier



8PK-378B ▶
6" Long Nose Locking Plier



- Long, straight nose provides easy access in narrow and hard-to-reach places.
- The handle features a compound action non-slip lock and release lever for one-hand operation.
- With precision-machined jaw adjustment screw to fit work.
- Heavy duty model, provides maximum contact for holding round, flat, square, or hex material securely.



Model No.	Material		HRC	Clamping width	OAL. (mm)
	Head	Handle	Body		
PN-378E	SAE 4140 Cr-Mo alloy steel	SAE 4135 Cr-Mo alloy steel	50°±3°	Round:Ø7.5~41mm, HexØ7.5~35.41mm	225(9")
8PK-378B				Round:Ø5~19mm, HexØ5~14.45mm	160(6")

Individual packing: Blister Card

PN-378F | PN-378G | CLAMP LOCKING PLIER



PN-378G ▲
11" Clamp Locking Plier

PN-378F ▶
6" Clamp Locking Plier



- C clamp with a deep throat ideal for larger, bulkier items where more clamping capacity is needed.
- The handle features a compound action non-slip lock and release lever for one-hand operation.
- With precision-machined jaw adjustment screw to fit work.
- Perfect for clamping material while marking, welding, brazing, soldering and more.

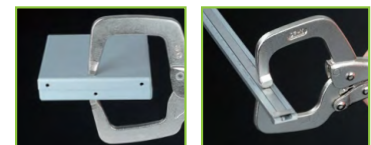

Model No.	Material		HRC	Clamping width	OAL. (mm)
	Head	Handle	Body		
PN-378G	SAE 6140 Cr-V steel	SAE 4135 Cr-Mo alloy steel	50°±3°	Square85.6mm	275(11")
PN-378F				Square 47mm	150(6")

Individual packing: Blister Card

CP-147 4 IN 1 LONG NOSE ELECTRICIANS PLIER

Multi-function: Cutting / Stripping / Crimping / Pulling / Gripping.

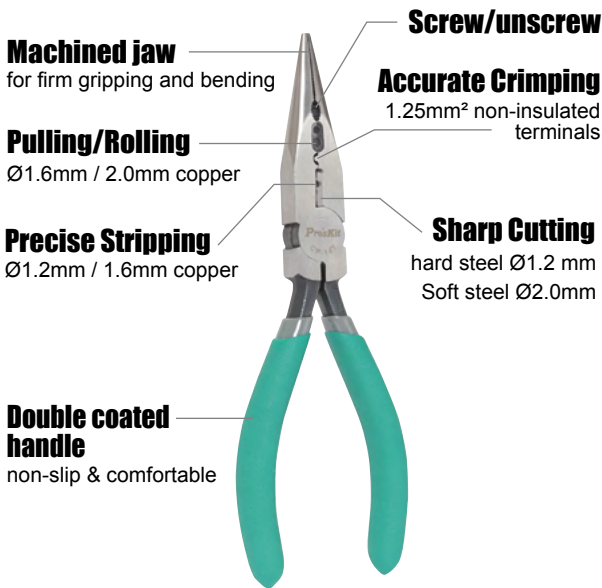

	Material		HRC		OAL. (mm)
	Body	Handle	Body	Cutting edge	
	55Cr-Ni steel	PVC	HRC 43°±3°	HRC 60°±5°	163 (6.4")
Applications	Crimping 1.25mm ² non-insulated terminals. Pulling and rolling Ø1.6mm and Ø2.0mm copper. Stripping Ø1.2-1.6mm solid wire. Cutting Ø1.2 mm hard steel, Ø2.0mm soft steel.				

Individual packing: Blister Card

PN-P110

RAPTOR 10" PUMP PLIER

Ideal for hardware, plumbing, auto repair field



2X Faster Adjustment

Jaw open (Max) 45mm(1.8")

Push button Ratcheting System

Gives rapid & improved precision positioning.

High leverage Force saving



Material	HRC		Jaw open (Max)	Jaw depth (Max)	OAL (mm)
	Body	Jaw			
55Cr-Ni steel	38°±3°	55°±5°	45mm (1.8")	37mm (1.5")	253 (10")

Individual packing: Blister Card

CP-321 UNIVERSAL COMPRESSION TOOL

Perfect for the termination needs in Satellite TV, CATV, Home Theater, and Security applications.

- For crimping most connectors F, BNC, RCA on RG59, RG6 and RG11 coaxial cables.
- Quick, reliable multi-type compression connector for installations.
- Easily adjust compression distance.
- Integrated handle lock for easy storage.
- Extra small size cable holder for convenient operation.



Specifications	Close A+/-0.2mm		Open B+/-0.2mm	
	Max.	Min.(ref)	Max.	Min.(ref)
Connector				
RJ11	51.6	35.6	60.2	44.5
RJ59-6	32.8	18.5	41.7	25.6

Material	HRC	Handle	Application	OAL. (mm)
S45C	45°±5°	ABS	For crimping F, BNC, RCA on RG59, RG6 and RG11 coaxial cables	165 (6.5")

Individual packing: Blister Card

INTERCHANGEABLE CRIMPING TOOLS



300-096
Ergo-Lunar
Crimp Frame



300-054
Lunar
Crimp Frame



902-085
CrimPro Crimp
Frame



CP-3005F
Quick Interchange
Ratcheting Crimper
Frame

DIE Set	Crimp die profile	Application	Crimp Size	Terminals	Description	Model No.
Modular Connectors						
		8P8C/RJ45 keyed modular plugs (excluding AMP)			Lunar frame w/die	300-012
					Ergo-Lunar frame w/die	300-126
					Crimpro frame w/die	902-140
					Die Only	300-042
		RJ11 - 2, 4, 6 pin Modular plugs			Lunar frame w/die	300-027
					Ergo-Lunar frame w/die	300-127
					CrimPro frame w/die	902-151
					Die only	300-053

902-548

QuikThru™ PROFESSIONAL CRIMP TOOL



Simply squeeze the tool to crimp on your CAT5 or CAT6 connector and trim off all excess wire. Also works with standard RJ11 & RJ45 plugs.



902-547
QuikThru Replacement
Blade Set, for 902-548

Specifications	902-548
Application	Works with QuikThru connectors to easily sort and assure proper wiring configurations
Replacement blade	902-547 (5pcs/pack)

QuikThru™ CONNECTORS

It's So Easy!
No More Bad Crimps!
Time Saving!

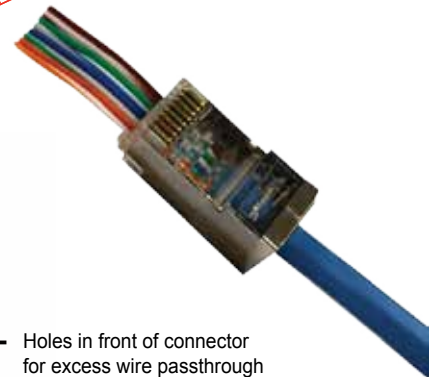

← Holes in front of connector for excess wire passthrough and EASY sorting.

↑
3 Prong, 50µ gold contacts-the best!
Works on solid & stranded wire.

Model	Qty / Description
902-549	QuikThru CAT5/5e Connector, Bulk Bagged (min 500 pcs)
902-549-50	QuikThru CAT5/5e Connector, Retail Pack - 50 pcs
902-549-100	QuikThru CAT5/5e Connector, Jar of 100 pcs
902-550	QuikThru CAT6 Connector, Bulk Bagged (min 500 pcs)
902-550-50	QuikThru CAT6 Connector, Retail Pack - 50 pcs
902-550-100	QuikThru CAT6 Connector, Jar of 100 pcs
902-551	QuikThru CAT5e/6 Connector, Bulk Bagged (min 100 pcs)
902-551-10	QuikThru CAT5e/6 Connector, Retail Pack 10 pcs
902-551-50	QuikThru CAT5e/6 Connector, Retail Pack 50 pcs

902-540

PNEUMATIC CRIMPER

- Reduce repetitive motion injuries
- Safety shield included
- Crimps very quickly without effort
- Includes hook up hose from unit to foot pedal (x2)
- Does NOT include hookup hose and fitting unit to compressor - Needs 5/16" OD PVC hose & nipple
- Many other dies sets are available

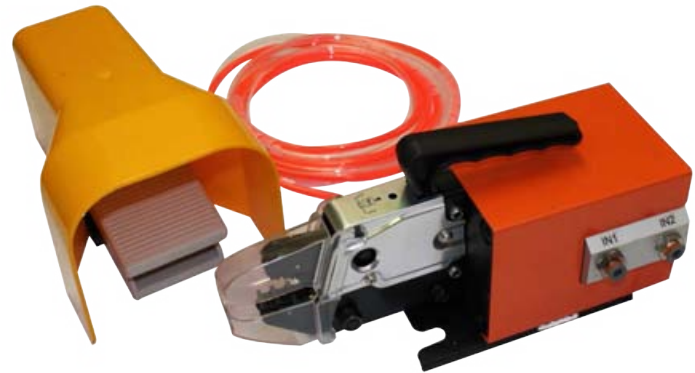

Ideal for those working on assembly lines or performing high volumes of crimps.

Specifications	902-540
Application	Insulated Terminals Red: AWG 22-18 Blue: AWG 16-14 Yellow: AWG 12-10 • Other crimp dies available
Output force	1.35 tons
Input air pressure	58-100 psi
Dimensions	10.25" x 4.75" x 5.5"
Weight	9 lbs

902-544 **HYDRAULIC DIELESS CRIMPING TOOL**

- Non-interchangeable crimping die, wide crimping range
- Automatic pressure release when crimping is complete
- Open crimping head, rotates 360°
- Two stage hydraulics
- Manual retract after crimping



Specifications	902-544
Crimping force	6 Ton
Crimping range	AWG 6-500MCM
Stroke	1.38"
Oil capacity	145cc
Weight	11 pounds
Package	plastic box

902-541 BATTERY OPERATED CRIMPER



- Microcomputer control system.
- Pressure releases automatically when the pressure reaches maximum.
- It is equipped with a double piston, transfers high pressure automatically by slow crimping.
- 350° rotating crimping head for better access to tight corners and difficult working areas.
- Tool automatically stops working when the temperature over 140°F.
- Li-ion batteries feature best performance.
- Includes 12 hex crimping die AWG 6 through 750MCM to satisfy most applications.

Specifications	902-541
Crimping force	12 Ton
Stroke	1.65"
Crimp/charge	120times(Cu 300MCM)
Crimping cycle	6s-8s(depend on the size of cable)
Capacity	3.0Ah
Voltage	18V
Charging time	2hours
Package	plastic box
Accessories	
Crimping dies AWG6, 4, 2, 1/0 thru 4/0, 300, 350, 500, 600, 800MCM	
Battery	2pcs
Charger	1pcs

902-542 BATTERY OPERATED DIELESS CRIMPER



- Microcomputer control system.
- Pressure releases automatically when the pressure reaches maximum.
- It is equipped with a double piston, transfers high pressure automatically by slow crimping.
- 350° rotating crimping head for better access to tight corners and difficult working areas.
- Tool automatically stops working when the temperature over 140°F.
- Li-ion batteries feature best performance.

Specifications	902-542
Crimping range	Up to 500MCM
Crimping force	6 Ton
Stroke	1.38"
Crimp/charge	250times(Cu 300MCM)
Crimping cycle	3s-6s(depend on the size of cable)
Capacity	3.0Ah
Voltage	18V
Charging time	2hours
Package	plastic box
Accessories	
Battery	2pcs
Charger	1pcs

VDE 1000V INSULATED TOOLS



Pro'sKit® constantly fulfill in 14 series more than 100 items including: sockets, T-handles, extension bars, hex key wrenches, torque wrenches, cable cutters, knives, scissors, tweezers.



SR-V210
Cable
Cutter



SR-V537
Ratchet
Cable Cutter



SR-V336
Electricians
Scissors



PD-V004A
Cable
Knife



HW-V6 Series
Adjustable
Wrench



HW-V7 Series
Reverse
Ratchet Handle



SK-V8 Series
Extension
Bar

Application: for cutting copper and aluminum cables Ø10.0mm / 80mm² / AWG3/0

Application: for cutting copper and aluminum cables Ø32mm / 240mm² / 500MCM

Cable cutter

Model No.	Material	HRC		OAL.
		Body	Cutting edge	
SR-V210	Cr-Mo	40°±3°	50°±2°	250mm(9.8")
SR-V537	65Mn	38°~43°	48°~52°	240mm(9.4")

Scissors & knife

Model No.	Material	HRC	Blade length	OAL.
SR-V336	AISI 420J2	40°~52°	47mm(1.85")	160mm(6.3")

Model No.	Material	HRC	Blade length	OAL.
PD-V004A	3Cr13	50°~58°	50mm(1.77")	180mm(7")

Socket wrenches

Model No.	Material	Jaw open (Max.)	Jaw depth	Jaw thickness	OAL.
HW-V608	50CrV	30mm(1.2")	25mm(1")	12-8mm (0.47"-0.3")	200mm(7.9")
HW-V610		34mm(1.3")	30mm(1.2")	14-9mm (0.55"-0.35")	250mm(9.8")
HW-V612		41mm(1.6")	36mm(1.4")	17-11mm (0.67"-0.43")	300mm(11.8")

Model No.	Material		Square drive	Teeth	OAL.
	Body	Square drive			
HW-V708	AISI 6140	42CrMo	9.5mm(3/8")	36	200mm(7.9")
HW-V710			12.5mm(1/2")	36	250mm(9.8")

Model No.	Material	Square drive	OAL.
SK-V831	50BV30	9.5mm(3/8")	125mm(4.9")
SK-V832		9.5mm(3/8")	250mm(9.8")
SK-V851		12.5mm(1/2")	125mm(4.9")
SK-V852		12.5mm(1/2")	250mm(9.8")

Individual packing: Blister Card

SOLDERING

NEW

SS-256EU **SS-259EU**

LCD SMART SOLDERING STATION



- Microprocessor controlled
 - Features best performance and accurate temperature control.
 - Temperature calibration function
 - Auto sleep and wake up function, system lock, tip calibration and low power consumption.
- Large LCD display with shuffle knob design
- 3 data memories
- USB 5V/1A power output



Microprocessor controlled
Alumina ceramic heater

High end silver alloy heater
Heat fast 19 sec reach 300°C



Specification	SS-256EU	SS-259EU
Input voltage	AC 110~120V / 60Hz	AC 110~120V / 60Hz
Control system	Microprocessor-controlled	Microprocessor-controlled
Power consumption	60W	90W
Display	LCD 73mmX40mm, Backlight	LCD 73mmX40mm, 240X120 dot. Backlight
Temperature range	200~480°C / 392°F~896°F	30~500°C±10°C / 86~932°F±50°F
Temperature calibration	100~699°C(212~1290°F), Adjustable	0~699°C(32~1290°F), Adjustable
Temperature stability	±2°C/±36°F (no load)	±2°C/±36°F (no load)
Heating element	Alumina ceramic	High end silver alloy heater
Sleep mode	OFF/1-240min adjustable	OFF & 1~360min adjustment
Output voltage	24VAC	25VAC
Temperature of sleep mode	200°C/392°F	30~400°C/86~752°F
USB port output	DC 5V/1A	DC 5V/1A
Memory	3 sets	3 sets
Tip-to-Ground resistance/potential	≤2Ω/≤2mV	≤2Ω/≤2mV
Replacement heater	9SS-900N-HT	9SS-259-HT
Soldering iron	9SS-256-SI	9SS-259-SI
Size	180 x 150 x 106mm / 7"x6"x4.2"	180 x 150 x 106mm / 7"x6"x4.2"
Weight	4.6 lbs	5.1 lbs

Individual packing: Color box

SOLDERING

NEW

SI-132A WOOD BURNING HOBBY KIT



Ideal for woodburning, embossing, leather working and home DIY soldering repair.

Comes with 25 Watt heating pen featuring screw-in tips especially designed for craft use. Made with a nickel-chrome heating element heats up fast and temperature up to 360°C.

25W
360°C



Leather working

Woodburning

Voltage	Power	Soldering Temperature	Plug
110-120V	25W	360°C	A

Individual packing: Color sleeve



21 in 1
8 pcs wood burning tips
11 pcs embossing tips
1 pc solder tip
1 pc blade
Tool stand included

SI-B162 BATTERY OPERATED SOLDERING IRON

New switch design with safety cap detent
Auto power off when cap attached
Fast heat up performance



8W
450°C

Specifications	SI-B162
Consumption	Max. 8W
Temperature	Max. 450°C (with alkaline battery)
Time to reach operating temperature	in 15-20 seconds (with alkaline battery)
Battery	3 x 1.5V alkaline AA (not included)
OAL	178mm / 7" (without cap)
Accessories	Lead free solder wire: 9SI-B162-W Replacement tip: 9SI-B162-T

Individual packing: Blister card



Auto power off when cap attached

PT-1362U **USB LI-ION CORDLESS SCREWDRIVER 3.6V**



Full metal gearbox
Powerful 350RPM/3 Nm Motor
Japan SANYO Li-ion battery



Powerful 350RPM/3 Nm Motor

Provides plenty of power for a variety of applications

Full metal gearbox

The durable metal gear features small volume, high torsion and not easy to wear.

Japan SANYO Li-ion battery

MT-1362U uses SANYO power cell series li-ion battery, offers high performance and long service life

Compact Design

For easy access in tight spaces

LED light

Provides increased visibility in dark areas

Charging protection circuit board

Design for quickly charging and over current protection



USB charging



Full metal gearbox



Japan SANYO Li-ion battery

Model No.	PT-1362U
Rated no load speed	350 rpm
Output torque	3 Nm (31 kgf-cm/26.9 lbf-in)
Special function	LED charging indicator
Overall length: angled	140(L)x110(H) mm
Battery	Li-ion 3.6V 1100 mAh
Charging time	1.5~2 hours (5V/2A)
Free running time	30 min
Accessories	5pcs 50mm driver bits: ⊖ 6.0 ⊕ #1, #2 ● 3.0, 4.0 Micro USB charging cord

Individual packing: Double blister card

902-543 **HYDRAULIC SWIVEL HEAD PUNCH SET**

- Lightweight design for portability and fast, easy one person operation.
- 7 Ton hydraulic force for easy punching (10 Gauge Mild Steel)
- Punching head rotates 360 degrees for flexibility in tight working areas.



Specifications	902-543
Punching force	7 Ton
Stroke	1"
Weight	4.6 lbs(without box and accessories)
Package	plastic box
Weight of box	2.64 lbs
Accessories:	
Round Knockout Punches Type D	0.885, 1.115, 1.362, 1.701, 1.951, 2.416 inches
7/16"x3/4" Draw Stud	1pc
3/4"x3/4" Draw Stud	1pc
Spacer	1pc
Plastic box	1pc

Individual packing: Label

902-545 | 15 TON HYDRAULIC KNOCKOUT PUNCH SET

- Two-piece design allows head to get into tight spaces.
- Punch/Die sets are easily changed, leave no burrs or rough/sharp edges.

Specifications	902-545
Punching range	0.885 - 2.416 inch, up to 10 Gauge Mild Steel
Punching force	15 Ton
Stroke	1.0"
Weight	15.6 lbs
Package	steel case
Weight of box	9.7 lbs
Accessories:	
Round Knockout Punches Type D	0.885, 1.115, 1.362, 1.701, 1.951, 2.416 inches
Square Knockout Punches	1.25"x1.25"
7/16"x3/4" Draw Stud	1pc
3/4"x3/4" Draw Stud	1pc
Spacer	1pc
Plastic box	1pc

Individual packing: Label



902-546 | PUNCH SET, 3 POINT PUNCH STYLE

- Capacity: Mild steel up to 3.5mm (10 Gauge)
(Can cut Stainless Steel, but punches will wear much faster)
- Application: Punch mild steel, aluminum, fiberglass and plastic.
- Operation: Only to be used with 15 Ton Punch Driver Kit (part number 902-545)



Conduit & pipe size	Hole Size(Actual)	Capacity
3"	3.5"	10 GA
3.5"	4"	10 GA
4"	4.5"	10 GA

902-306 ACSR RATCHET CUTTER

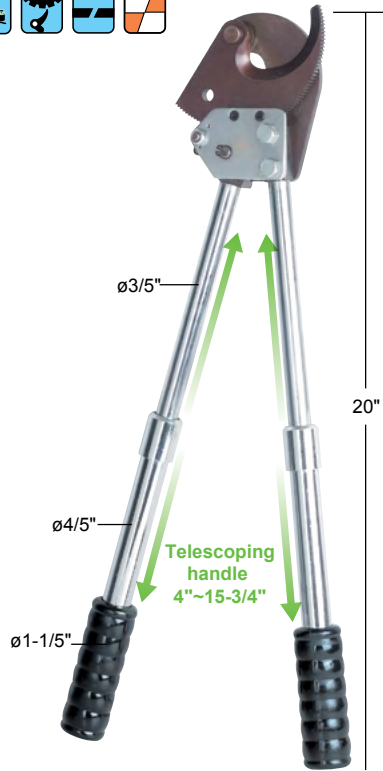

Ideal cutting capability



Ratchet release design



Packaged with a bag

- Ideal for cutting steel wire, low carbon steel bar and aluminum cable.
- Blade return is available during cutting.
- Ratchet mechanism for convenient handle operated control.
- With heavy duty blade.
- Dimension: 13-2/5" x 5" x 1-1/2"

Application



Specifications	902-306
Material body	S45C
Material blade	SAE 4340
HRC cutting edge	45°±3°
Application	750MCM(300mm ²) copper and aluminum cable
Replacement blade	5SR-538-RB (Moving blade) 5SR-538-FB (Fixed blade)
Dimensions	280mm / 11"

Individual packing: Inner box+color label

IPHONE SERIES POSITION SCREW BOARD

The phone screw position board has a layout with a printed iPhone on top and holes to put in the screws at the right position. So it can help you always remember the position of each screw and it prevents you from mixing or losing them.



5 pcs / box
MS-5156 5PCS boards in 1 set

Model No.	Suitable for iPhone model	Packing
MS-I52	2Pcs screw position boards for iPhone 5	2PCS/blister card
MS-I5S2	2Pcs screw position boards for iPhone 5S	2PCS/blister card
MS-I62	2Pcs screw position boards for iPhone 6	2PCS/blister card
MS-I6S2	2Pcs screw position boards for iPhone 6S	2PCS/blister card
MS-I6SP2	2Pcs screw position boards for iPhone 6S plus	2PCS/blister card
MS-5156	5Pcs screw position boards for iPhone 5/5S/6/6S/6S plus (qty one each)	5PCS/color box

HOOK & LOOP CABLE TIE

Eclipse hook and loop cable ties are made of Nylon/P.P. They are good to use in binding cables and patch cables and will not affect the transmittance performance because of pinching caused by over tightening.



902-554 902-555 902-556 902-557

Description	Width	Moled No.	Color
Hook & Loop Cable Tie 50Ft	3/4" wide	902-554	Orange
		902-555	Yellow
		902-556	Aqua
		902-557	Violet

INNOVATION • QUALITY • SERVICE

Pro'sKit® is an international brand of total solution provider for tools and tool kits in electronic, electrical, computer, networking & telecom fields in the worldwide market. **Pro'sKit**® has been developing its product lines and expanding its business with the policy of innovation, quality and service.

Quality is the foundation of **Pro'sKit**® brands. As an ISO9001:2008 certified manufacturer since 1998, all **Pro'sKit**® products meet or exceed quality standards and quality control procedures conform to the strict requirements of the standards. There is nothing that cannot be further improved. **Pro'sKit**® always adheres to its quality policy & high standard and will continue to enhance the capability.

Most of **Pro'sKit**® electronic power products are qualified by CE or GS, TUV and **Pro'sKit**® has been devoted to conforming to RoHS since 2006 per the European Union's regulation that secure **Pro'sKit**® high product quality for our customers throughout the world.



Computerized SOP Production Line



Handheld XRF for RoHS Compliance Testing



Lifetime Testing Machine



Burst Strength Tester



Reliability Test

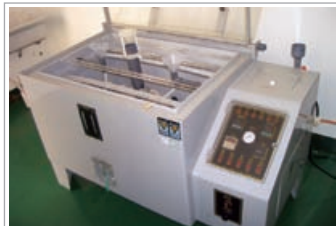

Salt Spray Test



Torque Testing Machine



High Compliance Multi-Product Calibrator



TÜV S.A.A.

BS



Pro'sKit® Symbols

	Wire spring		RS232 D-sub round barrel contact pins or sockets		TRI-wing		Duty Cycle
	Leaf spring		Insulated & non-insulated wire ferrules		Ball hex		Relative reference
	Flat		Hex type coaxial & fiber optic connectors		Star		Continuity buzzer
	Half-round		Oval type coaxial & fiber optic connectors		Square tamper proof		Continuity check
	Round		Square type coaxial connectors center contact pins		Torx® plus 5 star		Diode test
	Stripping flat telephone cables		Crimping pressure adjustment		Torx® plus socket		Transistor hFE test
	Stripping twisted pair round cables		Ratcheting release knob		Pentalobe star tip		LED test
	2 blade stripping coaxial cables		Ratcheting release trigger		Square drive socket		Battery check
	3 blade stripping coaxial cables		Force-saving design		Bi-hexagon socket		Inductor check
	Mini bevel		Ratcheting force-saving design		Needle type bits		Backlight
	Full flush		Black tip		ESD safe		Maximum/Minimum value
	Extra full flush		Slotted		Non-magnetic		Maximum value hold
	Cross Cut		Phillips		Magnetic		Data hold
	Serrated		Torx®		Safety caution		Auto power off
	Smooth		Torx® tamper proof		Insulated		Low battery
	Crosswise serrated		Hex		1KV insulated protection		Zero-ohm adjuster
	4 pin(RJ22) telephone handset plugs		Hex tamper proof		RoHS directive		Output terminal
	6 pin(RJ11/RJ12) telephone plugs		Nut		Lead free		RS232C connector
	8 pin(RJ45) modular plugs		Pozidriv		Complied with IEC/EN 60529 IP54 test		USB connector
	10 pin(RJ50) modular plugs		Triangle		DC voltage		Hygrometer
	Telecom splice connectors		Spanner nut		AC voltage		Thermometer
	Pin terminal, insulated & non-insulated ferrules		Spanner		DC current		Light meter
	Insulated & non-insulated wire ferrules		Torq		AC current		Sound level meter
	Non-insulated terminals & lugs		Wing nut driver		Resistance		Class2, double insulated
	Open barrel, non-insulated terminals & lugs		Phillips tamper proof		Frequency		A type AC110V~120V
	D-Sub terminal & Non-Insulated Open Barrel Connectors		Clutch		Capacitance		E type AC110~120V
	Insulated terminals, Insulated & Uninsulated Flag		Spline		Temperature °C/F measurement		
	Insulated terminals		Square		Temperature °C measurement		

Torx® is a registered trademark of Camcar Textron

All rights reserved. Reproduction in whole or in part in any language without permission is prohibited.
Printed in Taiwan, March, 2016. First Edition
©2016 ProKit's Industries Co., LTD.

CONTENTS

TEST INSTRUMENTS

P.4-25



ESD STATIC PROTECTION

P.124-125



PRECISION PLIERS & CUTTERS

P.26-38



TWEEZERS

P.126-129



ELECTRICAL PLIERS & CUTTERS

P.39-46



MAGNIFICATION & LIGHTING

P.130-139



KNIVES, SCISSORS & SAWS

P.47-50



POWER TOOLS

P.140-143



CRIMPERS

P.51-68



HOLE MAKING

P.144-145



HYDRAULIC CRIMPERS

P.69



FIBER OPTICS

P.146-152



STRIPPERS

P.70-78



MISCELLANEOUS

P.153-160



PUNCH DOWN TOOLS

P.79-81



CONNECTORS

P.161-167



SOLDERING & ASSEMBLY

P.82-94



WIRING INSTALLATION

P.168-173



SCREWDRIVERS / BITS

P.95-113



STORAGE/INSTRUMENT CASES

P.174-177



1/4" INCH HEX HIGH QUALITY BITS

P.114-115



TOOL CASES

P.178-186



HEX KEY WRENCHES

P.116-118



TOOL KITS

P.187-211



SOCKET WRENCHES

P.119-123



INDEX

P.212-216



MT-8100 Butt Set



Features:

- High impedance monitor
- Line voltage test
- Line Continuity test
- Polarity indication
- Two-way hands-free speakerphone
- Tone and pulse operation
- Speed dialing
- Last number redial
- PBX pause button
- Mute switch
- Electronic adjustable Volume
- Auto power off
- Low battery indication
- Audible ring
- Extra large steel locking belt clip
- Angled bed of nails and RJ11 plug



Waterproof



Dustproof

- Drop Protection
- Rugged
- Exterior
- Voltage Test

IEC/EN 60529
IP54

Mark for products that comply with IEC/EN 60529
IP54 Dustproof & Waterproof tests

Electrical	
Loop limit	2 K Ω maximum at 48 VDC (nominal 20 mA minimum loop current)
DC resistance	
Talk mode	300 Ω typical
Monitor impedance	39k Ω nominal at 1 kHz
Rotary dial output	
Pulsing rate	10pps+0.8pps
Percent break	61% \pm 2%
Interdigit interval	1000 ms typical
Leakage during Break	>50 k Ω
DTMF output	
Tone frequency error	\pm 1.2% maximum
Tone level	-8 \pm 2dBm combined (typical)
High versus low tone difference	4 dB maximum
Memory dialing	
Memory capacity	13 memories including M1, last number redialing
Digit capacity	16 digits per memory
PBX pause duration	4 seconds
Line voltage test	5 Phase AC/DC voltage indication (under24V,24~100V,101~150V, 151~200V,more than 200V)
Monitor amplifier	9V transistor; provides 25 hours continuous use, typical
Power source	Continuous use, typical
Automatic power shut off(Monitor type)	After 5 min. of no audio signal
Speaker phone levels	Electronically adjustable
Fuse	250V, 250mA
Power source	Battery (9V) 6F22 (Not included)
Physical	
Measurement	230 x 82 x 89mm (9.1" x 3.2" x 3.5")
Weight	635g typical
Water resistance	Dust protection & Waterproof tested to an IEC/EN 60529 IP54 rating
Cord sets	Angled bed of nails and RJ11 plug
Environmental	
Temperature	Operating: 0 to 50°C Storage:-10 to 60°C
Altitude	To 10,000 feet (3,000M) max
Relative humidity	5 To 95%

Individual packing: Color box



400-042 Butt Set



Rests easily on shoulder



Polarity LED indications

Large multi-functional panel



Angled bed of Nails



Durable hanger



CE RoHS COMPLIANT AP OFF High impedance monitor, Polarity indication

Features:

- Recognized as the new industry standard, the 400-042 butt set provides superior quality at an affordable price.
- With its high impedance monitor for data safe operation, technicians can clip onto a line in Monitor mode without disrupting existing traffic.
- **Proskit** unsurpassed protection standards and durability assure the butt set will keep working even in the toughest environments.
- New weatherproofing provides enhanced resistance to severe weather conditions.

Electrical	
Loop limit	2 kΩ maximum at 48 VDC (nominal 20 mA minimum loop current)
DC resistance	
Talk mode	300Ω typical
Monitor impedance	39kΩ nominal at 1 kHz
Rotary dial output	
Pulsing rate	10pps±0.8pps
Percent break	61%±2%
Interdigit interval	1000 ms typical
Leakage during break	>50 kΩ
DTMF output	
Tone frequency error	±1.2% maximum
Tone level	-8±2dBm combined(typical)
High versus low tone difference	4 dB maximum
Memory dialing	
Memory capacity	12 memories plus last number redialing
Digit capacity	16 digits per memory
PBX pause duration	4 seconds
Monitor amplifier power source	9V transistor; provides 25 hours continuous use, typical
Speaker levels	Low, medium, high
Automatic power shut off	After 5 min. of no audio signal
Speaker phone levels	Low, medium high
Fuse	250V, 250mA
Power source	Shared line and battery power
Physical	
Length	10.2"(26.0 cm)
Width	2.8"(7.0 cm)
Height	3.5"(8.90 cm)
Weight	560 g typical
Environmental	
Temperature	Operating: 0 to 50° C Storage: -40 to 66° C
Altitude relative humidity	To 10,000 feet 5 to 95%

Individual packing: Color box

900-244 In-Line Modular Adapters (4/6/8 Pin 3 In 1)

RoHS COMPLIANT

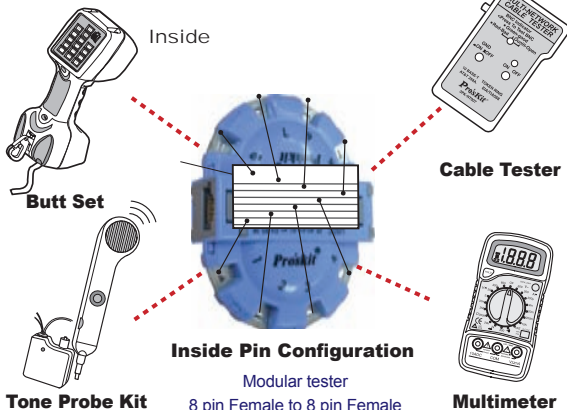

Features:

- The 900-244, In-line Modular Adapter allows in-line testing for any plug/jack combination. It includes two 4-pair jacks plus a modular cord terminated with 4-pair "universal" plug for accessing any standard 6- or 8-position jack.
- Individual conductors are broken out by pin number and correspond to eight separate test pads.
- Test equipment can be securely attached to the test pads using alligator clips.
- For quick reference in the field, USOC, T568A, and T568B wiring charts are printed right onto the body.



	6 pin Female to 8 pin Male		8 pin to 8 pin 205mm
	4 pin Female to 8 pin Male		8 pin to 6 pin 205mm
			8 pin to 4 pin 205mm

Individual packing: Blister card

MT-8006B Data Diver

CE **RoHS COMPLIANT** LCD display, Talk/Monitor, Polarity indication, Power saving, Hands-Free

Features:

- LCD display for dialing number, Caller ID, Clock and other information
- Indicator for determining the line service
- Smart power saving enables battery life up to 6 months
- 12 phone number memory for speed dialing
- 16 dialing number memories
- Tone (DTMF) and pulse operation
- Up to 32 digits phone number memory for speed dialing key
- Pre-dialing and last number redial function
- PBX pause key, insert a PBX pause in stored numbers
- Telephone line polarity indicators
- Low battery indication
- Backlight function
- RJ-11 port for easy test leads change
- Ringer and voltage LED indication
- Angled bed of nails and RJ-11 plug

Electrical	
Loop limit	2 K Ω maximum at 48 Vdc (nominal 20 mA minimum loop current)
DC resistance	
Talk mode	300 Ω typical
Monitor impedance	>39K Ω nominal at 1 KHz
Rotary dial output	
Pulsing rate	10pps+0.8pps
Percent break	60/40%±2%
Inter digit interval	1000 ms typical
Leakage during break	>130 K Ω
DTMF output	
Tone frequency error	±1.5% maximum
Tone level	-8±2dBm combined (typical)
High versus low tone difference	4 dB maximum
Memory dialing	
Memory capacity	12 memories
Digit capacity	16 digits per memory
PBX pause duration	1-3.6 seconds
Fuse	250V, 250mA
Power source	4pcs 1.5V AAA batteries (not included)
Physical (Hook included)	
Measurement	218.5 × 69.5 × 49mm (8.6" × 2.7" × 1.9")
Weight	208g typical

Individual packing: Double blister



MT-8006VA 3-1/2 Auto Range DCV/DCA Meter

Free with purchase of MT-8006B



Accessories: Angled bed of nails & headset



Telephone line testing



High impedance monitor

400-028 Dual Telephone Line Tester



Features:

This tool is for testing the condition of dual telephone line jacks. Multi-color LED indicator light alerts to okay line, reversed line, AC Voltage present and dead line. Fits in shirt pocket.

- Dual telephone line tester that troubleshoots common problem conditions with standard single or dual-line telephone hook-ups.
- Compact unit easily plugs into any single or dual-line telephone jack.
- Tests for three wiring conditions: correct, reversed and AC voltage presence.

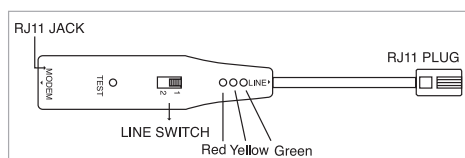

Individual packing: Blister card

902-267 / 902-459

Replacement Test Leads for Butt Set



Features:

- Professional grade "Bed of Nails" insulation piercing clips within the jaws
- Ultra-durable nylon braided jacket
- Guarantee ruggedness and flexibility
- Non-insulated ring terminals

Individual packing: Blister card



902-267



902-459

Model No.	Material	Butt set	Length	Color
902-267	Nylon/copper	400-042	60 inch	Red
902-459		MT-8006B	50 inch	Black

MT-7071 LCD Cable Length Toner & Probe Kit



Including transmitter, receiver and standard remote unit, RJ45 cable patch cord, RJ11/12 cable patch cord, alligator clips patch cord, earbud, carrying bag.



Detects AC Voltage



Wire Tracing



LED light for user convenience



Max support to 8 remote units (optional)



Locate break point and length measurement



Verify LAN/ Telephone/ Coaxial cable condition

The MT-7071 lets you measure cable length up to 1200M (4000ft), locates and verifies the cable status and troubleshoots wiring. Ideal for all installation and maintenance fields of telecommunication, networking, datacom, audio/video, cable TV, and all weather cabling, etc.

Cable Length Measurement up to 1200M

Measures cable length from tester to an open in the cable (break or end) up to 1200M without remote being attached

Calibration Parameters

It can determine actual calibration parameters with known length of cable for cable length test, allows setting 1-7 calibration parameters.

Wire Tracing up to 3KM

Easily track wire directly in connection with live telecommunication equipment and router.

Cable Mapping & Status Indication up to 610M

Display the result of cable mapping and troubleshoot wiring for continuity, short, open and crossover.

Max. support 8 remote units

For cable mapping on RJ45 LAN cable Cat 5,5e,6 (UTP), RJ11/12 Telephone cable Cat. 3 (2/4/6 pin) & BNC connector coaxial cable.

Non Contact Voltage Detection

Tests voltage from 90 ~ 1000V before testing for circuit protection.

MT-7071 Toner specifications	
Cable types tested	RJ45 Lan cable Cat 5, 5e, 6, (UTP/STP), RJ11/12 Telephone cable Cat 3 (2/4/6 pin), Coaxial cable & normal solid/ Stranded wire by alligator clips patch cord
Cable test modes	580/1160 Hz two-note tones for location and isolating cables, wire mapping for validate (detects wire continuity, shorts, opens, miswired, crossover) and open length tested
Measurement technology	Cable capacitance method
Max. distance to open for test	1,200 meter (4,000 feet/1,300 yard), approx
Min. distance to open for test	2 meter (6.8 feet/ 2.2 yard)
Typical accuracy of length test	2~10 meter (6.8~33 feet/2.2~11yard) for reference 10~610 meter (33-2000 feet/ 11~666 yard.): ±5.0% 610~1,200 meter (2000~4000feet/ 666~1300 yard.) for reference, Default measuring Cat.5e cable
Calibration accuracy of length test	10~610 meter (33~2,000 feet/11~666 yard) ±3.0%, standard cable:10~50meter(33~164 feet/11~55 yard), Default measuring Cat.5e cable
Resolution & Unit of length test	0.1 meter/ feet/ yard, Rate:1~3 sec./time
Calibrating parameters memory	1~7 sets, allowing rewrite by new calibrating parameters
Max. distance of transmission & cable map	≥ 3 km (580/1160 Hz) & 610 meter (2,000 feet/666 yard)
Min. distance of cable map	Twisted Pair:1Meter (3 feet/ 1yard), normal wire:1.25Meter (4feet/1.35yard)
Cable map & Shielded indication	LCD 1~8 & G
Other functions	Continuity test, Current protection< 5 mA & voltage protection AC 60V or DC 48V, Live telecommunication equipment test and router test, Auto power off, Low battery display
Dimension (L×W×D)(mm/inch)	138×80×35/5.4x3.1x1.4"
MT-7071 Receiver specifications	
Signal status indication	580/1160 Hz
NCV indication & LED illumination	1 LED (AC90~1000V) & 1 LED
Dimension (L×W×D)(mm/inch)	198×45×33/7.8x1.8x1.3"
MT-7071 Remote unit specifications	
Remote unit	1 pc, max. support to 8 pcs (optional remotes: MT-7071U)
Compatible connectors	RJ45(8 pin), RJ11/12(6 pin), BNC connectors
Remote unit dimension (L×W×D) (mm/inch)	90×32×30/3.5x1.3x1.2"
Individual packing	Color box

MT-7028 Network Toner & Probe Kit



The MT-7028 lets you easily to locate and verify the cable status and troubleshoot wiring for continuity, shorts, opens and crossover on RJ45 LAN cable Cat 5/5e/6/7 (UTP/STP)/RJ11/12 telephone cable Cat. 3 (2/4/6 pin) & normal solid/stranded wire by alligator clips patch cord. Ideal for all installation and maintenance fields of telecommunication, networking, datacom, audio/video, cable TV, and all weather cabling, etc.

Wire Tracing up to 3KM

The tone and probe kit let you easily tracking wire directly in connection with live telecommunication equipment and router

Cable Mapping & status Indication up to 300M

- Fast/Slow scan function for choosing
- Display the result of pin to pin cable mapping
- Display cable status and troubleshoot wiring for continuity, shorts, opens and crossover.

Non Contact Voltage detection

Tests voltage from 90 ~ 1000V, special design to make sure the power is off before testing for circuit protection

Energy saving

Automatically powers off after 1 hour of no operation

Polarity indication

Identify the telephone line polarity easily

MT-7028 Transmitter specifications	
Tone frequency	1kHz
Max. distance of transmission & Cable map	≥3km & 300m
Tone mode	Hi/Low two-note tone
Compatible connectors	RJ45(8 pin)/RJ11(6 pin) compatible connectors for RJ45(8 pin), RJ11/12(6P/2C/4C/6C) cable map and RJ45 tone, RJ-11(6 pin) connectors for RJ11/12(6P/2C/4C/6C) tone
Cable types tested	RJ45 Lan cable Cat 5, 5e, 6, 7 (UTP/STP), RJ11/12 Telephone cable Cat 3 (6P/2C/4C/6C)
Continuity test	1 LED (≅300Ω), Coaxial cable & normal solid/Stranded wire by alligator clips patch cord.
Cable map & Shielded indication	8 LEDs& 1LED , Fast/Slow dual speed
Phone line polarity indication	1 Dual color LED
Other function Live telecommunication equipment test and router test	Live telecommunication equipment test and router test, Voltage protection AC 60V or DC 48V,Auto power off, Low battery display
MT-7028 Receiver specifications	
Frequency & Compatible connectors	1kHz & RJ45(8 pin)/RJ11(6 pin)
Signal status indication	1 LED & Buzzer, ear bud jack
Cable map & Shielded indication	8 LEDs & 1LED
NCV indication & LED illumination	1 LED (AC90~1000V) & 1 LED
Battery type	DC 9.0V (NEDA 1604/ 6F22 DC9V ×1pcs)
Dimension (L×W×D)(mm/inch)	198×45×33/7.8×1.8×1.3"
Individual packing	Color box



RJ45 cable patch cord, RJ11 cable patch cord, alligator clips patch cord, ear bud, pouch bag



Detects AC voltage from 90 to 1000V



Verify LAN/ telephone cable condition



Wire tracing

400-011 Tone Generator and Probe Kit



Use it on de-energized AC wire, telephone/twisted pair wire, all voice and data category rated cable, speaker wire, virtually any cable or wire!

Features:

- Fast, accurate wire identification
- Rugged industrial design
- Sends tone to identify wires
- Three selectable tone outputs
- Two-line polarity indication
- Continuity test
- Adjustable volume control
- Visual signal strength indication
- Powerful speaker for noisy environments
- Recessed telephone test set connectors
- Battery: 9V(6F22) Included

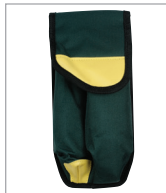

Packaged in a soft nylon carrying case.



Tone Generator

Probe Amplifier

Individual packing: Blister card

902-228 All-in-One Toner & Probe Kit

CE RoHS COMPLIANT CONT. LED VDV Tester (Voice/Data/Video)

Features:

- Validate and troubleshoot wiring on RJ11/RJ45 cables, USB, F, BNC and RCA connectors.
- Detects telephone and Ethernet service, indicates polarity and active line numbers on voice circuits, and active pair number on Ethernet circuits
- Ideal for all maintenance fields of telecommunication, networking, datacom, Audio/Video, Cable TV and all weather cabling, etc...
- Locates cables quickly and easily
- Overcome noise and save time
- Tone on live networks safely and effectively
- Verify conductor continuity with cable map



Toner Specifications	
Tone frequency	1kHz
Tone mode	ONE/TWO-note tone
Compatible connectors	RJ45/RJ11/USB/F/BNC/RCA/Alligator Clips
Continuity test	<300Ω
Talk battery voltage	6V into 600Ω
Function selection	5-position rotary switch
Cable map indication	8 LED indicators
Voltage protection	100V
Low battery display	6.5V
Battery type	9V (6F22) (Included)
Dimension (LxWxD)	140x70x30mm / 5.5"x2.8"x1.2"

Receiver Specifications	
Frequency	1kHz
Compatible connectors	RJ45/RJ11/USB/F/BNC/RCA
Ear jack	1
Signal status indication	8 LED indicators
Cable map indication	8 LED indicators
Low battery display	6.5V
Battery type	9V (6F22) (Included)
Dimension (LxWxD)	250x52x33mm / 9.8"x2.0"x1.3"

Individual packing: Color box



Copper cabling detecting, including shielded (STP) and UTP cable



10 Base-T or 10/100 Base-T datacom networks



Locates and isolates cables quickly and easily



Accessories :
1 zipper bag,
2 RJ45 cables,
2 BNC connectors,
2 RCA connectors.

400-026 Multi-Modular Cable Tester

RoHS COMPLIANT CONT. LED For testing RJ45/RJ11/RJ12/BNC cable



Features:

- Tests RJ45 TIA568A/B (AT&T 258A), 10 Base-T, Token ring, RJ11/RJ12 USOC and Coaxial BNC cable.
- Automatically check cable for continuity, short, open and crossed wire pairs.
- Coaxial cable port identifies cable conditions including shorts, shield opens and center conductor breaks.
- Main unit and remote allow one person testing.
- Power source: DC 9V Battery (Not included)
- Dimension: 102x106x28 (mm) / 4.0"x4.2"x1.1"
- Cable not included

Individual packing: Blister card



Accessories: Pouch bag and BNC connector

MT-7058 Mini Lan Cable Tester

CE  **RoHS COMPLIANT** RJ45, RJ11, RJ12, BNC cable tester, Voltage detector

Features:

- Complies with CE safety standard
- Automatically detect good connections, opens, crossed wires & split pairs
- Test RJ45 TIA568A/B (AT&T) 258A), 10 Base-T, Token ring, RJ11/RJ12 USOC and coaxial BNC cable
- Pin to pin cable map indicator
- Voltage detection for user safety
- Main unit and remote allow one person operation
- Compact size and lightweight design for easy to carry around
- Circuit protection design for both units
- Low power consumption with auto power off function to preserve battery
- Long cable test more than 300 meters(1000ft)

Specifications	
Function	Ground or shielded test
	1-8 LED pin to pin indicator
	No Connection indicator
	Crossover indicator
	Straight cable indicator
	Cable short indicator
	BNC cable indicator
	Non-contact detector(AC60V~240V 60Hz)
	Low battery indicator
	Beeper indicator
Size	100×60×24.5 mm / 3.94"×2.36"×0.96"
Power	12V AE23 x 1pcs (Not included)
Accessory	Pouch bag x 1, BNC connector x 1

Individual packing: Color box



BNC cable test



RJ11 cable test



RJ45 cable test



Long cable test more than 300m(1000ft)



Non-contact voltage detection (AC60V~240V 60Hz)



Accessory

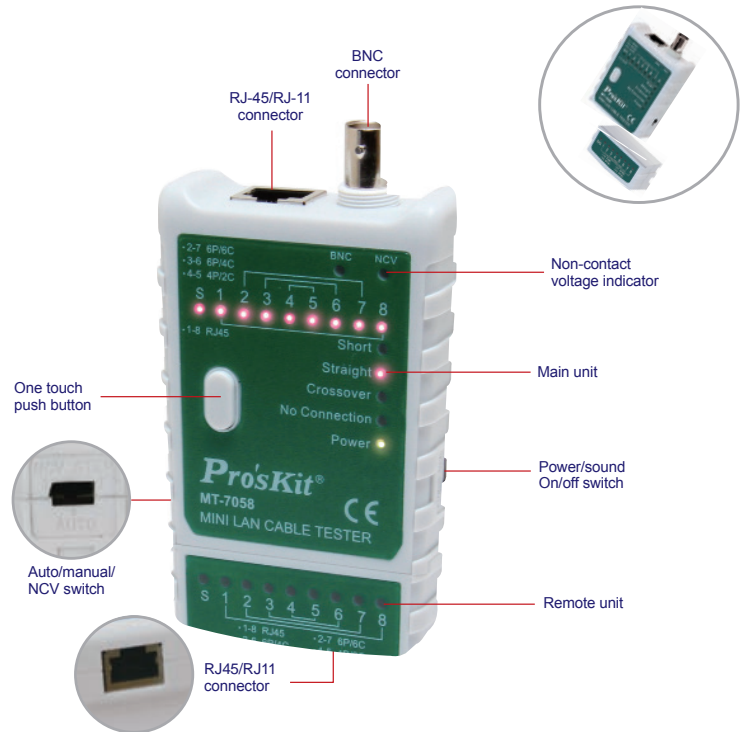

MT-7057N Cable Sniffer-Remote

CE  **RoHS COMPLIANT**   For testing RJ45/RJ11/RJ12/BNC/USB tester

Features:

- Simple one push-button operation.
- Power supplied by a 9V battery (Not included).
- Palm size design, easy to carry around.
- Detects open, short, miswired and cross-connected wire.
- Four types of connectors provided to test RJ45, RJ11, USB and BNC.
- Measuring distance: 500m.

Individual packing: Color box



RJ45 Lan cable test



RJ11/12 telephone wire test



USB cable test



BNC coaxial cable test



Accessories: Pouch bag and BNC to RJ45 connector



▶ 400-001 LAN Cable Tester With Remote



For testing RJ45/BNC cable

Features:

- Multi-network cable tester is specified to quickly test by auto scanning wires continuity, mis-wiring and polarity in your network cables, thin Ethernet (BNC)/10 Base-T (UTP/STP)/356A/TIA-568A/TIA-568B/Token Ring. By using the attached remote terminator, you can easily test the cables before or after the cables are installed. It also allows you to test the ground of shielded twisted pairs cables.

Individual packing: Blister card

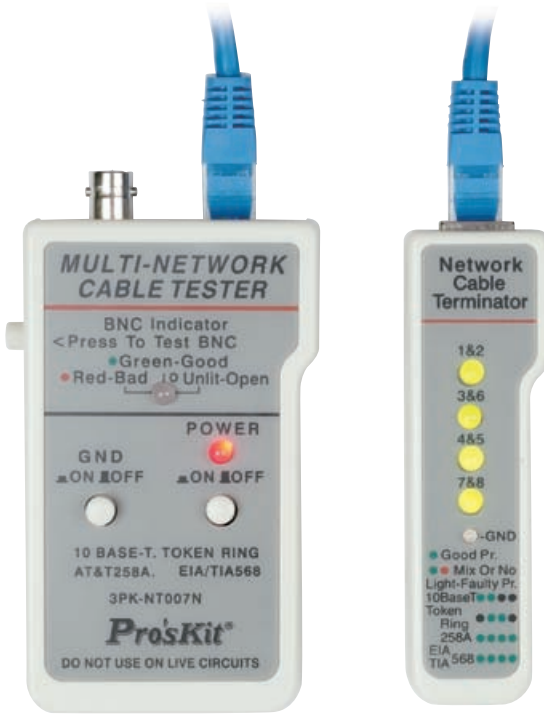

For BNC, RJ-45 twisted pair test



Accessories:Pouch bag and BNC connector

▶ 400-004 Multi-Modular Cable Tester



For testing RJ45/RJ11/RJ12 cable

Features:

- Multi-modular cable tester is specified to quickly test by auto scanning most of modular cables, USOC 4 / USOC 6 / USOC 8 terminating with RJ 45, RJ12, and RJ11 modular plug, wires continuity and mis-wiring. It can also be used for testing if the cable is crossed pinning or straight through. Moreover, with the remote terminator, it can be further used in remote testing even when the cable has already been installed.

Individual packing: Blister card

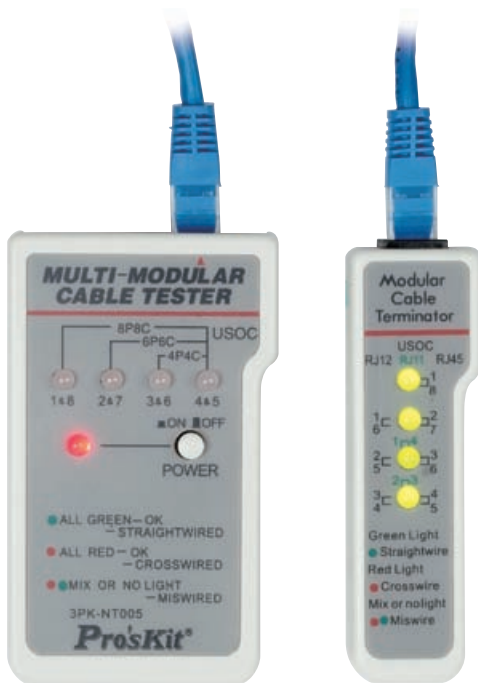

Accessories:Pouch bag

Pro'sKit® Test Instruments

Maximum display range and accuracy for digital multimeters and digital clamp meters and environmental meters

rdg(reading)
The value on the digital display, readout.



dgt(digit)
Indicates the least significant digit.
It represents the error used for processing fractions when converting from analog to digital.

Maximum display range

MT-1860/1820: the maximum display range is "5999".
MT-1232: the maximum display range is "3999".
MT-1280/1270/1210: the maximum display range is "1999".
For example of measuring resistance at MT-1232

Resistance	Display	
4000k	4.000M	The range is automatically switched so that the display unit is M or k
4000	4.000k	
40	40.00	The reading is display with three digits.

Accuracy

When ACV measurement using the MT-1270, the maximum display value is 199.9V, minimum display value is 0.01V.



Example

The accuracy of the AC200 V reading is $\pm(0.8\%rdg+5dgt)$.
when measuring AC100V, the accuracy reading display range is 100.9-99.15.
 $100V \pm (0.8\% + 5dpt)$
 $= 100 + (0.80 + 0.05) - 100 - (0.80 + 0.05)$
 $= 100.9 - 99.15$

SI prefixes

Symbol	Prefixes	Decimal		Units frequently used
		Long Scale	Short Scale	
G	giga	1X1,000,000,00	1X10 ⁹	GHz
M	mega	1X1,000,000	1X10 ⁶	M , MHz
K	kilo	1X1,000	1X10 ³	k , kV, kW,kHz
m	milli	1/1,000	1X10 ⁻³	mV, mA, mW, mF, mH
μ	micro	1/1,000,000	1X10 ⁻⁶	μV, μA, μW, μF, μH
n	nano	1/1,000,000,000	1X10 ⁻⁹	nA, nF, nH
p	pico	1/1,000,000,000,000	1X10 ⁻¹²	pF, pH

USB USB connector



V DC voltage

V AC voltage

A DC current

A AC current

Ω Resistance

Hz Frequency

+ Capacitance

⊞ Inductor check

°C/°F Temperature °C/°F measurement

°C Temperature °C measurement

Hz Duty Duty cycle

REL Relative reference

••• Continuity buzzer

CONT. LED Continuity check

▶ Diode test

hFE Transistor hFE test

LED LED test

🔋 Battery check



Backlight



Maximum/Minimum value



Maximum value hold



Data hold



Auto power off



Low battery



Zero-ohm adjuster



Output terminal

Most of Pro'sKit® test instruments are approved by CE EN61010-1 CATII/ CATIII test .

CAT. II Primary circuits or equipments connected to low voltage facilities, such as a standard wall outlet.

CAT. III Equipment used for measurement in building facilities, distribution boards, and circuit breakers.



Hygrometer



Thermometer



Light meter



Sound level meter

▶ MT-1860 Professional Digital Multimeter



- Features:**
- 3 5/6 digits 5999 counts.
 - 0.5% best accuracy.
 - Auto range.
 - USB connector for PC.
 - Dual display with analog bar-graph.
 - Touch keys.
 - Extra functions: duty cycle, relative reference, backlight, Max/Min hold, data hold, auto power off, low battery indication.



mini USB connector



Accessories

Mini USB connector to computer



Specification	
DCV	600m/6/60/600V ±(0.5%+4d), 1000V ±(1.0%+4d)
ACV	6/60/600V ±(0.8%+10d), 750V ±(1.0%+6d)
DCA	60m/600mA ±(1.0%+10d), 6/10A ±(1.2%+10d)
ACA	60m/600mA ±(1.5%+10d), 6/10A ±(2.5%+15d)
Resistance	600Ω ±(0.8%+5d), 6k/60k/600k/6MΩ ±(0.8%+4d), 60MΩ ±(1.2%+10d)
Frequency	10/100/1000/10k/100k/1M/20MHz ±(0.3%+2d)
Capacitance	40nF ±(5%+30d), 400n/4μ/40μF ±(3.5%+8d), 200μF±(5.0%+10d)
Temperature	-20~400°C(0~750°F) ±(1.0%+5d), 400~1000°C(750~1832°F) ±(1.5%+15d)
Power source	AAA(1.5V)x2pcs (Not Included)
Continuity with beeper	Y
Diode test	Y
Size	185×91×49 mm / 7.3"×3.6"×1.9"
Individual Packing	Color box

▶ MT-1710 True-RMS Auto Range Multimeter

AC True-RMS



- Features:**
- 3 3/4 digits 3999 counts.
 - 0.5% best accuracy.
 - Both Auto and Manual range.
 - AC True-RMS for accurate measurements.
 - Extra functions: Continuity with beeper, Diode test, Transistor test, Duty cycle, Relative reference, Data hold, Auto power off, Low battery indication, Input alert, LCD backlight.
 - Ideal for a wide variety of electrical and electronic testing applications.



Transistor hFE test



Specification	
DC Voltage (V)	400m/4/40/400V ±(0.5%+4d), 1000V ±(1.0%+6d)
AC Voltage (V) True-RMS	40~1kHz(sine and triangular wave) and 40~200Hz(other wave): 400mV ±(1.6%+8d), 4/40/400/750V ±(1.0%+10d) 200~1kHz(other wave): 400m/4/40/400/750V ±(8.0%+15d)
DC Current (A)	400u/4000uA ±(1.0%+10d), 40m/400mA ±(1.2%+8d), 10A ±(1.2%+10d)
AC Current (A) True-RMS	40~1kHz(sine and triangular wave) and 40~200Hz(other wave): 400u/4000u/40m/400mA ±(1.5%+10d), 10A ±(2.0%+15d) 200~1kHz(other wave): 400u/4000u/40m/400mA ±(8.0%+15d)
Resistance (Ω)	400Ω ±(0.8%+5d), 4k/40k/400k/4MΩ ±(0.8%+4d), 40MΩ ±(1.2%+10d)
Frequency (Hz)	100/1000/10k/100kHz ±(0.5%+10d), 1M/30MHz ±(0.5%+10d)
Capacitance (F)	10n ±(5.0%+20d), 100n/1u/10u/100uF ±(3.5%+8d), 1/10/100mF ±(5.0%+10d)
Temperature (°C/°F)	-20~400°C(-4~752°F) ±(1.0%+5d), 400~1000°C(752~1832°F) ±(1.5%+15d)
Power source	9V (NEDA 1640/6F22) battery
Size	190×95×45 mm / 7.4"×3.7"×1.76"
Individual Packing	Color box

▶ MT-1705 3 1/2 True-RMS Multimeter

AC True-RMS



- Features:**
- 3 1/2 digits 1999 counts.
 - 0.5% best accuracy.
 - Auto polarity indication.
 - AC True-RMS for accurate measurements.
 - Large backlight LCD display for easy reading.
 - Extra Function: Continuity with beeper, Diode test, Data hold, Auto power off, Low battery indication, Overload indication, LCD backlight
 - Frequency and Capacitance are auto range
 - Ideal for wide variety of electrical and electronic testing applications.



Specification	
DC Voltage (V)	200mV/2V/20V/200V±(0.5%+3d), 600V±(1.0%+10d)
AC Voltage (V) True-RMS	40Hz-200Hz and 200Hz-1KHz Sine and triangular wave, 2V/200V±(0.8%+5d), 600V±(1.2%+10d) 200Hz-1KHz otherwave, 2V/200V/600V±(8.0%+15d)
DC Current (A)	20mA/200mA±(1.2%+8d), 10A±(2.0%+5d)
AC Current (A) True-RMS	40Hz-200Hz and 200Hz-1kHZ Sine and triangular wave, 200mA±(1.5%+15d), 10A±(3.0%+10d) 200Hz-1kHZ Other wave, 200mA/10A±(8.0%+15d)
Resistance (Ω)	200±(0.8%+5d), 20K/200K±(0.8%+3d), 20M±(1.0%+25d)
Frequency (Hz)	10/100/1k/10k/100k/2M Hz±(1.0%+10d)
Capacitance (F)	20nF/200nF/2uF±(3.5%+20d), 20uF/200uF/2000uF±(5.0%+10d)
Power source	3V(1.5VAAA*2)
Size	150×73.5×35 mm / 5.9"×2.89"×1.18"
Individual Packing	Color box

▶ MT-5211 3 1/2 Digital LCR Multimeter

Fully featured with LCR & DMM Multimeter



Specification	
DC Voltage (V)	200mV/2V/20V/200V±(0.5%+3d), 1000V±(1.0%+5d)
AC Voltage (V)	200mV±(1.2%+3d), 2V/20V/200V±(0.8%+5d), 750V±(1.2%+5d)
DC Current (A)	2mA/20mA±(0.8%+3d), 200mA±(1.2%+4d), 20A±(2.0%+5d)
AC Current (A)	2mA/20mA±(1.0%+5d), 200mA±(2.0%+5d), 20A±(3.0%+10d)
Resistance (Ω)	200±(0.8%+5d), 2K/20K/200K/2MΩ±(0.8%+3d),
Capacitance (uF)	20MΩ±(1.0%+15d), 2000MΩ±(5.0%(reading-10)+20d)
Inductance (L)	20nF/200nF/2uF±(2.5%+20d), 20uF/200uF±(5.0%+5d)
Temperature (T)	2mH/20mH/200mH/2H/20Hz±(2.5%+20d)
(-20~1000°C)	<400°C±(1.0%+4d), ≥ 400°C±(1.5%+15d)
Frequency (Hz)	2k/20k/200k/2000K/10M Hz±(1.0%+10d)
Power source	9V 6F22 battery (not included)
Weight	390g (not including battery)
Dimension(D×W×H) (mm/inch)	189×97.5×35mm / 7.4×3.8×1.3"
Accessories	Test lead, thermocouple, test socket
Individual packing	Color box



- Features:**
- 3 1/2 digits 1999 counts.
 - Dual slope A/D conversion.
 - Large backlight LCD display.
 - Extra functions: Continuity with beeper, Diode test, Data hold, Auto power off, Low battery indication, Overload indication, Backlight, Transistor Tester.
 - Ideal for a wide variety of electrical and electronic testing applications.



Transistor hFE test



Transistor hFE test



Accessories



▶ MT-5110 3 1/2 Capacitance Meter

Capacitance Measurement 0.1pF~20,000uF.



Specification	
Capacitance	200pF ±(0.5%+7d), 2n/20n/200n/2u/20u/200uF ±(0.5%+5d), 2,000uF ±(2.0%+5d), 20,000uF ±(3.0%+10d)
Zero adjustment	Manual (range±20pF)
Over-input	Display shows "1"
Input overload protections	Y
Sampling time	0~5 second
EN61010-1	CE
Power source	NEDA1604/6F22 (9V) x 1pcs (Not included)
Size (HXWXD)mm	182x90x46mm/7.2"x3.5"x1.8"
Test Lead model no.	MT-9906
Individual packing	Color box



- Features:**
- 3 1/2 digits 1999 counts.
 - Complies with the newest CE safety standard
 - High measuring accuracy: ±0.5%.
 - Measurements are possible even under a strong magnetic field.
 - LCD display with big digit for clear readout even in bright ambient.
 - Zero knob: Knob to zero when testing low capacitance.
 - Extra function: LCD backlight, low battery indication.



Capacitance test socket



Test probes, alligator clips



▶ MT-1217 3 3/4 Auto Range Digital Multimeter

Auto Range/Frequency/Capacitance/Temperature/DMM All in 1



Specification	
DCV	400mV/4V/40V/400V ±(0.5%+4d), 1000V ±(1.0%+6d)
ACV	4V/40V/400V ±(0.8%+6d), 750V ±(1.0%+10d)
DCA	400uA/4000uA ±(1.0%+10d), 40mA/400mA ±(1.0%+10d), 4A/10A±(1.2%+10d)
ACA	400uA/4000uA ±(1.5%+10d), 40mA/400mA ±(1.5%+10d), 4A±(2.0%+15d); 10 A±(2.5%+15d)
Resistance	400Ω ±(0.8%+5d), 4k/40k/400KΩ/4MΩ±(0.8%+4d), 40MΩ ±(1.2%+10d)
Frequency	400/4K/20KHz ±(0.5%+10d)
Capacitance	40nF ±(0.5%+30d), 400nF/4uF/20uF ±(3.5%+8d)
Temperature	(-20°C~1000°C) < 400°C±(1.0%+5d) (-20°C~1000°C) ≥ 400°C±(1.5%+15d)
Duty Cycle	0.1%~99.9%
Continuity with beeper	Y
Diode Test	Y
Transistor hFE test	Y (with socket)
Fuse	0.4A/250V Resetttable fuse, 10A/250V Fuse
Power source	9V*1(not included)
Size (HXWXD)mm/inch	182×90×46/7.2×3.5×1.8"
Test leads model no.	MT-9906
Individual packing	Color Box



- Features:**
- Complies with newest CE safety standard
 - 3 3/4 digits 3999 counts
 - Large and easy to read display panel
 - Overload and resettable fuse protection circuit design
 - Extra function: Auto range, relative reference, backlight, data hold, auto power off, low battery indication



transistor test socket, thermocouple probe



CAT III 1000V test lead



▶ MT-1280 Professional Digital Multimeter

CE CAT III 1000V



- Features:
- 3 1/2 digits 1999 counts
 - 0.5% best accuracy
 - Resettable fuse protection
 - Complies with the newest CE safety standard
 - Extra functions: Auto power off, low battery indication, LCD backlight, data hold, LED indicator

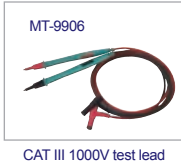

Capacitance/Temperature



Specification	
DC Voltage	200mV/2V/20V/200V ±(0.5%+3d), 1000V ±(0.8%+10d)
AC Voltage	2V/20V/200V ±(0.8%+5d), 750V ±(1.2%+10d)
DC Current	200µA/20mA ±(0.8%+10d), 200mA ±(1.2%+8d), 20A ±(2.0%+5d)
AC Current	20mA ±(1.0%+5d), 200mA ±(2.0%+5d), 20A ±(3.0%+10d)
Resistance	200Ω ±(0.8%+5d), 2K/20K/200KΩ ±(0.8%+3d), 20MΩ ±(1.0%+25d), 200MΩ ±(5.0%+10d)
Capacitance	20nF ±(2.5%+20d), 20µF ±(2.5%+20d), 200µF ±(5.0%+20d)
Temperature	-20°C~400°C±(1.0%+5d), 400°C~1000°C±(1.5%+15d)
Continuity with beeper	Y
Diode test	Y
Transistor test	Y
Battery	9V(6F22) (Not Included)
Size (HxWxD)mm	182x90x46/7.2"x3.5"x1.8"
Individual packing	Color box

▶ MT-1270 Digital Multimeter

CE CAT III 1000V



- Features:
- 3 1/2 digits 1999 counts
 - 0.5% best accuracy
 - Complies with the newest CE safety standard
 - Resettable fuse protection
 - Extra functions: data hold, auto power off, low battery indication, LCD backlight

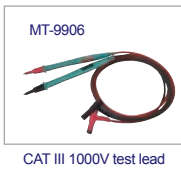

Frequency/Capacitance/Temperature/DMM All in 1



Specification	
DC Voltage	200mV/2V/20V/200V ±(0.5%+3d), 1000V ±(0.8%+10d)
AC Voltage	2V/20V/200V ±(0.8%+5d), 750V ±(1.2%+10d)
DC Current	2mA/20mA ±(0.8%+10d), 200mA ±(1.2%+8d), 10A ±(2.0%+5d)
AC Current	20mA ±(1.0%+15d), 200mA ±(2.0%+5d), 10A ±(3.0%+10d)
Resistance	200Ω ±(0.8%+5d) 2K/20K/200K/2MΩ ±(0.8%+3d) 20MΩ ±(1.0%+25d) 200MΩ ±(5%+reading-10)+30d]
Frequency	20K Hz ±(1.5%+4d)
Capacitance	2nF ±(4.0%+20d), 20nF ±(4.0%+20d), 200nF ±(4.0%+20d), 2µF ±(4.0%+20d), 20µF ±(5.0%+30d)
Temperature	(-20°C~1000°C)±(2.0%+2d)
Diode Test	Y
Transistor Test	Y
Continuity with beeper	Y
Battery	9V(6F22) (Not Included)
Size (HXWXD)mm	182x90x46/7.2"x3.5"x1.8"
Test Lead model no.	MT-9906
Individual packing	Color box

▶ MT-1232 3 3/4 Autorange Digital Multimeter

CE CAT III 600V



- Features:
- 3 3/4 digits 3999 counts
 - Complies with the newest CE safety standard
 - Overload and mis-use protection
 - Resettable fuse protection
 - Extra functions: Relative reference, backlight, data hold, auto power off, low battery indication.



Auto range/Frequency/Capacitance/Temperature/DMM All in 1



Specification	
DC Voltage	400mV/4V/40V/400V ±(0.5%+4d), 600V ±(1.0%+4d)
AC Voltage	4V/40V/400V ±(0.8%+6d), 600V ±(1.0%+6d)
DC Current	400µ/4,000µA ±(1.0%+10d), 40mA/400mA ±(1.0%+10d), 10A ±(1.2%+10d)
AC Current	400µ/4,000µA ±(1.5%+10d), 40mA/400mA ±(1.5%+10d), 10A ±(2.5%+15d)
Resistance	400Ω ±(0.8%+5d), 4k/40k/400k/4MΩ ±(0.8%+4d), 40MΩ ±(1.2%+10d)
Frequency	1/10/100Hz ±(0.5%+10d), 1K/10K/100KHz ±(0.5%+10d), 1/10MHz ±(0.5%+10d)
Capacitance	4nF ±(0.5%+9d), 40nF/400nF/4µF/40µF ±(3.5%+8d), 100µF ±(5.0%+8d)
Temperature	(-20C~1000C) < 400C±(1.0+5d), (-20C~1000C) >= 400C±(1.5+15d)
Duty Cycle	0.1% ~ 99.9%
Continuity with beeper	Y
Diode test	Y
Fuse	10A/250V
Power source	1.5V AA x 2 (not included)
Size	147x78x41mm/5.8"x3.1"x1.6"
Test leads model no.	MT-9907
Individual packing	Color box

▶ MT-1132 3 1/2 Digital Multimeter

LCD backlight/Data hold



Specification	
DC Voltage	200mV/2V/20V/200V ±(0.5%+2d), 500V ±(0.8%+5d)
AC Voltage	200V ±(1.2%+10d), 500V ±(1.2%+10d)
DC Current	200µA/2mA/20mA/200mA ±(1.0%+5d), 10A ±(2.5%+5d)
Resistance	200Ω ±(0.8%+5d), 2K/20K/200K ±(0.8%+5d), 2MΩ ±(1.0%+5d)
Continuity with beeper	Y
Diode Test	Y
Transistor hFE test	Y
LED test	Y
Battery check	Y (1.5V)
Fuse	10A/250V
Power source	1.5V AA x 2 (not included)
Size	147x78x41mm/5.8"x3.1"x1.6"
Test leads model no.	MT-9907
Individual packing	Color box

Features:

- 3 1/2 digits 1999 counts
- Complies with the newest CE safety standard
- Large and easy to read display panel
- Overload and mis-use protection
- Extra functions: backlight, data hold, low battery indication.
- User friendly interface is ideal for students, DIY market, home applications and more



Test lead, thermocouple probe

CE CAT III 600V P6



▶ MT-1210 3 1/2 Digital Multimeter

With backlight, data hold, economic type.



Features:

- 3 1/2 digits 1999 counts.
- 1% best accuracy.
- Extra functions: backlight, data hold, low battery indication.

Specification	
DCV	200mV/2V/20V/200V ±(1.0%+2d), 500V ±(1.2%+5d)
ACV	200/500V ±(2.5%+10d)
DCA	200µ/2m/20m/200mA ±(2.0%+5d), 10A ±(3.0%+5d)
Resistance	200Ω/2k/20k/200kΩ ±(1.0%+5d), 2MΩ ±(1.5%+5d)
Continuity with beeper	Y
Diode test	Y
Transistor hFE test	Y
Power source	NEDA1604/6F22 (9V) x 1pcs(Not included)
Size	144x70x32 mm / 5.7"x2.8"x1.3"
Individual package	Double blister



Transistor hFE test



Back light

CE CAT II 600V P6



▶ MT-1508 Pocket Autorange Multimeter

Non-Contact ACV Detector, LCD Backlight, Data Hold, Auto Power Off, Auto Range



- Comes with a backlight, 3 1/2 digits 1999 counts easy for reading.
- Auto range functions provide accuracy, easy to use.
- Extra function: Auto power off, low battery indication, Data hold, Over range indication.
- Pocket size design for easy carrying.
- Non contact ACV detector and built-in LED flash light.

Specification	
DC Voltage (V)	200mV/2V/20V/200V±(0.5%+3d) 600V±(0.8%+5d)
AC Voltage (V)	2V/20V/200V±(0.8%+3d)600V±(1.0%+5d)
DC Current (A)	200µA/2000µA /20mA/200mA±(1.8%+5d)
AC Current (A)	200µA/2000µA /20mA/200mA±(2.0%+5d)
Resistance (Ω)	200Ω/2kΩ/20kΩ/200kΩ/2MΩ±(1.0%+3d) 20MΩ±(1.2%+15d)
Functions	Non contact ACV detector, Diode test, Continuity with beep
Power source	2x1.5V AAA battery (not included)
Weight	152g (not including battery)
Dimension(D×W×H) (mm/inch)	125x60x26mm / 4.9x2.4x1.0"
Individual packing	Blister card

RoHS COMPLIANT CE CAT III 600V



▶ MT-1233C 3 1/2 Digital Multimeter

CE CAT II 300V



Accessories:
Test leads, thermocouple probe

LCD backlight, Data hold, °C and °F temperature test, Palm Size.



Features:

- Complies with the newest CE safety standard
- 3 1/2 digits 1999 counts
- Palm size for easy storage and carrying
- Extra functions: backlight, data hold, low battery indication, overload protection indication
- User friendly interface is ideal for students, DIY market. home applications and more

Specification	
DCV	200m/2000m/20/200V ±(0.8%+3d), 500V ±(1.0%+3d)
ACV	200/500V ±(1.2%+5d)
DCA	2000u/20m/200mA ±(1.2%+5d), 10A ±(2.5%+5d)
Resistance	200Ω ±(1.5%+5d), 2000/20k/200kΩ ±(1.0%+3d), 20MΩ ±(1.0%+5 d)
Temperature	-40~150°C ±(1.0%+3d), 150-1000°C ±(1.5%+15d), -40~302°F ±(1.0%+4d), 302-1832°F ±(1.5%+15d)
Continuity with beeper	Y Diode test Y
Power source	1.5V AAA x 2 (not included)
Size	130 x 72 x 28mm / 5.1"x2.8"x1.1"
Individual packing	Double blister

▶ MT-1233D 3 1/2 Digital Multimeter

CE CAT II 300V



Accessories: Test leads

LCD backlight, Data hold, High resistance test, Square signal output, Palm Size.



Features:

- Complies with the newest CE safety standard
- 3 1/2 digits 1999 counts
- Palm size for easy storage and carrying
- Extra functions: backlight, data hold, low battery indication, overload protection indication
- User friendly interface is ideal for students, DIY market. home applications and more

Specification	
DCV	200m/2000m/20/200V ±(0.8%+3d), 500V ±(1.0%+3d)
ACV	200/500V ±(1.2%+5d)
DCA	2000u/20m/200mA ±(1.2%+5d), 10A ±(2.5%+5d)
Resistance	200Ω ±(1.5%+5d), 2000/20k/200kΩ ±(1.0%+3d) 20MΩ ±(1.0%+5d), 200MΩ ±(1.0%+10d)
Square signal output	50Hz (5 Vp-p, 50KΩ)
Continuity with beeper	Y Diode Test Y
Power source	1.5V AAA x 2 (not included)
Size	130 x 72 x 28mm / 5.1"x2.8"x1.1"
Individual packing	Double blister

▶ MT-1630 3 1/2 Pen-Style Meter

CE



Pen Type, Compact Size DMM



Features:

- 3 1/2 digits 1999 counts.
- 0.8% best accuracy.
- Auto range.
- Compact in size, light in weight and simple to use.
- Penlight brightly illuminates the point to be measured, even in dark places.
- Unique protection mechanism for the test probe for safety.
- Extra functions: auto power off, data hold, low battery indication.

Specification	
DCV	200m/2/20/200/600V ±(0.8%+5d)
ACV	2/20/200V ±(1.0%+3d), 600V ±(1.2%+3d)
DCA	20m/200mA ±(1.5%+10d)
ACA	20m/200mA ±(3.0%+10d)
Resistance	200Ω ±(1.0%+5d), 2k/20k/200k/2MΩ ±(1.0+3d), 20MΩ ±(1.2%+5d)
Continuity with beeper	Y
Diode test	Y
Over range indication	Y
Sampling rate	Approximately 3 times per sec.
Fuse protection	Y
Power source	LR44(1.5V)x2 pcs
Size	205 x 35 x 30 mm / 8.1"x1.4"x1.2"
Individual packing	Double blister

MT-3109 AC/DC Digital Clamp Multimeter

AC/DC current, Frequency, Capacitance measurement.



AC / DC Measurement

CE CAT II 600V P6

Specification	
DCV	400m/4V ±(1.0%+3d), 40/400V ±(1.0%+1d), 600V ±(1.0%+5d)
ACV	4/40/400V ±(1.2%+5d), 600V ±(1.5%+5d)
DCA	40A ±(2.5%+5d), 400A ±(2.5%+3d)
ACA	40A ±(3.0%+8d), 400A ±(3.0%+5d)
Resistance	400Ω ±(1.2%+5d), 4k/40k/400kΩ ±(1.0%+5d), 4MΩ ±(1.2%+5d), 40MΩ ±(1.5%+5d)
Frequency	10/100/1k/10k/100k/1MHz ±(0.1%+5d), 10MHz (For reference only)
Capacitance	40n/400n/4μ/40μF ±(5.0%+10d), 100μF ±(6.0%+10d)
Diode test	Y
Continuity with Buzzer	Y
Power Source	AAA(1.5V) x 3 pcs (Not included)
Size	203 x 68 x 33 mm / 8.0"x2.7"x1.3"
Individual Packing	Double Blister

Features:

- 3 3/4 digits 3999 counts
- 1.0% best accuracy.
- Auto range.
- Overload protection.
- Extra function: duty cycle, relative reference, data hold, sleep mode, auto power off, low battery indication.
- Jaw Opening Size: max. 30mm



ACA measurement



DCA measurement

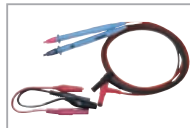

Accessory



MT-3102 3 1/2 2A Mini Digital Clamp Meter

AC current 2A, Temperature measurement.



CE CAT II 600V P6

Specification	
DCV	200mV ±(0.8%+5d), 2/20/200V ±(0.8%+3d), 600V ±(1.0%+5d)
ACV	2/20/200V ±(1.2%+5d), 600V ±(1.5%+5d)
ACA	2A ±(3.0%+15d) ≤ 0.4A ±(4.0%+20d), 20A ±(2.0%+10d) ≤ 0.4A ±(3.0%+15d), 200/400A ± (2.0%+5d)
Resistance	200Ω ±(1.2%+5d), 2k/20k/200kΩ ±(1.0%+3d), 2MΩ ±(1.2%+5d), 20MΩ ±(1.5%+5d)
Temperature °C/ °F	-40~0 °C ±(3.0%+4d), 0~400 °C ±(1.0%+3d), 400~1000 °C ±(2.0%+10d) -40~32 °F ±(3.0%+8d), 32~752 °F ±(1.0%+6d), 752~1832 °F ±(2.0%+18d)
Diode test	Y
Continuity with beeper	Y
Power source	AAA(1.5V) x 3 pcs (Not included)
Size	203 x 68 x 33 mm / 8.0"x2.7"x1.3"
Individual packing	Double blister

Features:

- 3 1/2 digits 1999 counts.
- 0.8% best accuracy.
- Auto range.
- Portable and simple one-hand operation.
- Extra function: Maximum value hold, data hold, auto power off, low battery indication.
- Max. jaw opening: max. 30mm.



Accessory



ACA measurement



MT-3266 3 1/2 Hand Held Digital Clamp Meter



CE CAT II DC 1000V AC 750V P6

Features:

- 3 1/2 digits 1999 counts.
- 0.8% best accuracy.
- Portable and simple one-hand operation.
- Extra function: data hold, low battery indication.
- Max. jaw opening: max. 50mm.
- Comes with zippered pouch.

Specification	
DCV	1,000V ±(0.8%+2d)
ACV	750V ±(1.2%+4d)
ACA	200/1,000A ±(3.0%+5d)
Resistance	200Ω ±(1.0%+3d), 20kΩ ±(1.0%+1d)
Continuity with beeper	Y
Power Source	NEDA1604/6F22 (9V) x 1pcs(Not included)
Size	230 x 70 x 37 mm / 9.1"x2.8"x1.5"
Individual package	Double blister



Accessory



ACA measurement



▶ **MT-2017** Protective Function Analog Multimeter

CE **CAT II 1000V** **CAT III 500V** 



Gilded test leads
Attached 1000V 10A gilded test lead, more stable and reliable



Overload Protection, Gilded test leads, Null DCV



- Comes with foldable stand and hook-up design for convenient use.
- Separately 9V and 1.5V batteries cases, replace battery or fuse more easily.
- Overload protection with two fuses 0.5A & 10A ensures uninterrupted operation and long lifetime.
- Attached 1000V 10A gilded test leads, more stable and reliable.

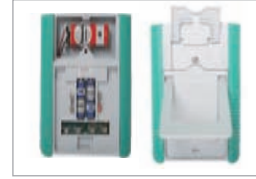

New Mechanism Design

Separately 9V and 1.5V batteries cases, replace battery or fuse more easy. Foldable stand and hook-up design.

Specification	
DCV	0.1/2.5/10/50/250V ±3.0%FSD, 1000V ±4.0%FSD
Null DCV	DC ± 5V / ±25V ±5.0%FSD
ACV	10/50/250V ±4.0%FSD, 1000V±5.0%FSD
DCA	50μ/2.5m/25m/250mA ±3.0%FSD, 10A ±4.0%FSD
Resistance	×1(0.2~2kΩ) / ×10(2~20kΩ) / ×100(20~200kΩ) / ×1k(200~2MΩ) / ×10kΩ(2k~20MΩ) ±4.0%ARC of scale length
Capacitance	C(R×1k): 2000μF(Approx.) Max
Battery check	1.5V/9V
Transistor hFE test	Y
Diode & LED test	Y
Continuity with beeper	Y
Front Panel Controls	Range selector switch with "OFF" position, 0Ω adjust knob
Power source	1.5V AAA x 2pcs and 9V(NEDA1604) x 1pcs
Size(mm/inch)	171x108x37/6.7x4.3x1.5"
Individual packing	Color box

▶ **MT-2018** Protective Function Analog Multimeter

CE **CAT II 1000V** 



With capacitance measurement



- Overload and mis-used protection via two fuses, oxide varactor & diodes.
- Robust protective holster alongside.
- 20kΩ/V DC & 9 kΩ/V AC input sensitivity.
- Adjustable back tilt device with hook-up design.
- Ideal for using in the fields of lab, school, home applications.



Adjustable back tilt device with hook-up



Test lead



batteries & fuses

Specification	
DCV	0.1/0.5/2.5/10/50/250V ±3.0%FSD, 1000V ±4.0%FSD
ACV	10/50/250V ±4.0%FSD, 1000V±5.0%FSD
DCmA	50μA/2.5mA/25mA/250mA ±3.0%FSD
Resistance	×1(0.2~2kΩ) / ×10(2~20kΩ) / ×100(20~200kΩ) / ×1k(200~2MΩ) / ×10kΩ(2k~20MΩ) ±4.0%ARC
Capacitance	C1(R×1k): 2000μF(Approx.), C2(×50μA): 0.025μF/0.25μF/25μF ±3.0%FSD(Option MT-2007-C)
Battery Check	1.5V/9V
Transistor hFE test	Y
Diode & LED test	Y
Front Panel Controls	Range selector switch with "OFF" position, 0Ω adjust knob
Power Source	1.5V AA x 2pcs and 9V(NEDA1604) x 1pcs
Size(mm/inch)	160 x 105 x 40/6.3x4.1x1.6"
Individual Packing	Color box



NT-8540 / NT-8560 / NT-8580 Laser Distance Measurer



Multi-Measurements, Extra Side Key, Spray Proof, Dustproof

Ideal for measuring factory layout, facilities safety area, trench depth for solar installation, building maintenance, ceilings maintenance, road works, water level, sheet rock measurement.



Outdoor / Indoor Use

Comply with IP54 rated as dust-protection and spray-proof.

Extra Side Key

One touch extra side key for using easily and quickly.

Integrated Multi-measuring Functions

Area, volume, pythagorean measurement allows easy measuring in many different applications.

LCD Display

Comes with large LCD display with backlight allows for data reading in dark areas.

Fold-out Extension

Extension allows offset reference point for convenience.

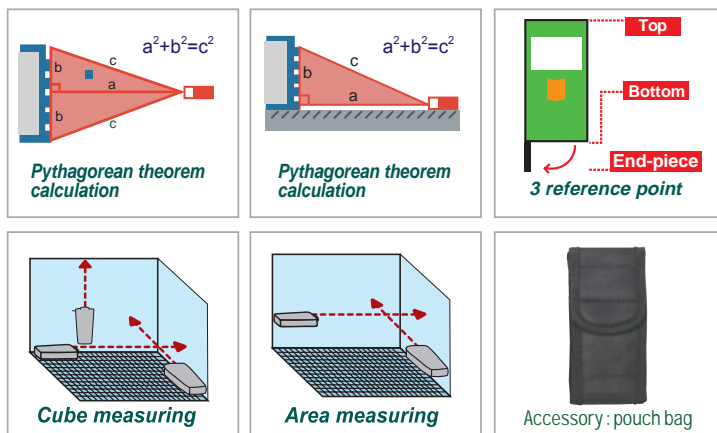

Model No.	NT-8540	NT-8560	NT-8580
Measuring range	0.2-40M	0.2-60M	0.2-80M
Measuring accuracy	±1.5mm		
LCD display	4-line display with backlight		
Measuring functions	Length / Area / Volume		
Continuous measurement	Yes		
Min, Mix measurement	Yes		
Pythagorean 1	Yes		
Pythagorean 2	Yes		
Add/Subtraction	Yes		
Data memory	20 record		
Unit selection	M / ft / in / ft+in		
Beep indication	Yes		
Auto power off	After 3min.		
Auto laser power off	30s		
Low battery indicate	Y		
Laser class	Class 2M		
Laser power	635 nm≤1mW		
Operation temperature	0°C-40°C		
Storage temperature	-10°C-60°C		
Power source	2 x 1.5V AAA batteries(not included)		
Weight	113g (not including battery)		
Dimension(LxWxD) (mm/inch)	115 x 52 x 32.5mm / 4.5x 2.0 x 1.3"		
Individual packing	Color Box		

▶ MT-4616 Temperature / Humidity / Dew Point Meter



- Tests ambient temperature, relative humidity, wet bulb, dew point temperature.
- Data memory up to 99 memories.
- Unit °F/°C selection, high precision & portable for measuring.
- Extra functions: Max./Min. value, low battery indication, auto power off, backlight, data hold.

99 Data Memories, 3 Types of Temperatures



Specification	
Temperature Range	-20~60°C(-4°F~140°F)
Temperature Accuracy	±1°C(0~45°C), ±1.5°C(-20~0°C, 45~60°C)
Humidity Range	0~100%RH
Humidity Accuracy	±3%(20%~80%), ±4%(0~20%, 80%~100%)
Wet Bulb Temperature Range	-20~60°C(-4~140°F)
Wet Bulb Temperature Accuracy	±1°C(0~45°C), ±1.5°C(-20~0°C, 45~60°C)
Dew Point Range	-50~60°C(-58~140°F)
Dew Point Accuracy	±1°C(0~45°C), ±1.5°C(-50~0°C, 45~60°C)
Resolution	0.1C/F ; 0.1%
Data Memory	Max. 99 of data
Unit selection	°C / °F
Auto power off	After 30mins, on/off selection
Power source	AAA 1.5V x 4 (not included)
Weight	114g (not including battery)
Dimension (L×W×D) (mm/inch)	184 x 60 x 29mm / 7.2 x 2.4 x 1.1"
Accessory	Storage Bag
Individual Packing	Double blister

▶ MT-4617 Light Intensity Meter



- Measures the visible light produced by fluorescent lamp, metal-halide lamp, high voltage sodium lamp or electric incandescent lamp.
- Built-in precision photo diode sensor and color correction filter.
- Automatic and manual measured range switching.
- Relative and peak value measurement.
- Measures up to 200,000 lux / 20,000 FC.
- Extra functions: Max./Min. value, over load indication/low battery indication, auto power off, data hold, zero calibration.

Auto/Manual Range, Zero Calibration, Relative & Peak Value



Specification	
Range	20, 200, 2000, 20000, 200000 Lux, 20, 200, 2000, 20000 FC
Ring spectral range	320~730nm
Accuracy	±3% (When at 2854K calibrated in accordance with the ordinary incandescent) ±6% (when at other visible light source)
Unit	Lux., FC
Sensor	Silicon photodiode
Sampling time	≥2 times/sec.
Auto power off	After 10 min.
Operation sound	on/off Selection
Low battery indicate	<7V
Operation environment	0~85%RH, -10, 50°C (no condense)
Storage environment	0~70%RH, -10, 50°C (no condense)
Operating altitude	Max. 2000m
Power source	9V (not included)
Weight	154 g (not including battery)
Dimension(L×W×D) (mm/inch)	170 x 85 x 45mm / 6.7 x 3.3 x 1.8"
Accessory	Storage bag
Individual packing	Double blister

▶ MT-4618 Sound Level Meter



- A & C weighting network selection
- Measuring range from 30 to 130 dB
- LCD display with backlight
- High speed (FAST)/Low speed (SLOW) response rate selection
- Extra functions: Max./Min. value, data hold, auto range, backlight, good anti-interference performance, auto power off

Auto Range, Over Range Indication, Weighted Sound Pressure Frequency



Specification	
Range	30—130dB _A , 35—130dB _C , 30—80db, 40—90db, 50—100db, 60—110db, 70—120db, 80—130db, 30~130 db is auto range
Accuracy	±1.5dB (94dB@1KHz), ±5dB (94dB@8KHz)
Resolution	0.1dB
Response frequency	30Hz — 8KHz
Dynamic sound pressure	50 dB (at each range) FAST 125ms, SLOW 1sec
Frequency weighting	A and C type
Sensor	Polarized condenser microphone
Sampling time	2 times/sec., Analog 20 times/sec.
Operating environment	10~80%RH, 0°C~40°C (Non-condensing)
Storage environment	10~70%RH, -10°C~60°C (Non-condensing)
Low battery indication	<5V
Power source	1.5V AAA battery x 4 (not included)
Weight	174 g (not including battery)
Dimension(L×W×D) (mm/inch)	174 x 60 x 29mm / 6.9 x 2.4 x 1.1"
Accessory	Storage bag
Individual packing	Double blister

MT-4611 Combustible Gas Detector

Sound & Light Alarm, Quick-response Sensor

- Quickly identifies & pinpoints gas leaks, provides visible & audible alarm.
- Detection at 10% ~ 40% lower explosion limited.
- Adjustable sensitivity setting helps precisely locate leaks.
- Rugged ergonomic & easy-to-use design.
- 35cm flexible probe allows location and detection of leak in hard-to-reach and confined spaces.

Specification	
Sound and LED light alarm	Measuring distance 1 meter, beep about 65dB
Resolution	50 ppm (methane)
Test range	10%—40% LEL
Response time	< 2S (40% LEL)
Sensor	Catalytic combustion
Low battery indicate	<5V
Operation environment	10~90%RH, 0°C~50°C (no condense)
Storage environment	10~70%RH, -10°C~60°C (no condense)
Power source	1.5V / AA battery x 4 (not included)
Weight	290 g (not including battery)
Dimension (L×W×D)(mm/inch)	Meter, 200x75x50mm / 7.9 x 3.0 x 2.0", flexible probe, Ø8x350mm / Ø0.3 x 13.8"
Accessory	Storage bag
Individual packing	Double blister



MT-4612 Infrared Thermometer

Non-Contact Measurement, Fast Response,

- Dual laser for accurately aiming with fast (500 ms) response time
- Ergonomic design and rugged construction
- Extra functions: unit selection, backlight, auto power off, low battery indication, Data hold, Max./Min./average/difference record, high/low temperature alarm

Specification	
Temperature Range	-50°C~580°C(-58°F ~1076°F)
Accuracy	±2°C or ±2%°C
Distance Spot Ratio	16:1
Emissivity	0.1~1.0
Laser class	Class II, <1mW
Response time & Wavelength	500ms / 8-14µm
Repeatability	±1°C or ±1%°C
Resolution	0.1°C
Unit selection	°C / °F
Data memory	9 memories
Laser target point	Dual Laser / can be selected on / off
Storage temperature	-20~50°C(-4~122°F)
Operating temperature	0~50°C, 10~95%RH
Power source	6F22(9V) (not included)
Weight	204g (not including battery)
Dimension(L×W×D)(mm/inch)	175 x 130 x 45mm / 6.9 x 5.1 x 1.8"
Individual packing	Double blister

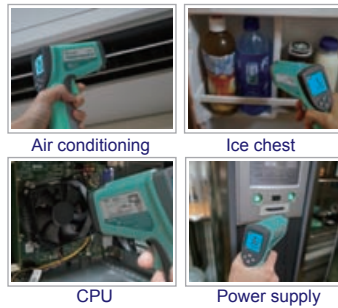
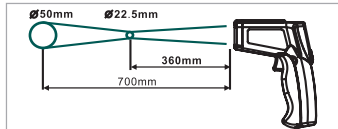

MT-4615 Anemometer

Air Velocity, Analog Bar Graphic, Variety of units, Air Volume, LCD Backlight, MAX./MIN Value



Specification	
Measuring range	0.8~40m/s
Accuracy	0.80~30.00 m/s, 1.40~108.00 km/h, 1.30~98.50 ft/s, 0.80~58.30 knots, 0.90~67.20 mi/h, 78~5900 ft/m, ±(2.0% + 50D), 30.00~40.00 m/s, 108.0~144.0 km/h, 98.50~131.20 ft/s, 58.30~77.70 knots, 67.20~90.00 mi/h, 5900~7874 ft/m,(only for reference)
Resolution	0.01m/s, 0.01km/h, 0.01 ft/s, 0.01knots, 0.01mile/h, 1ft/m
Unit	Air Velocity, m/s, km/h, mi/h, ft/m, ft/s, knots, Air Volume, CMS (m3/s), CMM m3/min, CFM (ft³/min), 30~40m/s only for reference
Sensor	Conventional arm angle to the impeller
Sampling time	0.4s
Auto power off	10 minutes (adjustable)
Low battery indication	<7V
Operation environment	0~85%RH, 0°C~40°C(no condense)
Fan Operation environment	0~95%RH, -20°C~80°C(no condense)
Storage environment	0~80%RH, -20°C~80°C(no condense)
Operating altitude	Max. 2000m
Power source	9V 6F22 (not included)
Weight	154 g (not including battery)
Dimension (L×W×D)(mm/inch)	170 x 85 x 40mm / 6.7 x 3.3 x 1.6"
Accessory	Storage bag
Individual Packing	Double blister

- Measuring air velocity and air volume.
- Large LCD backlight for easy reading even in dark area.
- Variety of units to choose from.
- Extra functions: Max./Min. value, low battery indication, auto power off, data hold.



▶ NT-311 Digital Temperature Humidity Meter



For Home, warehouse, Internet server center and more

Features:

- Large LCD display, easy to read
- Integrating Temperature, Humidity, Clock, Alarm clock & Calendar Multi-functions.
- MAX. and MIN. temperature and humidity memory function
- 12-hour/24-hour displaying system selection.
- Wall hanging or desk-top stand support.

Specification	
Temperature range	-10 ~ +50°C / 14 ~ 122°F
Humidity range	20%RH~90%RH
Accuracy	±1°C (±1.8°F) / ±5%RH 32 ~ 112°F : ±1.8°F 40% ~ 80%RH : ±8%RH
Resolution	0.1°C (0.1°F) / 1%RH
Battery	AAA(1.5V) x 1pcs (Not included)
Size(mm/inch)	96x 103 x 20 / 3.8"x4.0"x0.8"
Individual packing	Blister card

▶ NT-6352 3 in 1 Metal Voltage Stud Detector

CE RoHS COMPLIANT Fast, accurate, easy to use, LED & buzzer indicators



Features:

- Combined unit to accurately detect live or dead electricity cables, water or gas pipes and wooden studs or battens
- LED & buzzer indicators
- Depth penetration 18~20mm (0.7 to 0.8 inches)
- Uses precision screwdriver for easy unit sensitivity adjustment
- Power source: NEDA1604/6F22 (9V) x 1pcs(Not included)
- Size: 178 x 120 x 34.7mm (7 x 4.8 x 1.4 inches)

Individual packing: Color box

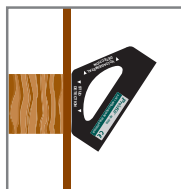

Wooden stud detection

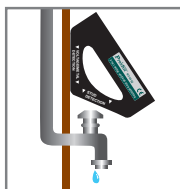

Metal detection

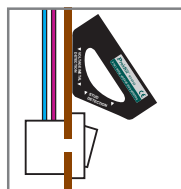

Wiring detection

▶ NT-312 Digital Temperature Humidity Meter With Probe



For Home, office use, indoor & outdoor measuring

Features:

- Economical way to monitor ambient temperature and humidity as well as outdoor temperature via remote temperature probe.
- Large LCD display, easy to read.
- MAX. and MIN. temperature and humidity memory automatic update functions.
- Wall hanging or desk-top stand support.

Specification	
Temperature range	Indoor: -10° ~ +50°C (14 ~ 122°F)±1°C(±1.8°F) Outdoor: -50° ~ +70°C (-58°~+158°F)±1°C(±1.8°F)
Humidity range	20% RH ~ 90%RH±5%RH
Resolution	0.1°C (0.1°F) / 1%RH
Battery	AAA(1.5V) x 1pcs (Not included)
Size(mm/inch)	96x 103 x 20 / 3.8"x4.0"x0.8"
Individual packing	Blister card

▶ NT-306 Non-Contact Voltage Detector

CE **CAT IV 1000V**



Warning:
• Never test voltage more than 1000 VAC
• Test voltage range: 90V~1000 VAC

Features:

- Built-in white LED illumination light provides convenient work in dark areas
- Compact size with pocket clip easily fits into pockets or tool pouches
- Red LED and audible alarm if voltage is present
- Entire outer surface is non-conductive for safety, helps avoid high voltage shock
- Powered by two 1.5V AAA batteries (not included)
- CAT IV 1000V Safety rating.
- Applications: Electricians, maintenance staffs, service and safety personnel, and even homeowners
- Detects AC voltage from 90 to 1000 VAC without metallic contact

Individual packing: Blister card



Red LED and audible alarm if voltage is present



Built-in white LED illumination light



Detects AC voltage from 90 to 1000 VAC

MT-9906/MT-9907 Test Leads



Features:

- One pair (one red, one black) comfort grip probes with protective cap for user comfort and safety
- Durable quality PVC insulated test leads with right-angle shrouded banana plugs
- Banana plugs are molded directly to the wire for superior pull strength
- Needle tip test probe, allowing easy access of hard to reach test points
- Compatible with most of multimeters that accept safety style sheath banana plugs

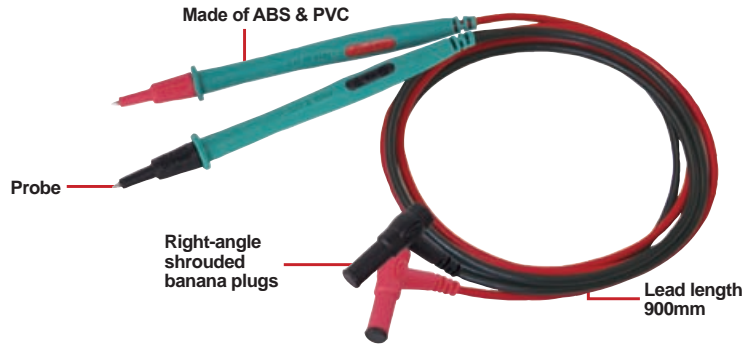

MT-9906 Specification	
Probe	Ø2x17mm
Hand piece	129mm
Lead length	900mm
Plug	Ø4.2x15mm
OAL	1045mm/41.1"
Weight	78.5g

MT-9907 Specification	
Probe	Ø2x17mm
Hand piece	109mm
Lead length	900mm
Plug	Ø4.2x15mm
OAL	1025mm/40.4"
Weight	74g

Individual packing: Blister card

400-029/400-030 Receptacle Testers



Features:

- Tests for correct wiring, open ground, reverse polarity, open hot, open neutral, hot on neutral, hot and ground reversed with open hot and ground fault interruption in 3-wire, 120VAC circuits
- Model 400-030 features proper operation GFI receptacles testing.

Individual packing: Blister card

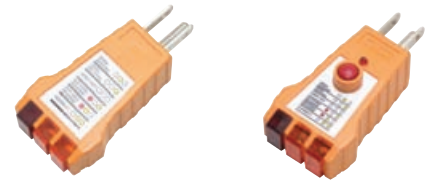

400-029

400-030

Light pattern indicates condition of wiring.

<p>OPEN GROUND ○ ● ○ Ground contact not connected</p> <p>HOT/GRD REVERSE ● ○ ● Hot and ground contacts interchanged</p>	<p>OPEN NEUTRAL ○ ○ ● Neutral contact not connected</p> <p>OPEN NEUTRAL ● ● ○ Hot and neutral contacts interchanged</p>	<p>OPEN HOT ○ ○ ○ Hot contact not connected</p> <p>CORRECT ○ ● ● Receptacle is wired correctly</p>
---	---	--

● Red is on ● Amber is on ○ Light is off

6HP-9xxx Series Oscilloscope Probe Kit



Features:

- Switchable X1/X10 attenuation with reference switch positions.
- Break-resistant center conductor & wide compensation range.
- Flatter response, sharper leading edges.
- Faster rise time and replaceable cable probe head tip and ground lead.
- Max. input voltage: 600V (DC-peak AC).
- Includes BNC adapter, IC tip, insulating tip & trimming tool.

Individual packing: Pouch bag

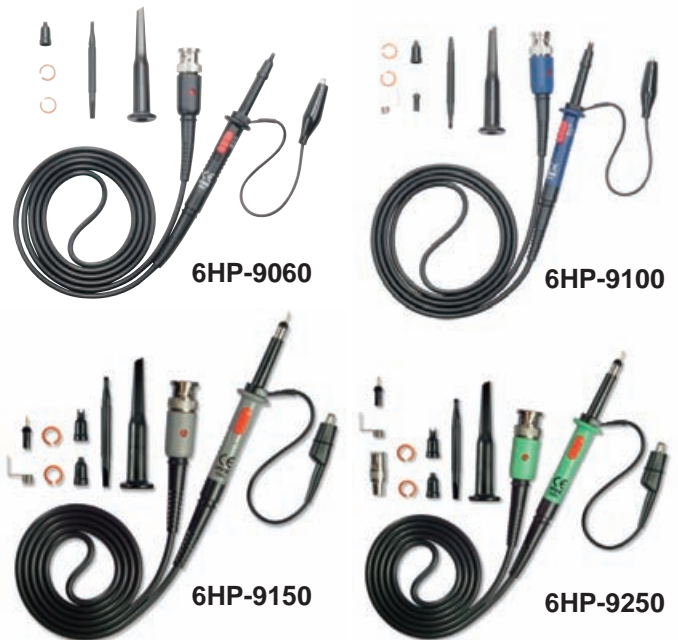

Switchable series							
Model No.	Attn.	Readout	Input impedance	Band width	Resetime	Max input V	Compensation range
6HP-9060	x1	No	1MΩ 91PF	6MHz	58ns	300VDC	NA
	x10		10MΩ 18PF	60MHz	5.8ns	600VDC	10-35PF
6HP-9100	x1		1MΩ 56PF	6MHz	58ns	300VDC	NA
	x10		10MΩ 13PF	100MHz	3.5ns	600VDC	10-35PF
6HP-9150	x1		1MΩ 5PF	6MHz	58ns	300VDC	NA
	x10		10MΩ 13PF	150MHz	2.3ns	600VDC	10-35PF
6HP-9250	x1		1MΩ 56PF	6MHz	58ns	300VDC	NA
	x10		10MΩ 13PF	250MHz	1.4ns	600VDC	10-35PF

PRECISION PLIERS & CUTTERS



Pro'sKit® Precision Pliers

Cutting edge shapes:

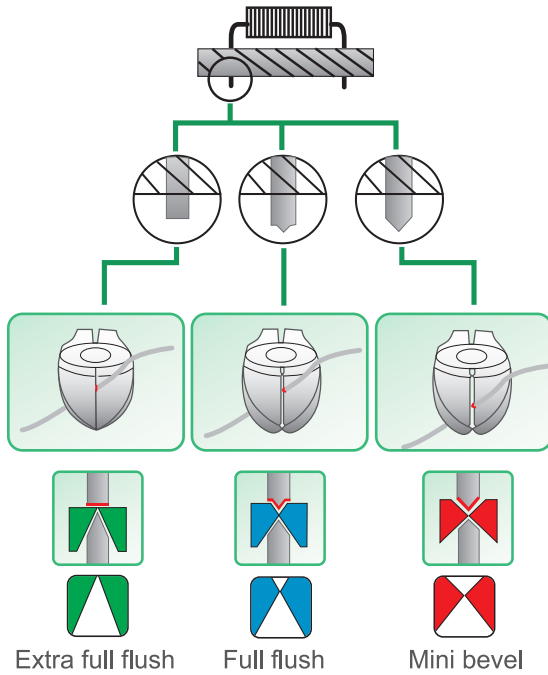

All of Pro'sKit® pliers are made of high quality steel to ensure excellent performance and long life. A variety of materials are used for Pro'sKit® pliers, including: Middle Carbon Steel (S45C, S50C, S55C, SK7, SK5), High Carbon Steel (S60C), High Carbon Tool Steel (SAE 1085), Chrome Vanadium Steel (CrV, SAE 6168, SAE 6150), Chrome-molybdenum Vanadium Steel (SCM 440), Stainless Steel (AISI 420, 410, 420J2, 420K2).

- The overall lengths of most Precision Pliers range from 90 to 145mm (4" to 5-1/2") and are great for use on flattening, bending, holding and cutting precise electronic components, wires and PCB. They are also popular in the jewelry industry.
- The overall lengths of most Electrical Pliers range from 150 to 230mm (6" to 9"), suited for cutting various kinds of heavy duty metal wires, mainly used in electronic, automobile, building field.

Basic shapes of jaws :

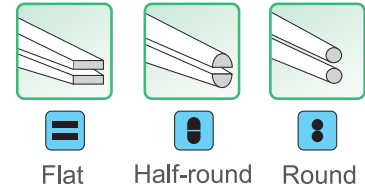

Gripping surfaces:



Finish of Pliers:



Handles:



Spring:

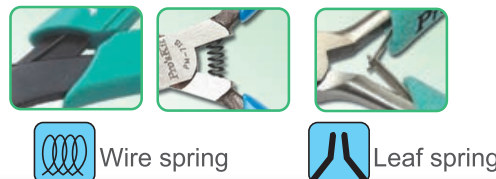

Pliers Technical Basics

Spring



Wire Spring

Precision pliers with double leaf springs or wire spring to keep the handles always self-opening to supply smooth and efficient operation.



Leaf spring

Gripping surfaces

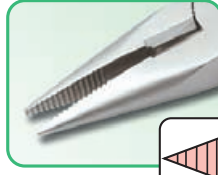

Serrated

Serrated jaws provide a good grip but serrations can mar jewelry when you exert force excessively.

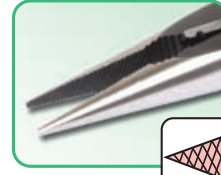

Crosswise serrated

Crosswise serrated jaws provide the best grip, suited for pulling and cutting various kinds of heavy duty metal wires whatever in horizontal or vertical angles, but serrations will cause abrasion when exerting force too much.

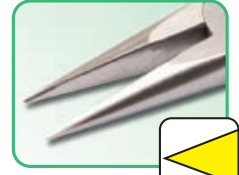

Smooth

Smooth jawed pliers are unlikely to mar objects but do not provide good grip. Suited for flattening wire, flattening pins and precision assembly work.

Shapes of jaws:

- **Flat jaws** : Mainly used in gripping and holding flat or square objects securely and for making angular bends. Insides of jaws may be smooth or serrated. Typically design for electric pliers and electronic flat nose pliers.

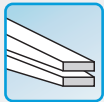

- **Half-round jaws** : Mainly used in holding objects, pulling wires and bending wires. Insides of jaws may be smooth or serrated. It is widely designed in various needle nose pliers.

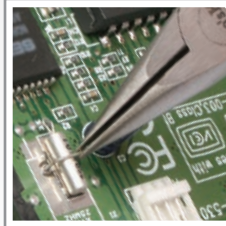
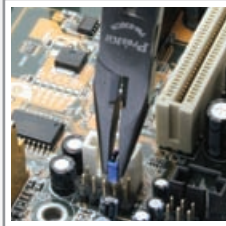
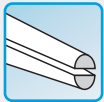

- **Round jaws** : Mainly used in making bends, loops, circles, coils from wire or sheet metal. Tapered circular jaws are smooth so that they will not scratch or nick soft metals. It is popular in the jewelry industry

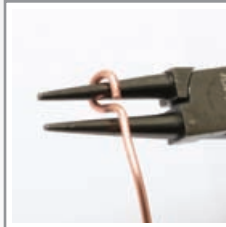
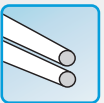

Cutting edge shapes:



Without bevel : This kind of cutting edge shape is usually designed in micro nippers, precision electronic pliers, plastic cutting pliers. Its blades are very sharp, suited for cutting soft wire up to $\varnothing 1.0\text{mm}$ (AWG 18).



Small outside bevel : This kind of cutting edge shape is usually designed in electronic pliers, suited for cutting soft wire, copper wire from 0.6 to $\varnothing 1.2\text{mm}$ (AWG 22 to 16) or small components.



Outside bevel : It is usually designed in electric pliers, needle pliers, suited for cutting thick copper wire or hard iron wire from $\varnothing 0.8$ to $\varnothing 1.6\text{mm}$ (AWG 20 to 14) or heavy duty metal pins.

Safety Caution



- When using cutting pliers, please wear protective goggles and gloves and beware of wire ends flying off.
- Each tool should only be used for its specified purpose.
- Only handles marked with the symbol  1000V are insulating.



▶ 200-002 5" Economy Flush Cutter

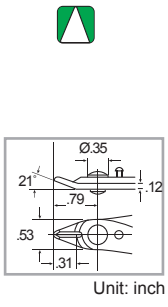

Material	HRC		Application	OAL. (mm/inch)
	Body	Cutting edge		
SK7	50'±3'	50'±3'	Ø 1.6mm 14AWG	125/4.9

▶ 200-071 5" Precision Flush Cutter

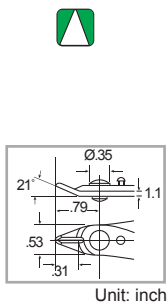

Material	HRC		Application	OAL. (mm/inch)
	Body	Cutting edge		
SK7	50'±3'	50'±3'	Ø 1.3mm 16AWG	130/5.1

▶ 902-077 5" Micro Cutting Plier

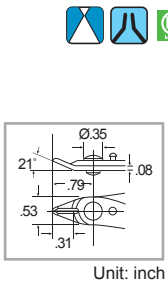

Material	HRC		Application	OAL. (mm/inch)
	Body	Cutting edge		
SK5	50'±3'	55'±3'	Ø 1.6mm 14AWG	130/5.1

▶ 902-011 5" Micro Cutter

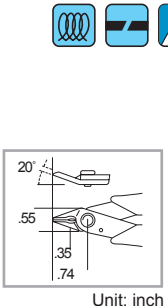

Material	HRC		Application	OAL. (mm/inch)
	Body	Cutting edge		
SK5	48'±3'	55'±3'	Ø 1.2mm 16AWG	125/4.9

▶ 902-075/902-076 5" Micro Cutting Plier



902-076 with safety clip
Safety clip design prevents flying leads, good for PC board lead trimming, or any soldered wire leads cutting to ensure user's safety.

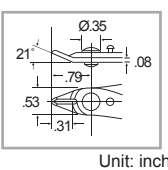

Model No.	Material	HRC		Application		OAL. (mm/inch)
		Body	Cutting edge	Soft steel	Copper	
902-075	SK5	50'±3'	50'±3'	Ø 0.8mm 20AWG	Ø 1.6mm 14AWG	130/5.1
902-076						

Specialty Electronics Pliers
High quality

- Clean and smooth cutting
- Light for easy operation
- Particularly made for electronic and precision field
- Cut copper wire only

Material: SK7
High carbon steel
Hardness: HRC50*



Individual packing: Blister Card

▶ 200-088 5" Micro Cutter

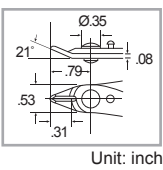

Material	HRC		Application		OAL. (mm/inch)
	Body	Cutting edge	Soft steel	Copper	
SK5	50'±3'	55'±3'	Ø 0.8mm 20AWG	Ø 1.6mm 14AWG	130/5.1

▶ 200-080 2 in 1 Wire Stripper/Cutter



Material	HRC Body	Application		OAL. (mm/inch)
		Cutter:Ø1.2mm	Stripper:0.4~1.6mm² (26~14AWG)	
AISI 420	48'±3'			130/5.1

Specialty Electronic Pliers Conductive Handle

- Made from high carbon steel. Accurately machined, these high quality precision tools are designed for fine assembling and adjustment operations on electronic circuits.
- Provide easy work on high density PC board
- Conductive handle



Individual packing:
Blister Card

▶ 100-007 5" ESD Safe Plier

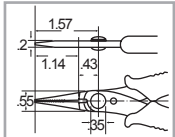

Unit: inch

Material	HRC		Application Copper	OAL. (mm/inch)
	Body	Cutting edge		
S50C	50±3°	50±3°		140/5.5

▶ 200-040 5" ESD Safe Micro Cutter

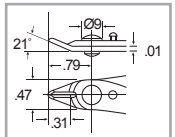

Unit: inch

Material	HRC		Application Copper	OAL. (mm/inch)
	Body	Cutting edge		
SK7	50±3°	50±3°	Ø 1.3mm 16AWG	130/5.1

▶ 200-083 5" ESD Safe Clean Cut Micro Nipper

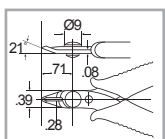

Unit: inch

Material	HRC		Application Copper	OAL. (mm/inch)
	Body	Cutting edge		
SK7	50±3°	50±3°	Ø 0.8mm 20AWG	120/4.7

▶ 5" ESD Safe Cutter

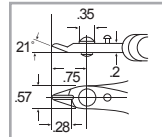

Unit: inch



200-041

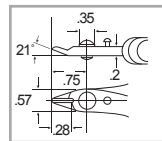

Unit: inch



200-082
with safety clip



Safety clip design prevents flying leads, good for PC board lead trimming, or any soldered wire leads cutting to ensure user's safety.

Model No.	Material	HRC		Application Copper	OAL. (mm/inch)
		Body	Cutting edge		
200-041	S50C	50±3°	50±3°	Ø 2.0mm 12AWG	125/4.9
200-082					

▶ PM-251 Cutting Plier

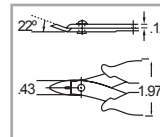

Unit: inch

Material	HRC		Application Copper	OAL. (mm/inch)
	Body	Cutting edge		
AISI 420J2	48±3°	48±3°	Ø 1.3mm 16AWG	122/4.8

▶ PM-252 Bent Nose Plier

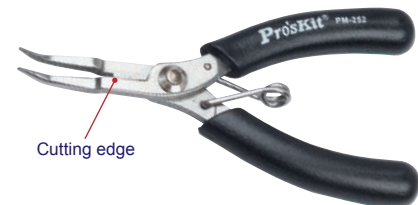

Cutting edge

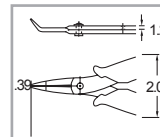

Unit: inch

Material	HRC		Application Copper	OAL. (mm/inch)
	Body	Cutting edge		
AISI 420J2	43~46°	43~46°	Ø 1.0mm 18AWG	118/4.6

▶ PM-254 Long Nose Plier

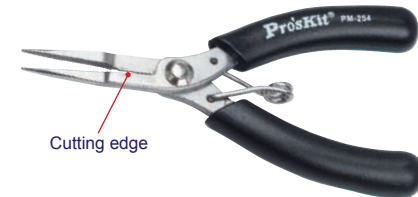

Cutting edge

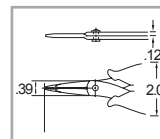

Unit: inch

Material	HRC		Application Copper	OAL. (mm/inch)
	Body	Cutting edge		
AISI 420J2	43~46°	43~46°	Ø 1.0mm 18AWG	118/4.6

PM-396G Stainless Long Nose Plier

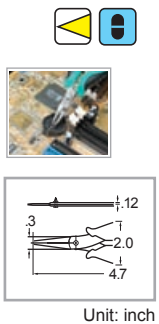

Material	HRC	OAL. (mm/inch)
AISI 420	43°±3°	120/4.7

Unit: inch

PM-396H Stainless Flat Nose Plier

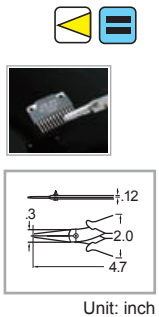

Material	HRC	OAL. (mm/inch)
AISI 420	43°±3°	120/4.7

Unit: inch

PM-396K Stainless Cutting Plier

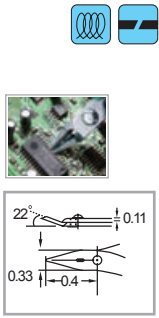

Super Slim

Material	HRC	Application Copper	OAL. (mm/inch)	Individual packing
AISI 420	48°±3°	Ø 0.1-1.0mm	115/4.53	Blister Card

Unit: inch

PM-396J Stainless Round Nose Plier

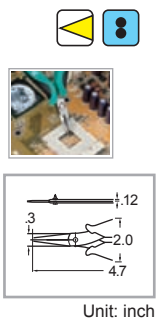

Material	HRC	OAL. (mm/inch)
AISI 420	43°±3°	120/4.7

Unit: inch

100-046 6" Long Nose Plier

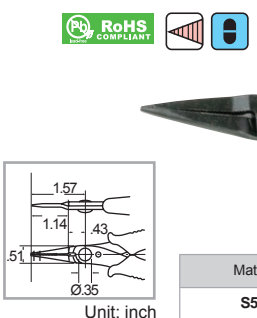

Material	HRC	OAL. (mm/inch)
S55C	Body 52°±2°	150/5.9

Unit: inch

Stainless Specialty Electronic Pliers

- Made of AISI420 stainless steel which assures cleanliness and corrosion-resistance.
- Dual color non-slip TPR handles for user comfort.
- Polyoxymethylene (POM) spring for self-opening action to supply smooth operation.



Individual packing: Blister Card

PM-396I Stainless Bent Nose Plier

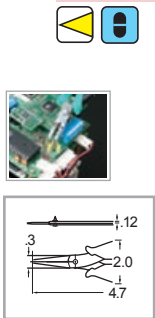

Material	HRC	OAL. (mm/inch)
AISI 420	43°±3°	120/4.7

Unit: inch

PM-396F Stainless Cutting Plier

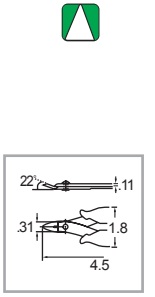

Material	HRC	Application Copper	OAL. (mm/inch)
AISI 420	48°±3°	Ø 1.3mm/16AWG	115/4.5

200-092 5" Micro Cutter

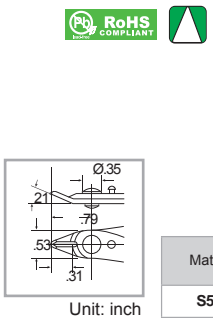

Material	HRC		Application Copper	OAL. (mm/inch)
	Body	Cutting edge		
S55C	52°±2°	60°±3°	Ø 1.3mm/16AWG	130/5.1

Unit: inch

Precision Stainless Steel Pliers Mirror Polished

- Made of stainless steel with mirror polished finish
- Leaf springs are spot welded to the tool handles to fix the jaws in a comfortable position
- Forged box joint construction gives strength and precision



Forged box joint

Double leaf springs, are easy operation and user comfort

High grade alloy steel, hot drop forged, oil hardened and tempered for long life and perfect precision work

Dipped handle for user comfort



Individual packing: Blister Card

▶ 100-011 5" Needle Nose Plier

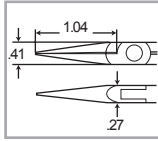

Unit: inch

Material	HRC	OAL. (mm/inch)
	Body	
AISI 420	45°±3°	125/4.9

▶ 100-013 5 1/2" Needle Nose Plier

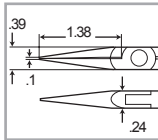

Unit: inch

Material	HRC	OAL. (mm/inch)
	Body	
AISI 420	48°±3°	135/5.3

▶ 200-056 4 1/2" Semi-Flush Diagonal Cutter

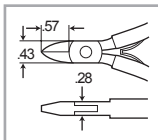

Unit: inch

Material	HRC Body	Application			OAL. (mm/inch)
		Hard steel	Soft steel	Copper	
AISI 420	45°±3°	Ø 0.8mm 20AWG	Ø 1.3mm 16AWG	Ø 2.0mm 12AWG	110/4.3

▶ 200-057 4 1/2" Full-Flush Diagonal Cutter

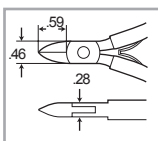

Unit: inch

Material	HRC Body	Application			OAL. (mm/inch)
		Hard steel	Soft steel	Copper	
AISI 420	45°±3°	Ø 0.8mm 20AWG	Ø 1.3mm 16AWG	Ø 2.0mm 12AWG	110/4.3

▶ 200-058 4 1/2" Slim Full Flush Diagonal Cutter

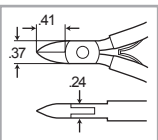

Unit: inch

Material	HRC Body	Application			OAL. (mm/inch)
		Hard steel	Soft steel	Copper	
AISI 420	45°±3°	Ø 0.8mm 20AWG	Ø 1.3mm 16AWG	Ø 1.6mm 14AWG	110/4.3

▶ 200-059 4 1/2" Full-Flush Straight Side Cutter

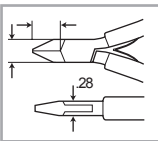

Unit: inch

Material	HRC Body	Application			OAL. (mm/inch)
		Hard steel	Soft steel	Copper	
AISI 420	45°±3°	Ø 0.8mm 20AWG	Ø 1.3mm 16AWG	Ø 2.0mm 12AWG	110/4.3

▶ 100-014 5 1/2" Bent Nose Plier

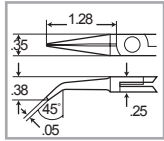

Unit: inch

Material	HRC	OAL. (mm/inch)
	Body	
AISI 420	48 \pm 3*	135/5.3

▶ 100-017 6" Needle Nose Plier

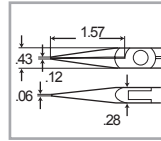

Unit: inch

Material	HRC	OAL. (mm/inch)
	Body	
AISI 420	48 \pm 3*	145/5.7

▶ 100-015 5 1/2" Flat-Nose Plier

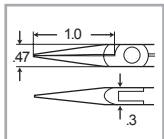

Unit: inch

Material	HRC	OAL. (mm/inch)
	Body	
AISI 420	48 \pm 3*	130/5.1

▶ 100-012 6" Needle Nose Plier

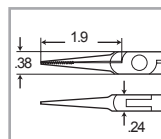

Unit: inch

Material	HRC	OAL. (mm/inch)
	Body	
AISI 420	48 \pm 3*	140/5.5

▶ 200-060 5" Flush Oblique Cutter Slim Tip Plier

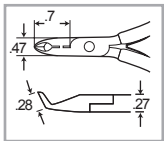

Unit: inch

Material	HRC Body	Application			OAL. (mm/inch)
		Hard steel	Soft steel	Copper	
AISI 420	45 \pm 3*	Ø 0.8mm 20AWG	Ø 1.0mm 18AWG	Ø 1.6mm 14AWG	125/4.9

▶ 100-006 7 1/2" Long Nose Flat Blade Plier

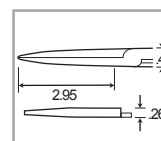

Unit: inch

Material	HRC	OAL. (mm/inch)
	Body	
AISI 420	48 \pm 3*	185/7.3

▶ 100-025 5" Long Nose Plier

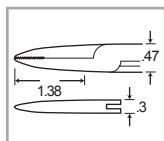

Unit: inch

Material	HRC	OAL. (mm/inch)
	Body	
AISI 420	48 \pm 3*	140/5.5

▶ 200-067 5" Side Cutting Plier

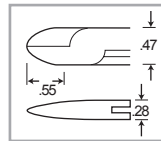

Unit: inch

Material	HRC Body	Application			OAL. (mm/inch)
		Hard steel	Soft steel	Copper	
AISI 420	48 \pm 3*	Ø 0.8mm 20AWG	Ø 1.6mm 14AWG	Ø 2.0mm 12AWG	125/4.9

Precision Pliers

- High quality carbon steel S45C forged, hardened, finished with nickel plating for corrosion resistance.
- Spring-loaded for self-opening action to reduce fatigue during long term operation.
- Dual color, non-slip TPR handles for user comfort.
- Particularly designed for electronic and precision field.



Cutting edge additionally induction-hardened, hardness of HRC50~55*

Made from S45C with nickel plating for corrosion resistance

Dual color, non-slip TPR handles

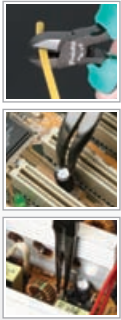

Individual packing: Blister Card

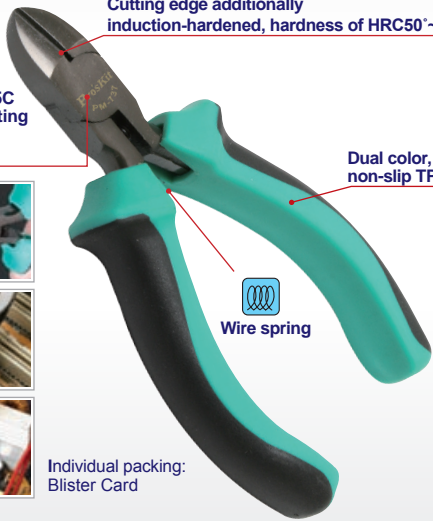

▶ PM-731 Mini Lineman's Plier

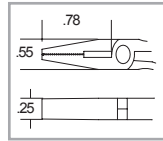

Unit: inch

Material	HRC	Application	OAL. (mm/inch)
	Cutting edge	Copper	
S45C	50~55*	Ø 1.0mm	120/4.7

▶ PM-736 Long Nose Plier

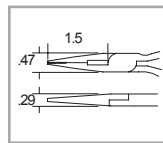

Unit: inch

Material	HRC	Application	OAL. (mm/inch)
	Cutting edge	Copper	
S45C	50~55*	Ø 1.0mm/18AWG	135/5.3

▶ PM-754 Flat Nose Plier

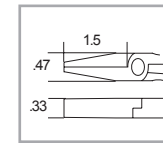

Unit: inch

Material	HRC	OAL. (mm/inch)
	Cutting edge	
S45C	50~55*	138/5.4

▶ PM-755 Bent Nose Plier

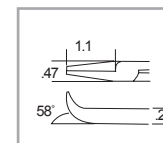

Unit: inch

Material	HRC	OAL. (mm/inch)
	Cutting edge	
S45C	50~55*	135/5.3

▶ PM-737 Diagonal Cutting Plier

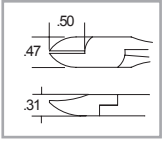

Unit: inch

Material	HRC	Application	OAL. (mm/inch)
	Cutting edge	Copper	
S45C	50~55*	Ø 1.0mm/18AWG	115/4.5

▶ PM-746 Needle Nose Plier

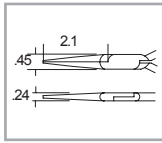

Unit: inch

Material	HRC	OAL. (mm/inch)
	Cutting edge	
S45C	50~55*	150/5.9

▶ PM-808 Plastic Cutting Plier



Material		HRC		Application	OAL. (mm/inch)
Body	Handle	Body	Cutting edge	Copper	
High carbon steel	PVC	45°±2'	59°±2'	Ø 0.3-1.3mm	117/4.61

Perfect for cutting parts off the sprue/Runner/Gate

- Made of high carbon steel with fine polish finish.
- Perfectly aligned cutter blades, all cutting edges tempered and hardened.
- Tapered and relieved head is thin and slim allowing use in hard to reach areas.

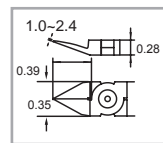

Unit: inch



Super Slim Style



Cut off parts from sprue

▶ 100-042 6" Needle-Nose Plier

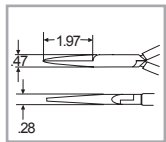

Unit: inch

Material	HRC		OAL. (mm/inch)
	Body		
S45C	43±3*		150/5.9

▶ 100-044 5" Flat-Nose Plier

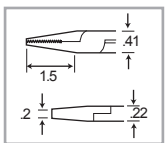
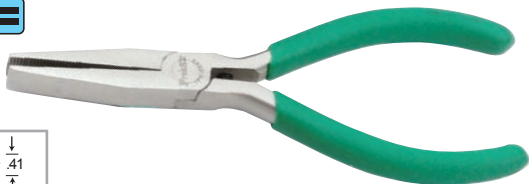

Unit: inch

Material	HRC		OAL. (mm/inch)
	Body		
S45C	43±3*		135/5.3

▶ 100-004 5" Bent-Nose Plier

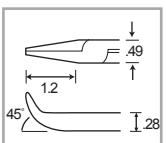
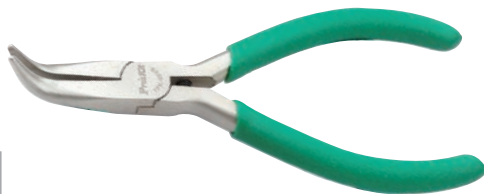

Unit: inch

Material	HRC		OAL. (mm/inch)
	Body		
S45C	43±3*		130/5.1

▶ 100-003 5" Long-Nose Plier

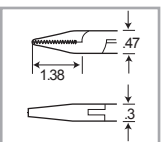

Unit: inch

Material	HRC		Application		OAL. (mm/inch)
	Body	Cutting edge	Hard steel	Copper	
S45C	43±3*	48±3*	Ø 0.8mm 20AWG	Ø 1.6mm 14AWG	136/5.4

▶ 100-040 5 1/2" Long Nose Plier

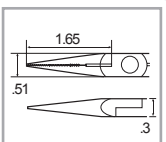

Unit: inch

Material	HRC		Application Hard steel	OAL. (mm/inch)	Individual packing
	Body	Cutting edge			
SAE 6140	45±3*	62±3*	Piano wire: Ø1.2mm (under HRC: 45)	140/5.5	Blister Card

**Non-Slip Handles
Precision Pliers**

- Clean and smooth cutting
- Lightweight design for easy operation
- Particularly designed for electronic and precision field



Material: S45C
Carbon steel

Nickel-iron plated

Wire spring for self-opening

Non-Slip handles
PVC plastic coated



Individual packing:
Blister Card

▶ 200-037 4 1/2" Diagonal Cutter Plier

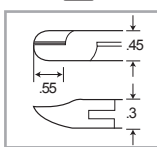

Unit: inch



Material	HRC		Application			OAL. (mm/inch)
	Body	Cutting edge	Hard steel	Soft steel	Copper	
S45C	43±3*	48±3*	Ø 0.8mm 20AWG	Ø 1.3mm 16AWG	Ø 1.6mm 14AWG	110/4.3

▶ 200-087 5" Heavy Duty Cutter

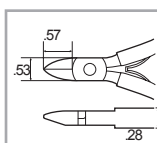

Unit: inch



Material	HRC		Application Hard steel	OAL. (mm/inch)	Individual packing
	Body	Cutting edge			
SAE 6140	45±3*	62±3*	Piano wire: Ø0.5mm (under HRC: 45)	125/4.9	Blister Card

PRECISION CUTTERS



- Ergonomic, non-slip handle with ensures great operator comfort.
- Leaf spring, energy saving design for efficient work.

Cutting edge:
HRC55±3

Adjustable screw

Made of 65CRM

Ergonomic
TPR handle



Leaf spring
Spring-loaded for
self-opening action



Individual packing: Blister Card

▶ PM-771 Diagonal Cutters Oval Head

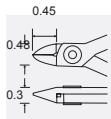

Unit: inch

Material	HRC		Application Copper	OAL. (mm/inch)
	Body	Cutting edge		
65 CRM	55°±3°	55°±3°	Ø 0.1-1.3mm	115/4.53

▶ PM-773 Diagonal Cutters Tapered And Relieved Head

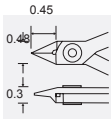

Unit: inch

Material	HRC		Application Copper	OAL. (mm/inch)
	Body	Cutting edge		
65 CRM	55°±3°	55°±3°	Ø 0.1-1.3mm	115/4.53

▶ PM-774 Diagonal Cutters Tapered Head

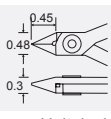

Unit: inch

Material	HRC		Application Copper	OAL. (mm/inch)
	Body	Cutting edge		
65 CRM	55°±3°	55°±3°	Ø 0.1-1.3mm	115/4.53

▶ PM-760 Diagonal Cutters Oval Head

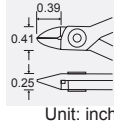

Unit: inch

Material	HRC		Application Copper	OAL. (mm/inch)
	Body	Cutting edge		
65 CRM	55°±3°	55°±3°	Ø 0.2-1.3mm	115/4.53

▶ PM-761 Diagonal Cutters Oval Head

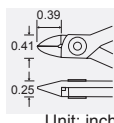

Unit: inch

Material	HRC		Application Copper	OAL. (mm/inch)
	Body	Cutting edge		
65 CRM	55°±3°	55°±3°	Ø 0.1-1.3mm	115/4.53

▶ PM-763 Diagonal Cutters Tapered And Relieved Head

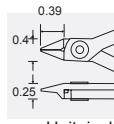

Unit: inch

Material	HRC		Application Copper	OAL. (mm/inch)
	Body	Cutting edge		
65 CRM	55°±3°	55°±3°	Ø 0.1-1.3mm	115/4.53

▶ PM-764 Diagonal Cutters Tapered Head

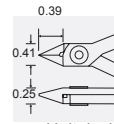

Unit: inch

Material	HRC		Application Copper	OAL. (mm/inch)
	Body	Cutting edge		
65 CRM	55°±3°	55°±3°	Ø 0.1-1.3mm	115/4.53

▶ PM-765 Diagonal Cutters Tapered Head

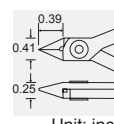

Unit: inch

Material	HRC		Application Copper	OAL. (mm/inch)
	Body	Cutting edge		
65 CRM	55°±3°	55°±3°	Ø 0.2-1.3mm	115/4.53

Precision Pliers with Adjustable Screw

- Adjustable screw insures precise cuts every time.
- Made of high-quality 63CRM material, precise and durable
- Ergonomic, non-slip handle with dual colors ensures great operator comfort
- Leaf spring, energy saving design for efficient work

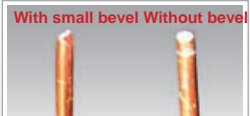
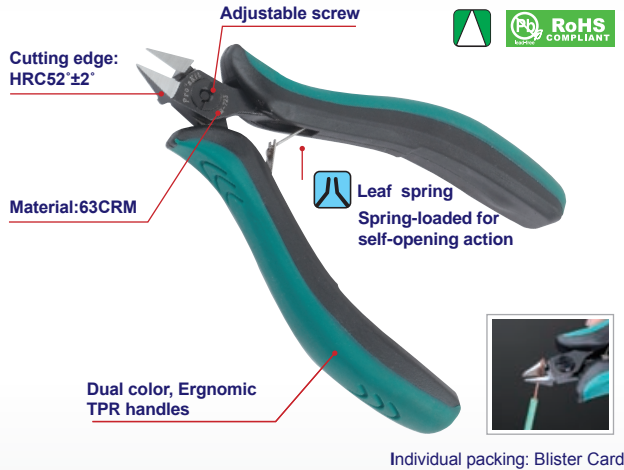

Smooth surface is cut
(By PM-721/PM-723)



Adjustable screw
(By PM-720/PM-721/PM-723)



▶ PM-721 Diagonal Flush Cutting Nipper

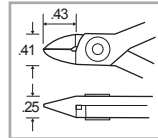

Unit: inch

Material	HRC	Application	OAL.
	Body	Copper	(mm/inch)
63CRM	55±3°	Ø 1.3mm/16AWG	115/4.5

▶ PM-723 Diagonal Flush Cutting Nipper

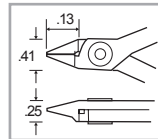

Unit: inch

Material	HRC	Application	OAL.
	Body	Copper	(mm/inch)
63CRM	55±3°	Ø 1.3mm/16AWG	115/4.5

▶ PM-727 Cutting Plier

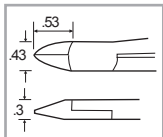

Unit: inch

Material	HRC	Application	OAL.
	Body	Copper	(mm/inch)
SAE 6050	40±3°	Ø 1.3mm/16AWG	130/5.1

▶ PM-728 Cutting Plier

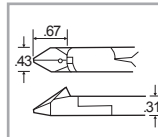

Unit: inch

Material	HRC	Application	OAL.
	Body	Copper	(mm/inch)
SAE 6050	40±3°	Ø 1.3mm/16AWG	130/5.1

▶ 902-078 4 1/2" Precision Cutting Plier

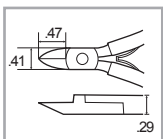

Unit: inch

Material	HRC		Application	OAL.
	Body	Cutting edge	Copper	(mm/inch)
AISI 6140	45±3°	61±3°	Ø 2.0mm/12AWG	120/4.7

▶ 902-079 5" Extra Long Nose Plier

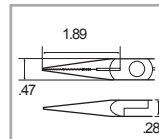

Unit: inch

Material	HRC		Application		OAL.
	Body	Cutting edge	Hard steel	Copper	(mm/inch)
AISI 6140	45±3°	61±3°	Ø 0.8mm/20AWG	Ø 2.0mm	155/6.1

ESD Safe Pliers and Cutters

- Made of high-quality carbon steel with nickel plating
- ESD safe, soft touch cushioned handle provides a secure hold and comfort.
- With double leaf springs for self-opening action
- Individual packing: Blister card



▶ PK-ST902 4 PCS Ergonomic ESD Safe Plier And Cutter Kit



Contents	
PM-055CN /PM-023CN/PM-037CN/PM-036CN	

▶ PM-036CN 5" Snipe Nose Plier

Material	HRC		Application			OAL. (mm/inch)
	Body	Cutting edge	Hard steel	Soft steel	Copper	
S45C	43'±2'	52'±2'	Ø 0.8mm 20AWG	Ø 1.3mm 16AWG	Ø 1.6mm 14AWG	127/5.0

Unit: inch

▶ PM-029CN 5" Round Nose Plier

Material	HRC: Body		OAL. (mm/inch)
	S45C	43'±2'	

Unit: inch

▶ PM-055CN 5" Bent Nose Plier

Material	HRC: Body		OAL. (mm/inch)
	S45C	43'±2'	

Unit: inch

▶ PM-023CN 4 1/2" Pointed Diagonal Plier

Cutting edge: HRC52'±2'

Material: Carbon steel with Nickel Plating, Body: HRC 43'±2'

Leaf spring

ESD safe cushioned grips for superior comfort and protection 10⁷~10⁹Ω

Unit: inch

Material	HRC		Application			OAL. (mm/inch)
	Body	Cutting edge	Hard steel	Soft steel	Copper	
S45C	43'±2'	52'±2'	Ø 0.8mm 20AWG	Ø 1.3mm 16AWG	Ø 1.6mm 14AWG	115/4.5

▶ PM-037CN 4 1/2" Diagonal Cutting Plier

Material	HRC		Application			OAL. (mm/inch)
	Body	Cutting edge	Hard steel	Soft steel	Copper	
S45C	43'±2'	52'±2'	Ø 0.8mm 20AWG	Ø 1.3mm 16AWG	Ø 1.6mm 14AWG	115/4.5

Unit: inch

▶ PM-046CN 6" Needle Nose Plier

Material	HRC: Body		OAL. (mm/inch)
	S45C	43'±2'	

Unit: inch

▶ PM-053CN 5" Flat Nose Plier

Material	HRC: Body		OAL. (mm/inch)
	S45C	43'±2'	

Unit: inch

ELECTRICAL PLIERS & CUTTERS



Electrical Insulated Tools

Pro'sKit® Insulated VDE Series come with high visibility molded ergonomic cushion handles for maximum comfort to ensure full force transfer through the grip. They also have been tested for dielectric strength under 10,000 Volts in a water bath in accordance with DIN EN 60900 (IEC 60900:2012) to encourage the users to trust a reliable insulation when live working up to 1000 Volt.

VDE tools are often used under extreme conditions, such as very low or very high temperature. Pro'sKit Insulation VDE Series are made from high grade materials, which have been tested by low-temperature impact test, high-temperature adhesive power test and burning test to offer more safety to users.



1000V
IEC 60900



Safety Caution



- Please keep your insulated tools dry and clean.
- Wear protective goggles and gloves when working.
- Do not touch the non-insulated parts when working live.

Testing Procedure



Dielectric Strength Test

Individual immersion test at 10,000 Volt to guarantee safety working up to 1000 Volt.

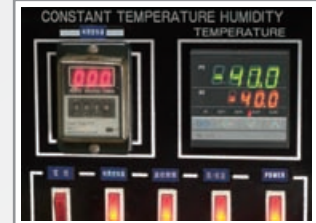

Low-temperature Impact Test

Cool the tools to -40°C then conduct the impact test. The insulation must retain its toughness and not break.

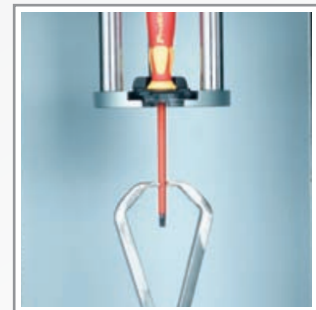
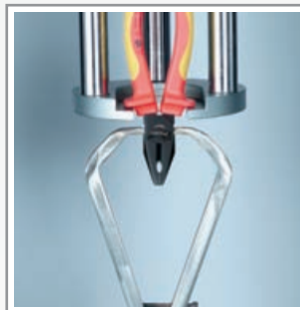

High-temperature Adhesive Power Test

After storage for 168 hours at 70°C, pull the insulated part with tensile force of 500Nm for 3 minutes. This test ensures that the insulation still stays firm and remain snug against the tool body.



Burning Behavior Test

Pro'sKit® insulated tools use flame-resistant plastics for insulation to protect users.

▶ **902-202 Insulated Wire Stripping Plier**



Material	HRC	Application		OAL. (mm/inch)
	Body	Hard steel	Soft steel	
AISI 6150	46 \pm 4 $^{\circ}$	Adjustable to accept conductors up to 10mm 2 /8AWG overall diameter		160/6.3

▶ **902-206 Insulated Side Cutter**



Material	HRC	Application		OAL. (mm/inch)
	Body	Hard steel	Soft steel	
AISI 6150	46 \pm 4 $^{\circ}$	\varnothing 2.0mm/12AWG	\varnothing 2.8mm/10AWG	165/6.5

▶ **902-205 Insulated Heavy Duty Side Cutter**



Material	HRC	Application		OAL. (mm/inch)
	Body	Hard steel	Soft steel	
AISI 6150	46 \pm 4 $^{\circ}$	\varnothing 2.7mm/10AWG	\varnothing 3.8mm/8AWG	200/7.9

▶ **902-207 Insulated Long Nose Plier**



Material	HRC	Application		OAL. (mm/inch)
	Body	Hard steel	Soft steel	
AISI 6150	46 \pm 4 $^{\circ}$	\varnothing 2.2mm/12AWG	\varnothing 3.2mm/8AWG	200/7.9

▶ **902-208 Insulated Long Nose Plier**



Material	HRC	Application		OAL. (mm/inch)
	Body	Hard steel	Soft steel	
AISI 6150	46 \pm 4 $^{\circ}$	\varnothing 1.6mm/14AWG	\varnothing 2.5mm/10AWG	170/6.7

Insulated VDE Pliers



- Certified to IEC 60900, VDE, and DIN 1,000V safety standards and bear GS sign.
- High visibility molded ergonomic cushion handle for maximum comfort.
- Hard chrome finish with PTFE coating for anti-rust protection.
- Drop forged from special tool steel.

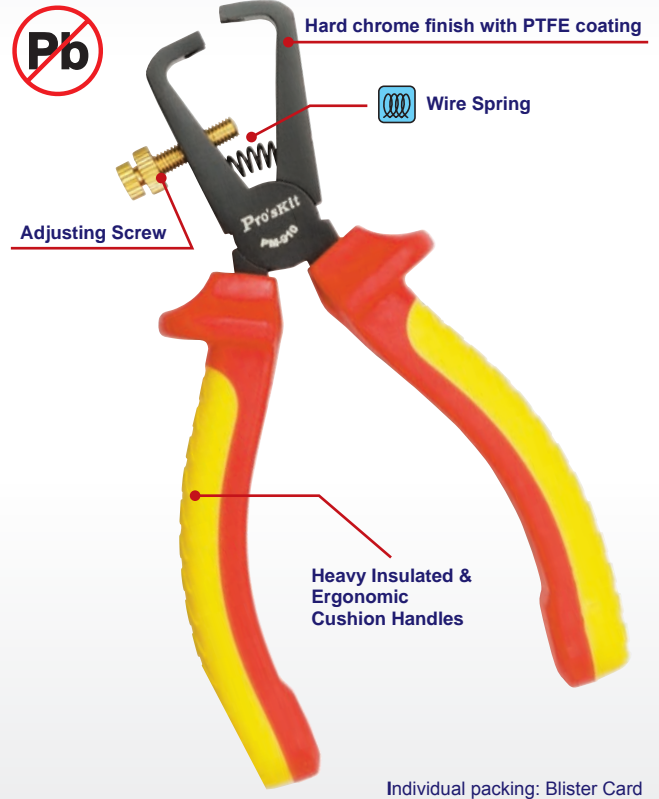

Individual packing: Blister Card

▶ **902-203 Insulated Combination Plier**



Material	HRC	Application		OAL. (mm/inch)
	Body	Hard steel	Soft steel	
AISI 6150	46 \pm 4 $^{\circ}$	\varnothing 2.5mm/10AWG	\varnothing 3.8mm/8AWG	195/7.7

▶ **902-204 Insulated Combination Plier**



Material	HRC	Application		OAL. (mm/inch)
	Body	Hard steel	Soft steel	
AISI 6150	46 \pm 4 $^{\circ}$	\varnothing 2.0mm/12AWG	\varnothing 3.1mm/8AWG	175/6.9

▶ **902-514 8" Diagonal Cutter**

- Closed box joint construction ensures smooth action and no handle wobble
- Body corrosion resistant finish and hardened cutting edge for long life
- Nonslip handle for comfort and ease of identification.



Material	HRC		Application			OAL. (mm/inch)	Individual packing
	Body	Cutting edge	Hard steel	Soft steel	Copper		
AISI 6150	45°±3°	62°±2°	20AWG	16AWG	14AWG	210/8	Blister Card

▶ **902-515 8" Long-Nosed Plier**

- Made of hardened steel for great durability
- Cutting edges are precision ground and hardened for long life
- Forged box joint construction gives strength and precision

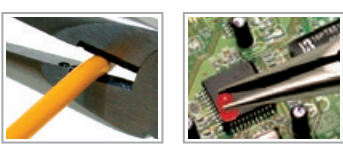

Material	HRC		Application			OAL. (mm/inch)	Individual packing
	Body	Cutting edge	Hard steel	Soft steel	Copper		
AISI 6150	45°±3°	62°±2°	20AWG	16AWG	14AWG	210/8	Blister Card

▶ **100-021 Long Nose Plier**

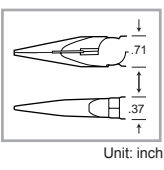

Material	HRC		Application			OAL. (mm/inch)
	Body	Hard steel	Soft steel	Copper		
S60C	48°±3°	Ø1.2mm 16AWG	Ø 2.0mm 12AWG	Ø2.6mm 10AWG	160/6.3	

Unit: inch

▶ **200-038 6" Diagonal Cutter**

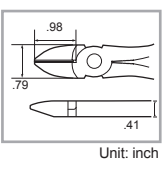

Material	HRC		Application			OAL. (mm/inch)
	Body	Hard steel	Soft steel	Copper		
S60C	48°±3°	Ø1.2mm 16AWG	Ø 2.0mm 12AWG	Ø2.6mm 10AWG	160/6.3	

Unit: inch

▶ **100-033 6" Slip-Joint Plier**

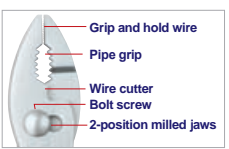
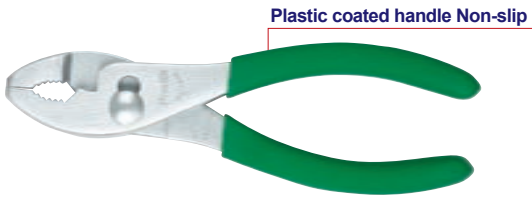

Material	HRC		Handle	OAL. (mm/inch)
	Body	Body		
S45C	38°±3°		PVC	154/6.1

▶ **902-049 Plastic Cutting Plier**

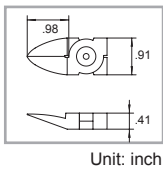

Material	HRC		Application	OAL. (mm/inch)
	Body	Cutting edge		
S55C	45°±3°	55°±3°	plastic	185/7.3

Unit: inch

⚠ This series of pliers are made for plastic cutting only

PM-924 9" Steel Wire Cutting Crimping Plier



Material		HRC		Application	OAL (mm/inch)
Body	Handle	Body	Cutting edge		
SCM440	TPR	45 ±3°	61 ±3°	For cutting round cable up to Ø 9.2mm (Ø3/8") and crimping non-insulated terminals with wire 1.25/2.0/5.5/8mm ² /AWG22-16/16-14/12-10/8	225/8.9

902-307 9.5" Lineman's Plier



Material	HRC		Application			OAL (mm/inch)
	Body	Handle	Hard steel	Soft steel	Soft steel	
Cr-V	45 ±3°		Piano wire: Ø2.5mm 10AWG	Ø 3.0mm 8AWG		238/9.5

902-246 8" Diagonal Cutting Plier

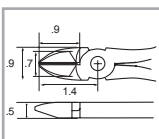

Unit: inch

Material	HRC Body	Cutting edge	Application			OAL (mm/inch)
			Hard steel	Soft steel	Copper	
S55C	40°~50°	55°±3°	Ø0.8mm 20AWG	Ø 2.0mm 12AWG	Ø2.6mm 10AWG	200/7.9

Steel Wire Cutting Crimping Plier

- Made of high quality SCM440 hot-riveted design features smooth, wobble-free operation.
- The high-leverage design provides greater cutting and gripping power
- Special design for cutting round cable with multi-conductor up to Ø3/8"



PM-924

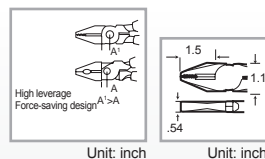

Unit: inch

Unit: inch

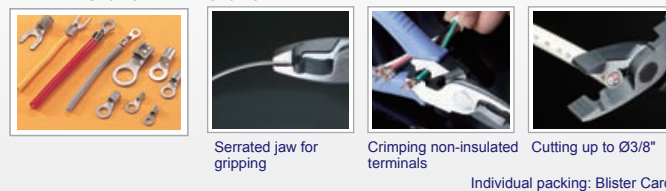

Serrated jaw for gripping

Crimping non-insulated terminals

Cutting up to Ø3/8"

Individual packing: Blister Card

100-039 Multi-Crimp Tool



- Wire cutter in nose
- Plastic-coated handle
- For crimping non-insulated terminals from 10 to 22 AWG

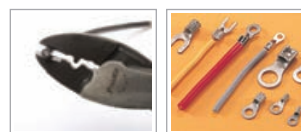

Material	Handle	HRC Body	Application		OAL (mm/inch)
			Hard steel	Crimping	
S60C	PVC	42 ±3°	Ø1.6mm 14AWG	Non-insulated terminal 10 ~ 22 AWG	248/9.8

Individual packing: Blister Card

100-022 Snap Ring Plier Set



- 3 convertible tip jaws can be changed easily for 6 different internal-external purposes

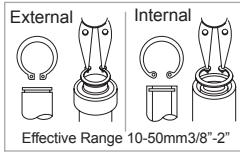

Material	Handle	HRC Body	Application Hard steel	OAL. (mm/inch)
S45C	PVC	43±3°	Effective range: 10-50mm (3/8"-2")	155/6.1

Individual packing: Blister Card

300-151 Strain Relief Bushing Assembly Tool



- Designed to install all sizes of strain relief bushing
- Close lock and return spring function



Material	Handle	Hardness Body	Application	OAL. (mm/inch)
Low carbon steel	PVC	HR30N58°	Thickness: 3mm/1/8"	170/6.7

Individual packing: Blister Card

200-046 Round Cable Cutter



- Made of S45C carbon steel
- Safety lock for easy storage
- For cutting Thick wire up to 2/0 (70mm²/00AWG) cable, 100 pair group telephone cable size



Spring



Safety lock



Cutting round cable



Material	Handle	HRC Body	Application	OAL. (mm/inch)
S45C	PVC	45±3°	16mm ² solid/4AWG, 35mm ² stranded/2AWG, 70mm ² flexible/00AWG	170/6.7

Individual packing: Blister Card

SR-228 Copper Clad Steel Coaxial Cable Cutter



- Body made of high quality S45C with black oxide finish for anti-rust.
- Palm-fit ergonomic cushion grip handle provides user comfort.
- Adjustable screw and nut ensures proper fix and durability
- Safety lock for easy storage



For cutting steel center conductor and keeping cable round

200-015 6 1/2" Round Cable Cutter



- Made of S45C carbon steel
- Safety lock for easy storage
- For cutting Multi-conductor cable up to 0.5" (12.7mm) and Strand wire up to 8 AWG (10mm²)



Cutting round cable



Spring



Safety lock



902-344 Economy Grade Cable Cutter



- Rounded blades help keep cable round when it is cut.
- Safety lock for easy storage.
- Built-in return spring and non-slip PVC handles for user comfort.
- Frame made of stamped, hardened carbon steel with curved cutting blade.



Built in return spring, locking latch

Frame made of stamped, hardened carbon steel with curved cutting blade

Soft non-slip PVC handle for a comfortable grip

Model No.	Material	HRC Body	Handle	Application	OAL. (mm/inch)
				Copper cable	
SR-228	S45C	50±2°	PVC	RG-6, RG-58, RG-59 copper clad steel coaxial cable max. 16mm ²	159/6.3
200-015		45±3°	PVC	38mm ² flexible/3AWG	165/6.5
902-344	Carbon steel	45±3°	PVC	Multi-conductor cable up to 0.5"(12.7mm) and stranded wire up to 8AWG(10mm ²)	163/6.4

Individual packing: Blister Card

▶ **200-039** Plastic Pipe Cutter



Ratcheting force-saving design

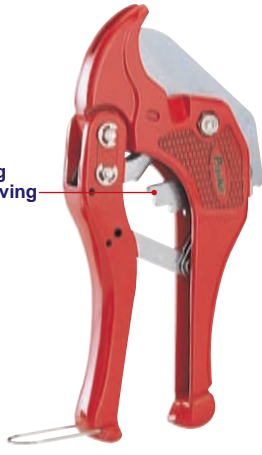

▶ **SR-008** PVC Pipe Cutter (Economy type)

• Ideal for cutting PVC, Aluminum or plastic pipes

BEST Value
Competitive price to market



▶ **200-063** Wire Rope and Armored Cable Cutter



• Special cutting action for cutting wire strand cable armour, electric cable, metal wire and rods.
• Distortion free cut
• Spring loaded handle



Model No.	Material		HRC	Handle	Application	Replacement blade	OAL. (mm/inch)
	Body	Blade					
200-039	Aluminum alloy	SK5	-	PVC	Ø6-42mm/1/4"-5/8" OD. plastic pipes	200-045	195/7.7
SR-008	Aluminum alloy	3Cr13	53±3	PVC	Product characteristics: cuts PVC, Aluminum or plastic pipes. Scope of cut: rigid plastic pipes to a maximum diameter of 26mm	-	210/8.3
200-063	S55C+PVC	SK5	55±3	PVC	Cutting: Ø4mm/6AWG (Copper), Wire rope: Ø1.5mm/14AWG spring wire	-	190/7.5

Individual packing: Blister Card

▶ **200-068/200-013/200-069** Forged Cable Cutter



• This heavy duty cable cutter has high-leverage jaw. with shear-cut blades.
• Do not cut steel or ACSR.
• Plastic coated handle.



Cuts up to 70mm²/00AWG aluminum and copper cables (200-069)

200-068



200-013



200-069



Model No.	Material	HRC		Handle	Application		OAL. (mm/inch)
		Body	Cutting edge		Copper cable		
					Aluminum cable		
200-068	SCM 440	45±3	60±5	PVC	25mm ² flexible/4AWG	25mm ² stranded/4AWG	160/6.3
200-013	SCM 440	45±3	60±5	PVC	38mm ² flexible/3AWG	38mm ² stranded/3AWG	210/8.3
200-069	S45C	45±3	60±5	PVC	16mm ² solid/4AWG, 35mm ² stranded/2AWG, 70mm ² flexible/00AWG	70mm ² stranded/00AWG	235/9.3

Individual packing: Blister Card

SR-538 Ratchet Cable Cutter 750MCM



INDUSTRIAL GRADE

Material: SAE4340
Cutting edge: HRC 46°±2°

Ratchet release trigger

Handle lock

Material: S45C

Material: PP



Cutting cables up to 750MCM (300mm²)

Application	Replacement blade	OAL. (mm/inch)
750MCM(300mm ²) Copper and Aluminum cable	902-258 (Moving blade) 902-259 (Fixed blade)	335/13.2

⚠ Not designed for cutting steel or ACSR Individual packing: Inner box+ color label

200-006 Ratchet Cable Cutter 500MCM



- Cut Ø32mm(1-1/4") and smaller hard-drawn copper and aluminum cables.
- Case hardened blades improve performance and cutting life.
- Unique ratchet design ensures a non-slip cut, and increases cutting power on tough jobs.
- Cut up to 350 MCM copper 500 MCM Al-jacketed S.O. cord up to Ø1-1/4" (Ø32mm) dia or up to 200 Pair Communication cable.



Material		Hardness		Handle	Application	Replacement blade	OAL. (mm/inch)
Body	Blade	Body	Cutting edge				
Low carbon steel	SAE 4340	HR 30N 55~70	HRC 45°±3°	PVC	Ø32mm copper & Aluminum cable	200-034 (Moving blade) 200-035 (Fixed blade)	254/10

⚠ Not designed for cutting steel or ACSR Individual packing: Blister Card

200-043 24" Heavy Duty Cable Cutter



- SCM4 Chrome-Vanadium-Steel forged, efficient and secure in operation.
- Alloy-Aluminum handle, treated by T6 heat, strong durable and handy.

SCM4 Chromium-Molybdenum steel; efficient and secure in operation

Aluminum handles with non-fracture character

Soft rubber sleeves handle

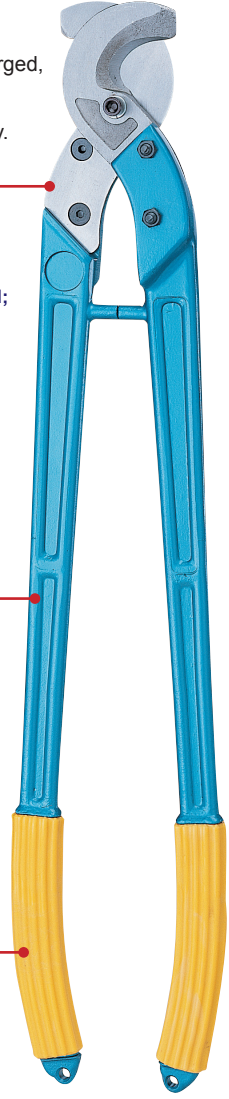

Model No.	Material	HRC	Application	OAL. (mm/inch)	Individual packing
200-043	Blade: SCM4	Blade: 52°±2°	Copper cable: DIN 250mm ² /500MCM	600/23.6	Inner box + Color label

902-062 Ratchet Cable Cutter



Material:SAE 4340
Cutting edge: HRC 45°±3°

- Cutter for cutting for cable up to 750MCM
- Quick release knob for easy blade back out
- Handle locks for convenient tool storage
- For copper and Aluminum Cables only not for cutting Steel
- OAL: 210mm/8.3"

S45C



PP Handle

Replacement blades	
902-258	902-259

Individual packing: Inner box + Color label

KNIVES, SCISSORS & SAWS



▶ 902-318 Utility Knife

- Body is made of durable heavy duty aluminum alloy, corrosion.
- Single screw design for easy blade change.
- Retractable blade with 3 adjustable positions of locking mechanism to prevent injuries.
- Handle with loop design for comfortable use and easy hanging.



Replacement blade:
902-261(100pcs/pack)

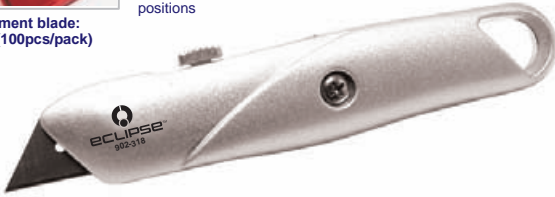

Handle	Blade	OAL.(mm/inch)	Individual packing
Aluminum Alloy	#60 Carbon Steel	155/6.1	Blister card

▶ 902-319 Electrician's Knife



- High quality stainless steel blade construction for extra strength and durability
- Both a heavy duty knife for cutting cable easily and for stripping wires encased in a durable composition handle
- Flathead screwdriver blade with self-locking system for safety.
- Rugged bail hangs onto belt clasp for convenient carrying
- Black composition handle with brass liners, non-slip



Handle	Blade	OAL.(mm/inch)	Individual packing
Steel and Nylon	40Cr	95/3.6	Blister card

▶ 902-317 Carton Cutter

- All metal made cutter and cover for safe usage, equipped with standard replaceable single-side razor blade
- Reverses to become a scraper
- Lightweight and compact design with easy blade change
- Excellent cutter for cutting corrugated, paper, films, acetates, cardboard, and more



Carton cutter



Scraper



Handle	Blade	OAL.(mm/inch)	Individual packing
Stainless Steel	#60 Carbon Steel	101/4	Blister card

▶ DK-2112 Auto Loading Utility Knife



Blade storage compartment

- Comfortable ergonomic shaped handle with non-slip TPR grip
- Automatic blade reload for effortless and quick blade changes
- Convenient blade storage compartment holds up to 6pcs blades (blades included)
- Perfect for cutting carpet, cardboard, upholstery, sheetrock and more.
- 10mm < carpet plastic cardboard PVC leather



Handle	Blade	Replacement blade	OAL. (mm/inch)	Individual packing
Zinc Alloy+TPR	SK5	902-261(100pcs/pack)	165/6.5	Blister card

▶ PD-998 Electrician's Knife



- High quality stainless steel, large curved hawk bill blade offer durability and artistic appearance
- Ideal for heavy-duty line work



PVC, PE cable stripping



Handle	Blade	OAL. (mm/inch)	Individual packing
ABS	3Cr13	110/4.3	Blister card

▶ 900-215 Nibbling Tool

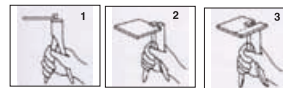

Material to be nibbled shall be placed in the gap between the punch and blade channel.



By squeezing the handle together, the punch will move down into the channel to cut out a slug of metal.



A scribe line can be followed by locking down on work in this position. A slot is cut by making successive cuts.



To make a sharp 90 degrees turn, pull the tool out of the slot, turn the work 90 degrees and insert the tool again.



By turning the tool before each cut, a minimum radius can be cut.



Almost any size or shape hole can be cut by starting with a 3/8"(9.5mm) hole.



Material	HRC	Application	OAL. (mm/inch)	Individual packing
	Body			
Body:FCD45 Blade:S45C	45±3°	Cut up to 18AWG soft steel, 1/16" copper, Al and Plastic	184/7.2	Blister card

PD-395A 30PC Deluxe Hobby Knife Kit



Contents
3pcs TPR+PP dual color non-slip handles
19pcs SK5 carving blades (3pcs in handle)
2pcs awl blades
4pcs shovel blades
1pcs tweezers
1pcs grind stone
Dual color TPR+PP case (8"x5.2"x1.77")

Individual packing: Blister Card



Precision Knife

• Surgically sharp knives with high-impact plastic safety cap.



900-112 Ø8mm



900-113 Ø11mm



900-112B (10pcs/pack) **900-113B** (10pcs/pack)

Model No.	Handle	Blade	Replacement blade	OAL. (mm/inch)	Individual packing
900-112	Aluminum	SK-5	900-112B(10pcs/pack)	145/5.7	Blister card
900-113			900-113B(10pcs/pack)	150/5.9	

902-189 Jab Saw

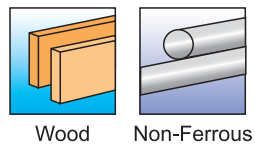
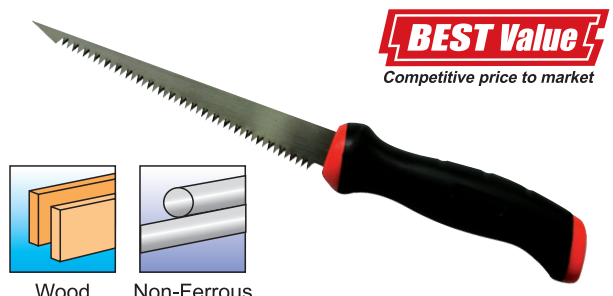

Material		Application	OAL.(mm/inch)	Individual packing
Handle	Blade			
ABS+TPR	65Mn	Wood, plastic and drywall	314/12.5	Blister card

900-135 Cable Splicing Knife

- Short blade for strength
- Stainless-steel blade for durability and longer lasting blade edge
- Soft, easy-to-grip handle

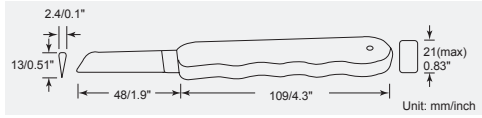

Handle	Blade	OAL.(mm/inch)	Individual packing
TPR	AISI 420	160/6.3	Blister card

900-257 Quick Point Snap-Blade Knife

- Includes 2 pcs blade inside
- Locking slide

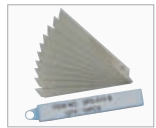

900-257B (10Pcs/Pack)

Economy Grade

Handle	Blade	Replacement blade	OAL.(mm/inch)	Individual packing
ABS	SK-5	900-257B (10Pcs/Pack)	140/5.5	Blister card

900-169 Utility Knife

- All blades are made of high carbon tool steel SK-4
- Blade in thickness: 0.5mm
- includes 3 pcs blade inside

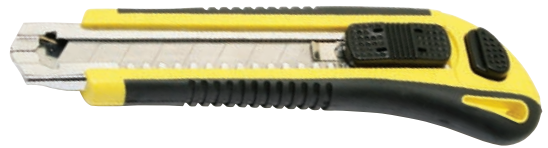

900-169B (6Pcs/Pack)

Handle	Blade	Replacement blade	OAL.(mm/inch)	Individual packing
ABS+TPR	SK-4	900-169B(6Pcs/Pack)	170/6.7	Blister card

902-230 7 in 1 Multi-Function Pocket Tool Key Chain



Be careful: a sharp blade can cut!

Material	HRC	Application	OAL. (mm/inch)	Individual packing
	Body			
2Cr13	48±3°	Serrated Saw, Opener & Slotted Screwdriver, Phillips Screwdriver, Fruit Knife, Mini LED Flashlight	67x32/2.6x1.3	Blister card

▶ **902-083/902-084 All Purpose Snip**



- Cut cable, wire, cloth, carpet, leather, cardboard tin plate, branch, foam rubber and so on.
- Heavy-duty stainless steel blade.
- Dual-color, non-slip handle.



902-083



Leather Aluminum sheet Cable



902-084

Model No.	Material	Handle	Application	OAL. (mm/inch)	Individual packing
902-083	AISI 420	P.P+ T.P.R	Cardboard, PVC Leather, Rubber: thickness < 5mm. Aluminum sheet, Copper sheet: thickness <1mm Steel sheet: thickness < 0.5mm Cable, PVC water pipe, plastic tube up to Ø10mm	165/6.5	Blister card
902-084					

▶ **902-082 All Purpose Snip**



- Ideal for cutting cable, leather, card-board, foam rubber and more.
- Non-slip handle, stainless steel blade and safety lock

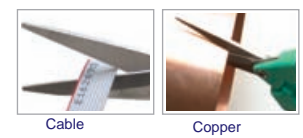

Cable Copper

Material	Handle	Application	OAL. (mm/inch)	Individual packing
AISI 410	P.P+ T.P.R	Cardboard, PVC Leather, Rubber: thickness < 3mm. Aluminum sheet, Copper sheet: thickness <1mm PVC, PET, plastic: thickness <0.2mm Fixable flat cable: thickness <0.3mm	165/6.5	Blister card

▶ **100-035 Fiber Optic Kevlar Cutter**



For cutting Kevlar fiber optic cable



Micro serrated

Material	Handle	OAL. (mm/inch)	Individual packing
High carbon alloy steel	TPR	160/6.3	Blister card

▶ **100-049 Electrician's Scissor**



For use in telephone and electrical service applications.



Scraper and file on side edge of blade.

Material	Handle	Application	OAL. (mm/inch)	Individual packing
AISI 420	Nylon+ Fibber	Stripping from AWG 18 and 22 wire Cutting up to AWG 16 solid wire and AWG 12 stranded wire	145/5.7	Blister card

▶ **SR-333 Micro Scissor**



- Made of stainless steel to resist rust and corrosion.
- Dual color handle provides user comfort
- Return spring offers more smooth operation



Safety cap

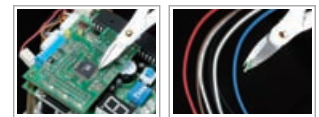

Material	Handle	Application	OAL. (mm/inch)	Individual packing
AISI 420	ABS+ TPE	Cooper, IC, component pin: thickness < 0.3mm. PVC, PET, plastic: thickness <0.2mm Fixable flat cable: thickness <0.3mm	120/4.7	Blister card

CRIMPERS



















All parts of **Pro'sKit** crimping tools are made of special steel, oil-hardened and tempered. They come with ergonomically designed handles and lever action features the optimum transmission of force for fatigue-reduced operation, and high crimping quality due to precision dies and integral ratcheting mechanism.

Pro'sKit crimping tools use interchangeable die sets to crimp a wide variety of different connectors for twisted pair & flat phone cable, fiber optic cable, coaxial cable, electrical and Industrial wire...etc.

Symbols for Crimp die profiles

The **Pro'sKit** crimping dies are made from high precision lost-wax casting technology, providing the high accuracy and long service life!

-  4 pin(RJ22) telephone handset plugs
-  6 pin(RJ11/RJ12) telephone plugs
-  8 pin(RJ45) modular plugs
-  10 pin(RJ50) modular plugs
-  Telecom splice connectors
-  Pin terminal, insulated & non-insulated ferrules
-  Insulated & non-insulated wire ferrules
-  Non-insulated terminals & lugs
-  Open barrel, non-insulated terminals & lugs
-  D-Sub terminal & Non-Insulated Open Barrel Connectors
-  Insulated terminals, Insulated & Uninsulated Flag
-  Insulated terminals
-  RS-232 D-sub round barrel contact pins or sockets
-  Insulated & non-insulated wire ferrules
-  Hex type coaxial connectors & fiber optics connectors
-  Oval type coaxial connectors & fiber optics connectors
-  Square type coaxial connectors center contact pins

Symbols for ratcheting mechanism

Pro'sKit ratcheting crimping tools usually combine crimping pressure adjustment and ratcheting release trigger. The different models have different ratcheting mechanism designs.

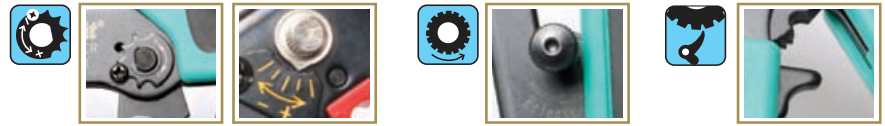



Crimping pressure adjustment

Ratcheting release knob

Symbols for cutting and stripping

Most of **Pro'sKit** modular crimping tools usually feature cutting and stripping functions

-  Cutting wires
-  Stripping flat telephone cables
-  Stripping twisted pair round cables



Ratcheting release trigger



Symbols for force-saving design

Pro'sKit new design of crimping tools designed with lever action, features optimum transmission of force for fatigue-reduced operation and comes with the ratcheting mechanism which helps to ensure the crimping quality. This design requires less force than general hand tools.



Force-saving design



Ratcheting force-saving design

CP-3005F Quick Interchange Ratcheting Crimper Frame



Quick Die Change
without tools



Interchangeable die with quick release trigger

Material: AISI 4140
HRC43'±2'
(Die not included)

Material: S50C
HRC: 45'±3'

Crimping pressure adjustment

Elastomeric resin, double TPR structure.

Ratching release trigger



Special quick release trigger design for easy die changes without extra tools

Material		HRC	OAL (mm/inch)	Individual packing
Body	Handle	Body		
S50C	TPR	45'±3'	226/9.3	Blister card

902-085 CrimPro Crimp Frame



30% force saving
Lever action design



Crimping pressure adjustment wheel

Ratcheting release trigger

Change Dies with thumbscrews.

Elastomeric resin, double structure. non-slip.



Replacement Die Screw 300-056

- Right angled head design prevents awkward wrist bending during operation
- Interchangeable die with thumbscrew

Material		HRC	Replacement Die Screw	OAL (mm/inch)	Individual packing
Body	Handle	Body			
S45C	TPR	45'±3'	300-056	236/9.3	Blister card

We provide a variety of optional dies to meet the most applications, please contact our sales department to discuss custom needs.
All dies on pages 55-57 fit these frame

300-096 Ergo-Lunar Crimp Frame



50% force saving
Lever action design

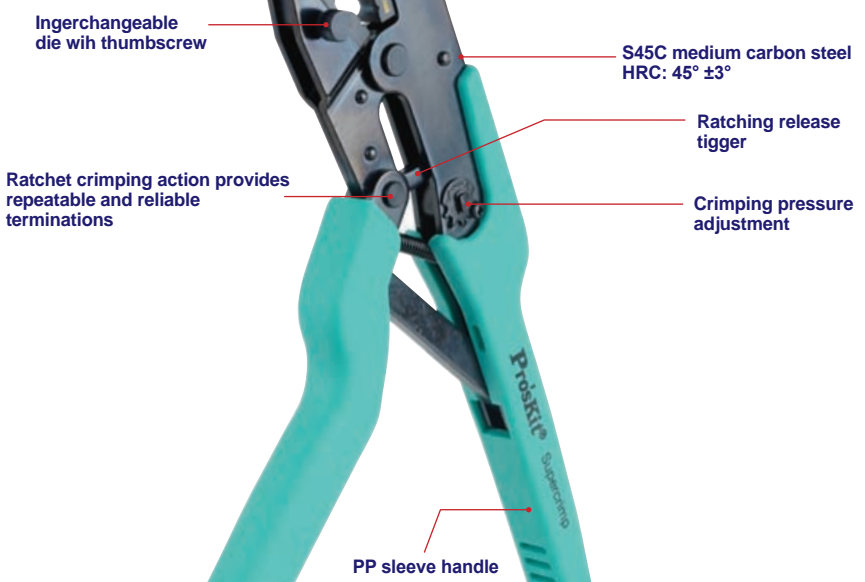

- 40%~50% lower crimping force
- Interchangeable die with thumbscrew

Material		HRC	Replacement Die Screw	OAL (mm/inch)	Individual packing
Body	Handle	Body			
S45C	PP	45°±3°	300-056	260/10.2	Blister card



Replacement Die Screw 300-056

300-054 Lunar Crimp Frame



Compact size
for easy operation



Material		HRC	Replacement Die Screw	OAL (mm/inch)	Individual packing
Body	Handle	Body			
S45C	PP+TPR	45°±3°	300-056	220/8.6	Blister card



Replacement Die Screw 300-056

We provide a variety of optional dies to meet the most applications, please contact our sales department to discuss custom needs. All dies on pages 55-57 fit these frame



300-096
Ergo-Lunar
Crimp Frame



300-054
Lunar
Crimp Frame



902-085
CrimPro Crimp
Frame



CP-3005F
Quick Interchange
Ratcheting Crimper
Frame

Note: CP-3005F sold as frame only, but all dies on this page fit it

DIE Set	Crimp die profile	Application	Crimp Size	Terminals	Description	Model No.
Coaxial Connectors						
		RG8/11/174/179/213	HEX: .100", .128"/.429" HEX: 2.54, 3.25, 10.90mm		Lunar frame w/die Ergo-Lunar frame w/die CrimPro frame w/die Die only	902-536 902-537 902-538 902-518
		Amphenol and General RG58, RG59, RG62, BNC/TNC, F-Type, LMR-240	SQ .052", HEX.068", .100", .197", .255" SQ1.32, HEX1.73, 2.54, 5.41, 6.48mm		Lunar frame w/die Ergo-Lunar frame w/die CrimPro frame w/die Die only	902-277 902-278 902-279 902-201
		HDTV, SMA, True 75-ohm BNC/TNC & mini-UHF, RG174, RG59/62, mini-coaxial & Belden 1855A	SQ .042", HEX.068", .178", .197", .255" SQ 1.07mm, HEX1.73, 4.52, 5.00, 6.48mm		Lunar frame w/die Ergo-Lunar frame w/die CrimPro frame w/die Die only	300-187 300-188 300-189 1PK-3003D34
		RG58, 59 and 62 AU, BNC and TNC 3-piece connectors	HEX.068", .213", .256" HEX1.73, 5.41, 6.5mm		Lunar frame w/die Ergo-Lunar frame w/die CrimPro frame w/die Die only	300-019 300-109 902-143 300-045
		HDTV BNC/TNC 3-piece coaxial connectors	SQ .042", HEX.178", .275" SQ 1.07mm, HEX4.52, 6.99mm		Lunar frame w/die Ergo-Lunar frame w/die CrimPro frame w/die Die only	300-184 300-185 300-186 1PK-3003D33
		HDTV true 75-ohm BNC/TNC coaxial connectors: Belden 1855A, 1865A, 1505A, 1505F, 1694A, 1694F	HEX .041", .068", .178", .255", .278" SQ1.04, HEX1.73, 4.52, 6.48, 7.06mm		Lunar frame w/die Ergo-Lunar frame w/die CrimPro frame w/die Die only	300-158 300-159 902-171 300-157
		HDTV BNC/TNC 3-piece coaxial connectors	SQ .042", Hex. 197", .278" SQ1.07mm, HEX 5.00, 7.06mm		Lunar frame w/die Ergo-Lunar frame w/die CrimPro frame w/die Die only	300-193 300-194 300-195 1PK-3003D30
		HDTV BNC/TNC true 75-ohm coaxial connectors, RG6, Belden 1694 & 1694A	SQ.042", HEX.068", .275", .278" SQ1.07mm, HEX1.73, 6.99, 7.06mm		Lunar frame w/die Ergo-Lunar frame w/die CrimPro frame w/die Die only	300-178 300-179 300-180 1PK-3003D31
		BNC, TNC, Mini-UHF, RG58, 141, 142, 303, 400, 59, 62, 210 Belden 8279, 8281, 9231, 9141 RG-6, 212, 222, 304	HEX.068", .098", .213", .255", .321" HEX1.73, 2.49, 5.41, 6.48, 8.15mm		Lunar frame w/die Ergo-Lunar frame w/die CrimPro frame w/die Die only	300-003 300-119 902-137 300-038
		RG59 and Belden 8281/1694A cable groups for both 50 & 75 ohm center pins	HEX.042", .068", .255", .324" HEX1.07, 1.73, 6.48, 8.23mm		Lunar frame w/die Ergo-Lunar frame w/die CrimPro frame w/die Die only	300-022 300-116 902-146 300-048
		HDTV true 75 ohm BNC/TNC & CATV "F" coaxial connectors, RG59, RG6, Belden 8281, 1694A & 1505A	SQ .042", .052", HEX .068", .255", .324" SQ 1.07, 1.32mm, HEX1.73, 6.48, 8.23mm		Lunar frame w/die Ergo-Lunar frame w/die CrimPro frame w/die Die only	300-181 300-182 300-183 1PK-3003D32
		CATV "F" connectors RG-59, RG-6 and RG-6 Quad	HEX.255", .320", .350" HEX6.48, 8.13, 8.89mm		Lunar frame w/die Ergo-Lunar frame w/die CrimPro frame w/die Die only	300-007 300-112 902-139 300-041
		RG8, RG11, RG213, RG216 BNC, TNC and N Series Connectors LMR400	HEX.80", .100", .429" HEX2.03, 2.54, 10.90mm		Lunar frame w/die Ergo-Lunar frame w/die CrimPro frame w/die Die only	300-023 300-117 902-147 300-049
		Crimps Amphenol connectors. Coaxial - Belden 7810A, 9913, 9914, LMR 400.	HEX .429", .118" HEX10.89, 3.00mm		Lunar frame w/die Ergo-Lunar frame w/die CrimPro frame w/die Die only	300-163 300-168 300-173 9PK-3003D29
		Combi-Die for RJ45 WE/SS Modular plugs and RG6/6Q(CATV F-Type)	RJ45 plug HEX.324", .360" HEX 8.23, 9.14mm		Lunar frame w/die Ergo-Lunar frame w/die CrimPro frame w/die Die only	300-161 300-162 902-172 902-054



300-096
Ergo-Lunar
Crimp Frame



300-054
Lunar
Crimp Frame



902-085
CrimPro Crimp
Frame



CP-3005F
Quick Interchange
Ratcheting Crimper
Frame

Note: CP-3005F sold as frame only, but all dies on this page fit it

DIE Set	Crimp die profile	Application	Crimp Size	Terminals	Description	Model No.
Fiber Optic Connectors						
		RG174, RG179 Belden 8218, fiber optics.	SQ.042", HEX.068", .078", .128", .151", .178" SQ1.07, HEX1.73, 1.98, 3.25, 3.84, 4.52mm		Lunar frame w/die	300-024
					Ergo-Lunar frame w/die	300-118
					CrimPro frame w/die	902-148
					Die only	300-050
		For FC, SC, ST, LC, SMA & MT-RJ fiber optics.	HEX .139", .151", .178", RD.134", .190" HEX3.53, 3.84, 4.52mm, RD3.40, 4.83mm		Lunar frame w/die	300-167
					Ergo-Lunar frame w/die	300-172
					CrimPro frame w/die	300-177
					Die only	9CP-336DF4
		SMA, SMB, FC Biconic and SC & ST fiber optic connectors, RG58, RG174, Belden 8218	SQ.042", HEX.068", .151", .178", .213" SQ1.07, HEX1.73, 3.84, 4.52, 5.41mm		Lunar frame w/die	300-021
					Ergo-Lunar frame w/die	300-115
					CrimPro frame w/die	902-145
					Die only	300-047
		Fiber Optic and Coaxial SMA/SMB/SFR Connectors SC/ST/FC	HEX.151", .178", .213" HEX3.84, 4.52, 5.41mm		Lunar frame w/die	300-106
					Ergo-Lunar frame w/die	300-143
					CrimPro frame w/die	902-167
					Die only	300-102
Electrical and Industrial Terminals						
		Miniature Insulated Terminals Nylon and Vinyl	AWG26-16 DIN 0.2-1.5mm ²		Lunar frame w/die	300-146
					Ergo-Lunar frame w/die	300-147
					CrimPro frame w/die	902-169
					Die only	300-104
		Red, Yellow, Blue Insulated terminals Nylon and Vinyl	AWG22-18/16-14/12-10 DIN 0.5-1.0/1.5-2.5/4.0-6.0mm ²		Lunar frame w/die	300-002
					Ergo-Lunar frame w/die	300-108
					CrimPro frame w/die	902-152
					Die only	300-058
		Thin Style Insulated Terminals (red/yellow/blue) Nylon and Vinyl	AWG22-18/16-14/12-10 DIN 0.5-1.0/1.5-2.5/4.0-6.0mm ²		Lunar frame w/die	300-141
					Ergo-Lunar frame w/die	300-142
					CrimPro frame w/die	902-166
					Die only	300-101
		Insulated Terminals	AWG22-18/16-14/12-10/8 DIN 0.5-1.0/1.5-2.5/4.0-6.0/10.0mm ²		Lunar frame w/die	CP-336FD27
					Ergo-Lunar frame w/die	1PK-3003FD27
					CrimPro frame w/die	CP-372FD27
					Die only	9PK-3003D27
		Uninsulated Terminals	AWG20-18/16-14/12-10/8 DIN 0.5-1.0/1.5-2.5/4.0-6.0/10.0mm ²		Lunar frame w/die	300-132
					Ergo-Lunar frame w/die	300-133
					CrimPro frame w/die	902-161
					Die only	300-095
		Open Barrel Contacts Molex/Tyco D-Sub, Molex, AMP Style Pin	AWG30-24/22-18 DIN 0.05-0.25/0.5-1.0mm ²		Lunar frame w/die	300-164
					Ergo-Lunar frame w/die	300-169
					CrimPro frame w/die	300-174
					Die only	9PK-3003D36
		Open barrel contacts D-sub, Molex, AMP style pin	AWG20-18/16-14/12-10 DIN 0.5-1.0/1.5-2.5/4.0-6.0mm ²		Lunar frame w/die	300-005
					Ergo-Lunar frame w/die	300-120
					CrimPro frame w/die	902-138
					Die only	300-039
		For Red and Blue Insulated Flag Terminals AWG 22-18, 16-14	AWG22-18/16-14 DIN 0.5-1.0/1.5-2.5mm ²		Lunar frame w/die	300-072
					Ergo-Lunar frame w/die	300-130
					CrimPro frame w/die	902-158
					Die only	300-070
		For Yellow and Blue insulated Flag Terminals	AWG16-14/12-10 DIN 1.5-2.5/4.0-6.0mm ²		Lunar frame w/die	902-332
					Ergo-Lunar frame w/die	902-331
					CrimPro frame w/die	902-330
					Die only	9PK-3003D42
		Uninsulated Flag Terminals	AWG22-18/16-14 DIN 0.5-1.0/1.5-2.5mm ²		Lunar frame w/die	300-073
					Ergo-Lunar frame w/die	300-131
					CrimPro frame w/die	902-159
					Die only	300-071



300-096
Ergo-Lunar
Crimp Frame



300-054
Lunar
Crimp Frame



902-085
CrimPro Crimp
Frame



CP-3005F
Quick Interchange
Ratcheting Crimper
Frame

Note: CP-3005F sold as frame only, but all dies on this page fit it

DIE Set	Crimp die profile	Application	Crimp Size	Terminals	Description	Model No.
Electrical and Industrial Terminals						
		Wire ferrules (Insulated and Non-Insulated)	AWG22/20/18/16/14/12 DIN 0.5/0.75/1.0/1.5/2.5/ 4.0mm ²		Lunar frame w/die Ergo-Lunar frame w/die CrimPro frame w/die Die only	300-001 300-134 902-162 300-097
		Wire Ferrules (Insulated and Non-Insulated)	AWG10/8/6 DIN 6/10/16mm ²		Lunar frame w/die Ergo-Lunar frame w/die CrimPro frame w/die Die only	300-144 300-145 902-168 300-103
		Wire Ferrules (Insulated and Non-Insulated)	AWG6/4/2 DIN 16/25/35mm ²		Lunar frame w/die Ergo-Lunar frame w/die CrimPro frame w/die Die only	300-077 300-160 902-160 300-077D
		Spark Plug Cable-Cut, Strip, Crimp	8-8.5mm Spark plug wires		Ergo-Lunar frame w/die CrimPro frame w/die Die only	902-275 902-276 9PK-3003D26
Solar Terminals						
		Multi-Contact (MC3)Ø3mm solar contacts	AWG14/12/10 DIN 2.5/4.0/6.0mm ²		Lunar frame w/die Ergo-Lunar frame w/die CrimPro frame w/die Die only	300-165 300-170 300-175 CP-5S1D
		Multi-Contact (MC4)Ø4mm solar contacts	AWG14/12/10 DIN 2.5/4.0/6.0mm ²		Lunar frame w/die Ergo-Lunar frame w/die CrimPro frame w/die Die only	300-166 300-171 300-176 CP-5S2D

Solar Series Crimpers



Material	OAL (mm/inch)	Individual packing
S45C	203/8.12	Blister card

DIE Set	Crimp die profile	Application	Description	Model No.
		D-Subminiature contacts, RS232 pins & sockets AWG 30-18 Open Barrel contacts (Molex/AMP style)	Completed set with die Die only Frame only	300-009 300-086 300-087
		Wire Ferrules AWG 22-10	Completed set with die Die only Frame only	300-010 300-105 300-087

902-337 PowerPole® Crimper



Phillips long screw that holds the locator in place



PowerPole® is a registered trademark of Anderson Power products

Material	Application	OAL (mm/inch)	Individual packing
S45C	PowerPole® modular connector #15(20~16 AWG/0.5~1.0mm ²) #30(16~12 AWG/1.0~2.5mm ²) #45(14~10 AWG/1.5~4.0mm ²)	260/10.2	Blister card

CP-3006F Parallel Action Crimping Tool



Features:

- **Reliable:** Parallel action crimping performance is consistent and accurate
- **Practical:** Safety crimp release helps eliminate rejected terminations due to incorrect positioning.
- **Comfortable:** Ergonomically shaped non-slip TPR handle for comfortable use in all conditions
- **Versatile:** Interchangeable die sets for wide range of applications.

Special design perfect fit for open barrel terminal and solar connectors



Material		HRC	OAL. (mm/inch)	Individual packing
Body	Handle			
S50C	TPR	45°±3°	254/10	Blister card

Model No.	Replacement Die model no.	DIE Set	Crimp die profile	Application	Terminals
CP-3006F				Frame only	
CP-3006FD2	300-039			Non insulated open barrel connectors, commercial type AWG 22-18/16-14/12-10 DIN 0.5-1.0/1.5-2.5/4.0-6.0 mm ² JIS 0.35-0.9/1.25-2.0/3.5-5.5 mm ²	
CP-3006FD36	9PK-3003D36			Non-insulated open barrel connectors & D-SUB V.35 contact pins AWG 30-24/22-18 DIN 0.05-0.25/0.50-1.0 mm ² JIS 0.05-0.25/0.35-0.9 mm ²	
CP-3006FS1	CP-5S1D			For MC 3 solar connector (Multi-Contact) & 2.5/4.0/6.0 mm ² (AWG 14/12/10) solar cable AWG 14/12/10 DIN 2.5/4.0/6.0 mm ²	
CP-3006FS2	CP-5S2D			For MC 4 solar connector (Multi-Contact) & 2.5/4.0/6.0 mm ² (AWG 14/12/10) solar cable AWG 14/12/10 DIN 2.5/4.0/6.0 mm ²	

902-520 Crimper with Weatherpack Die



Special design to be used with weatherpack weathertight connectors

- **Reliable:** Parallel action crimping performance is consistent and accurate
- **Practical:** Safety crimp release helps eliminate rejected terminations due to incorrect positioning.
- **Comfortable:** Ergonomically shaped non-slip TPR handle for comfortable use in all conditions
- **Versatile:** Interchangeable die sets for wide range of applications.

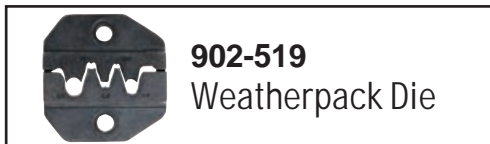
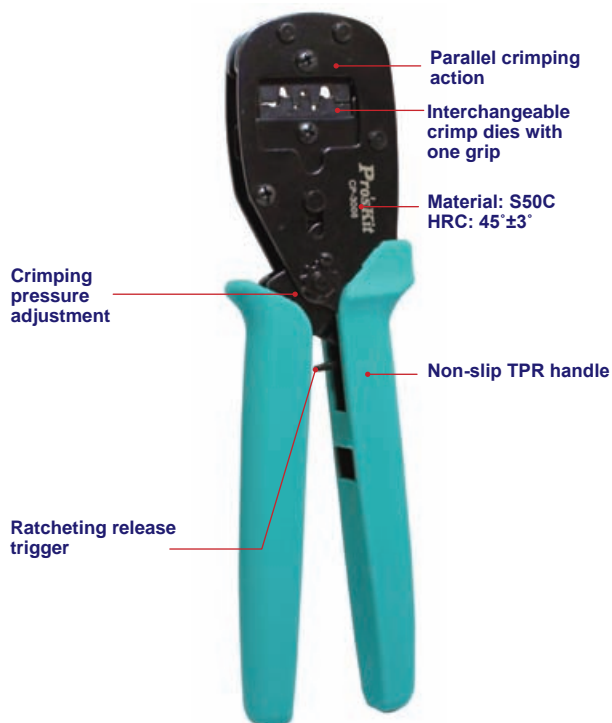

Material		HRC	OAL. (mm/inch)	Individual packing
Body	Handle			
S50C	TPR	45°±3°	254/10	Blister card

Model No.	Description	Crimp die profile	Application	Terminals
902-519	Die only		Weather Pack Terminals & Seals Crimp size : AWG 14-16/18-20/22-24	
902-520	Crimper with Weatherpack Die			

PK-2061 Solar MC3 & MC4 Crimping Tool Kit



This is a complete tool kit to install MC3 & MC4 solar connectors easily and accurately.



11"x7.8"x2.8"

To open the locking device
To secure

To tighten the cable gland

Includes 2 pcs MC4 and MC4 PLUS open-end spanner and unlocking tool help you opening the locking device, securing and tightening the cable gland.

Universal solar cable stripper comes with adjustable length stop for reliable stripping of the double layer insulated cables (2.5 - 6.0 mm²)

The Parallel action crimper features consistent and accurate performance

Heavy duty Forged Cable Cutter with high leverage Jaw and shear blade for clean cut without damage.

Prosoft screwdrivers for PV junction box installation

Contents:

Parallel Action Crimper frame
Die set for MC 3 solar connector (Multi-Contact) & 2.5/4/6m ² (AWG 14/12/10) solar cable.
Die set for MC 4 solar connector (Multi-Contact) & 2.5/4/6m ² (AWG 14/12/10) solar cable.
Universal solar cable stripper, for 2.5/4/6m ² (AWG 14/12/10) solar cable
Forging cable cutter (160mm), for copper cable: 25mm ² flexible
2 Pcs Open-end spanner and unlocking tool (MC4 and MC4 PLUS)
Pro-soft screwdriver 5x75mm
Pro-soft screwdriver #2 x100mm
Zipper carrying bag-280x197x70(mm)/11"x7.8"x2.8"

Professional Modular Crimps Strips & Cuts Tool



For AMP style connectors only

- For crimping modular plugs in parallel action.
- Cuts, strips, and crimps modular plugs without changing modular (DIE) set.



300-064



10P 10C, AMP 8P8C/RJ-45 only



Stripping twisted pair round cable



CP-376K



Model No.	Material	Handle	HRC	Application	Replacement blade	O.A.L (mm/inch)	Individual packing
300-064	S45C	Black:T.P.R Green:PP	45 ±3°	10P10C, AMP 8P8C/RJ45, 6P6C/RJ12, 6P4C/RJ11, 4P4C & 4P2C/RJ22 plugs, and DEC/Offset 6P6C plugs	5PK-376K-BLADE (6pcs/pack)	205/8.1	Blister card
CP-376K				8P8C/RJ-45, 6P6C/RJ11, 4P4C & 4P2C/RJ22 plugs, and RJ11/6P6C DEC-Offset plugs	5PK-376K-BLADE (6pcs/pack)	205/8.1	

300-004 4P/6P/8P Telecom Crimping Tool



902-360 Ratcheted Modular Plug Crimper



Economy Grade



Model No.	Material	Handle	HRC	Application	Replacement blade	O.A.L (mm/inch)	Individual packing
300-004	S45C	Black:T.P.R Green:PP	45°±3°	8P8C/RJ45, 6P2C/6P4C/6P6C RJ11 modular plugs, RJ-22 4P2C/4P4C handset modular plugs	300-004B (6Pcs/pack)	190/7.5	Blister card
902-360	Carbon steel	PP/TPR	45°±3°	Application for 4/6/8P modular connector	-	190/7.5	Blister card

Modular Crimping Tool

CP-376M



300-063



Model No.	Material	Handle	HRC	Application	Replacement blade	O.A.L(mm/inch)	Individual packing
CP-376M	S45C	Black:T.P.R Green:PP	HV 555~650°	8P8C/RJ45, 6P2C/6P4C/6P6C RJ11 modular plugs, RJ-22 4P2C/4P4C handset modular plugs	900-078 (2pcs/pack)	225/8.9	Blister card
300-063	S45C	Black:T.P.R Green:PP	HV 555~650°	8P8C/RJ45, 6P2C/6P4C/6P6C RJ11 modular plugs	900-078 (2pcs/pack)	216/8.5	Blister card

CP-333 Modular Plug Crimping Tool



Nwe mechanism force saving



902-086 Pro-Crimper Modular Tool



Material		Application	OAL (mm/inch)	Individual packing
Handle	Body			
PVC coated	ABS + Carbon Steel	For stripping UTP/STP cable and cutting function For crimping RJ-45 (8P8C), RJ-11/12(6P6C/6P4C/6P2C) modular plugs	143/5.6	Blister card

Material	Application	Replacement blade	O.A.L (mm/inch)	Individual packing
ABS + carbon steel	8P8C/RJ45, 6P2C/6P4C/6P6C RJ11 modular plugs, RJ-22 4P2C/4P4C handset modular plugs	300-004B (6Pcs/pack)	160/6.3	Blister card

▶ **300-018 Modular Crimping Tool**



Lock for easy storage

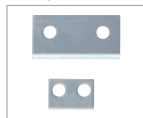

5CP-376E-B (2pcs/pack)

▶ **300-028 Economy All-In-One Modular Plug Crimper**

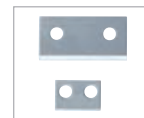

200-053 (2pcs/pack)

Model No.	Material	Handle	HRC	Application	Replacement blade	O.A.L.(mm/inch)	Individual packing
300-018	Low carbon steel	PP	45±3°	8P8C/RJ45, 6P2C/6P4C/6P6C RJ11 modular plugs	5CP-376E-B (2pcs/pack)	200/7.9	Blister card
300-028	S45C	PP	45±3°	8P8C/RJ45, 6P2C/6P4C/6P6C RJ11, DEC/MMJ modular plugs	200-053 (2pcs/pack)	200/7.9	Blister card

▶ **300-088/300-089/300-090 Modular Crimping Tool**

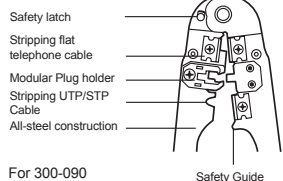

300-004B(6pcs/pack)



300-088

4-pin



300-089

6-pin



300-090

8-pin

Model No.	Material	Handle	HRC	Application	Replacement blade	O.A.L. (mm/inch)	Individual packing
300-088	Low carbon steel	Black:T.P.R	45±3°	RJ22 4P2C/4P4C handset modular plugs	900-117(6pcs/pack)	205/8.1	Blister card
300-089		Green:PP		6P2C/6P4C/6P6C RJ11/RJ12 modular plugs	900-117(6pcs/pack)	205/8.1	
300-090				8P8C RJ45 modular plugs	300-004B(6pcs/pack)	190/7.5	

▶ **100-008 Telecom Splice Crimp Tool**



- Designed for UG, UR and UY connectors.
- A special stop behind cutout prevents connectors from damage.



Application	Crimp Size	O.A.L. (mm/inch)	Individual packing
UR / UY / UG connectors	Solid copper wire UR:19 to 26 AWG UY:22 to 26 AWG UG:19 to 26 AWG	150/5.9	Blister card

▶ **CP-148 Cutter/Stripper & Crimper**



- Stripper:0.8 and 1.4mm stripping holes for AWG 24/22 &20/18/16
- Pliers:Long nose design for easy wire bending, pulling and holding
- Cutter:Steel body with black oxide finish
- Crimper:For UR/UY/UG,AMP tel splice connector,709 series connectors



Stripper



Cutter



Crimper



Plier

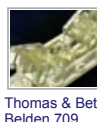

Thomas & Betts/Belden 709 connectors



AMP tel splice connectors



3M Scotchlok UR/UY/UG tel splice connectors



Material		HRC		OAL. (mm/inch)	Individual packing
Body	Handle	Body	Cutting edge		
S55C	PVC	46°-48°	55°-65°	168/6.6	Blister card

CP-418
Copper Clad Steel Coaxial Cable Crimper



- All in one design-For cutting & stripping & crimping RG6 and RG59 coaxial cable.
- Strips coaxial cable-
By 2 steps for outer jacket at 1/4" & center core at 1/4" or 5/16".
- Precision stripping hole-
For removing inner dielectric insulation without damaging the center conductor.

Stripping length guide

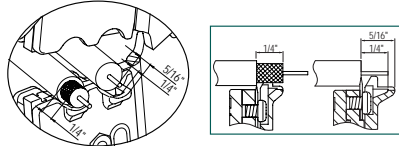

Material		Application	OAL.(mm/inch)	Individual packing
Body	Handle			
S45C	PVC	RG6, RG59	207.5/8.5	Blister card

300-074 "F" Type Crimper



Material	Handle	HRC	Application	O.A.L (mm/inch)	Individual packing
S45C DIE: AISI 4140	PP	46 ±3°	RG59, 6, 62 Cables and CATV Connectors, HEX: .322", .255"	225/9	Blister card

902-087 Fiber Optic Crimping Tool

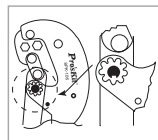

Adjustable Disc

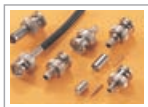

902-270 Heavy Duty Coaxial Crimping Tool

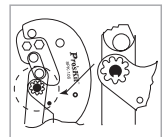

Adjustable Disc



Model No.	Material	Handle	HRC	Application	O.A.L.(mm/inch)	Individual packing
902-087	S45C DIE: AISI 4140	PP	45 ±3°	SC & ST fiber optic connectors HEX .122", .133", .151", .188" HEX 3.10, 3.38, 3.84, 4.78mm	240/9.4	Blister card
902-270	S45C DIE: AISI 4140	PP	45 ±3°	RG58, RG59, 6, 11 & UHF-58, 8 Cables and BNC, TNC Connectors HEX: .100", .359", .406	225/9	Blister card

▶ 300-092 Plier Style Economy Crimper

- For RG59/62/6 and F-connectors



Material	Handle	HRC	Application	O.A.L (mm/inch)	Individual packing
Carbon steel	PVC	45°±3°	RG59/62, 6 hex type, F connector	200/8	Blister card

▶ 300-149 Crimper Wire Ferrules



Self-Adjusting



Material	Handle	HRC	Application	O.A.L (mm/inch)	Individual packing
S45C	PP	45°±3°	For Insulated and Non-Insulated Wire Ferrules and AWG20-12 wire	205/8.1	Blister card

▶ CP-316 Adjustable Compression Tool



- For crimping waterproof connector F, BNC, RCA, IEC, MINI F on RG58, RG59, RG6 coaxial cable.
- Has body scale to easily adjust plunger from 21 to 46mm.
- Comes with integrated handle lock for easy storage.
- Steel body with black oxide finish.



RCA waterproof connectors BNC waterproof connectors F waterproof connectors Mini F connectors IEC connectors

Material		Hardness of main parts	Application	OAL (mm/inch)	Individual packing
Handle	Body				
ABS	S50C	HR15N 75-79°	For crimping connector F, BNC, RCA, IEC, MINI F coaxial cables	146/5.7	Blister card

▶ CP-315 Adjustable Compression Tool



Model No.	Material	Handle	HRC	Application	O.A.L (mm/inch)	Individual packing
CP-315	Carbon steel	Nylon	40°±5°	Connecting waterproof connectors F, BNC, RCA on RG-58, RG-59 and RG-6 coaxial cables	120/4.7	Blister card
CP-313	Carbon steel	PVC	40°±5°	RG-58, 59, 6(3C, 4C, 5C), F / BNC / RCA Connectors	152/6.0	Blister card

▶ 902-245 Compression Connector Crimping TOOL



Material	Handle	HRC	Application	O.A.L (mm/inch)	Individual packing
Carbon steel+ABS	PVC	40°±5°	RG-58, 59, 6 / F Connector	143/5.6	Blister card

▶ CP-313 Adjustable Compression Crimping Tool



▶ 300-091 Compression Connector Crimping Tool



• For RG-58, RG-59, RG-6 and F connectors.

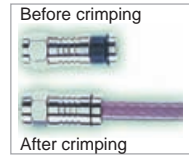

Material	Handle	HRC	Application	O.A.L (mm/inch)	Individual packing
S45C	PVC	45°±3°	RG-58, 59,6 (3C, 4C, 5C), F Connectors	215/8.5	Blister card

▶ 300-011 IDC Crimp Tool



• For crimping IDC-type of connectors onto flat cables

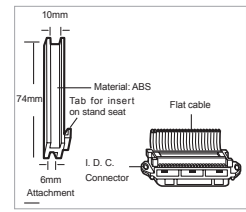

Material	Handle	HRC	Application	O.A.L (mm/inch)	Individual packing
Low carbon DIE:ABS Handle:PP	PVC	45°±3°	IDC-type connectors Height: 6mm~27.5mm Width(Max): 55mm	240/9.4	Blister card

▶ 300-075 D-Sub, 2-Stage, Open Barrel Crimper



Model No.	Material	Handle	HRC	Application	O.A.L (mm/inch)	Individual packing
300-075	Carbon steel	Cushion	45°±3°	For crimping D-Sub AWG.20/24/28	175/6.9	Blister card

▶ 300-035 Multi-Purpose Crimper



Model No.	Material	Handle	HRC	Application	O.A.L (mm/inch)	Individual packing
300-035	Carbon steel	Cushion	45°±3°	For computer pins & sockets, D-Sub 26-28 AWG wire, For butt-insulated connectors, 22-26 AWG wire, For telephone piercing spade lugs, 22-26 AWG wire. For open barrel connectors, 20-22 AWG wire, For open barrel connectors, 14-18 AWG wire, For non-insulated terminals, 10-14,16-18 and 20-22 AWG wire	185/7.3	Blister card

▶ CP-416 Cutter/Stripper & Crimper Insulated and Non-Insulated Wire Ferrules



3 in 1

- Features:**
- All in one combination for crimping, stripping and cutting.
 - Made of high quality carbon steel with black oxide finished for anti-rust.
 - PVC cushion grip handle provides user comfort.
 - The stripper is processed by CNC lathe to ensure the accuracy.

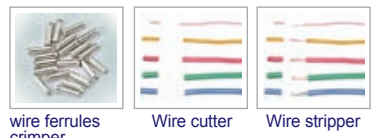

Material	Handle	HRC	Application	O.A.L (mm/inch)	Individual packing
DIE: 4140 Frame: S45C	PVC	DIE:42°±2° Frame: 44°±2°	Crimping, Wire Ferrules 0.25~2.5 mm ² , Stripping wire AWG 26~14	200/8	Blister card

▶ 902-088 Multi-Purpose Crimping Tool



Material	Hardness	Handle	Application			O.A.L (mm/inch)	Individual packing
			Strip	Cutter	Crimp		
S45C	HRC: 45°±3°	PVC	10, 12, 14, 16, 18, 20, 22, AWG	Bolt cutter: 4-40, 5-40, 6-32, 8-32, 10-32, 10-24	Insulation & Non-insulation: 10~16, 18~22AWG	210/8.3	Blister card

▶ 300-079 Wire Ferrule Crimp Tool-Square Crimp

- DESCRIPTION: Ratcheted, AWG 28-7 wire ferrules
- APPLICATION: For crimping all wire ferrules insulated and non-insulated (AWG 28-7). Produces square crimp cross section. Made in Germany.
- PACKAGING: Blister Card

PROFESSIONAL



Material		Application	O.A.L. (inch)	Individual packing
Body	Handle			
58CrV4 Steel	TPR	For crimping all wire ferrules insulated and non-insulated (AWG 28-7)	7	Blister card

▶ 300-015 4 Way Indent Crimping Tool



Features

- Used to crimp closed barrel, screw machine pin and socket style contacts.
- Performs a simultaneous 4 indent crimp for superior contact retention.

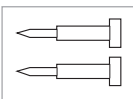

4 Way to Crimping



Material	HRC	Handle	Application	O.A.L. (mm/inch)	Individual packing
S50C	45°±3°	PVC	Crimping of closed-barrel RS-232 D-sub contacts. AWG 26-20, DIN 0.2-0.5 mm², JIS 0.2-0.5 mm²	162 /6.4	Blister card

▶ 300-016 Precision Crimping Tool With Wire Ferrules



Including wire ferrules

- 0.5 x 6mm: 40pcs
- 0.75 x 6mm: 40pcs
- 1.0 x 6mm: 30pcs
- 1.5 x 7mm: 20pcs
- 2.5 x 7mm: 20pcs



Terminal crimper



Material	Handle	HRC	Application	O.A.L. (mm/inch)	Individual packing
S45C	PVC	45°±3°	Non-insulated wire ferrules AWG 23/22/20/18/17/15/13, 0.25/ 0.34/0.5/ 0.75/1.0/1.5/2.5mm²	160/6.3	Blister card

▶ CP-462G Wire Ferrule Crimp Tool-Square Crimp



Features:

- Adjustable ratchet and lever action construction reduces fatigue degree.
- Special four-mandrel crimping style for square crimp.
- High quality crimping standard ensures repeatable crimping action.

Economy Grade



Four-mandrel for square crimp



Material	HRC	Handle	Application	O.A.L. (mm/inch)	Individual packing
S44C	40°±2°	Nylon	Usable for cord end terminals AWG 26 ~ 10, DIN 0.25 ~ 6.0 mm² JIS 0.20 ~ 5.5 mm²	175/6.9	Blister card

▶ CP-463 D-Sub Contact Crimping Tool



Features

- Ergonomic handle design provides low-effort operation
- Superior pull strength results
- High quality crimping standard ensures repetitive, reliable crimping action
- Adjustable pin height locator

For Larger Wire Size

4 Way to Crimping



Material	HRC	Handle	Application	O.A.L. (mm/inch)	Individual packing
SPCC + carbon steel	45°±3°	PVC	Crimping of closed-barrel RS-232 D-sub contacts. AWG 20-12 / DIN 0.5-4.0 mm² JIS 0.5-3.5 mm²	165/6.5	Blister card

▶ 902-499 4-Way Indent Crimper-Deutsch



Ideal for crimping deutsch closed barrel terminals found on motorcycles, trucks and other heavy duty vehicles.



For use with 16-20AWG closed barrel terminals.



Material		HRC		OAL (mm/inch)	Individual packing
Body	Handle	Body	Cutting edge		
S55C	PVC	44°±1°	55°-65°	163/6.4	Blister card

▶ CP-412G/CP-413G Heavy Duty Wire Strippers/Crimpers

CP-412G

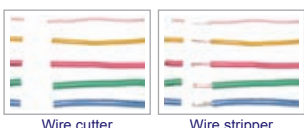

Wire cutter

Wire stripper



Bolt cutter



Crimp insulated and non-insulated Terminals

CP-413G



Model No.	Material	Handle	HRC	Application			O.A.L. (mm/inch)	Individual packing
				Wire strip	Bolt cutter	Crimp		
CP-412G	S50C	PVC	45 ±3°	Stranded wire: 12-24AWG Solid wire: 10-24AWG	4-40, 8-32, 6-32, 10-32, 10-24	10-22 AWG (Barrel-type insulated and Non-Insulated terminal)	206/8.1	Blister card
CP-413G	S50C	PVC	45 ±3°	Stranded Wire: 26-24, 22-20, 18, 16, 14, 12, 10 AWG Solid Wire: 22-20, 18, 16, 14, 12, 10, 8 AWG	4-40, 10-32, 10-24, 8-32, 6-32	26-14, 12-10 AWG (Insulated Terminal) 22-10 AWG (Non-Insulated Terminal)	215/8.5	Blister card

▶ CP-386 Snap Plier

- Ergonomic and light weight design for less fatigue, save effort up to 65%.
- Die set contains both male stud & eyelet and female cap & socket snaps.



Accessories:
Hex wrench and die set



Material		Application	O.A.L. (mm/inch)	Individual packing
Handle	Die			
Aluminum	Steel	Perfect for 10mm-13mm snap on all canvas covers, tarps, tent, static-dissipative mat and more.	180/7.1	Blister card

▶ CP-415 Cutter Stripper and Crimper



Stripper



Cutter

O.A.L. (mm/inch)	Individual packing
175/6.9	Blister card

Material	Hardness	Handle	Application		
			Strip	Cutter	Crimp
SK7	HRC: 53° ±3°	TPR	10-30 AWG (5.5-0.05mm ²)	Cutter: 12-30 AWG (2.0-0.25 mm) Cutter: 10-30 AWG (5.5-0.05 mm ²)	AWG: 12-10/16-14/22-18 JIS: 5.5-3.5/2.0/1.25mm ² DIN: 6-4/2.5/0.9 mm ²

▶ 500-037 Insulated Terminal Crimp Kit w



- Ratcheted Crimper
- Ring insulated Terminal
(22-16 AWG & Stud size: #6) X 50 pcs
(16-14 AWG & Stud size : #8) X 40 pcs
(12-10 AWG & Stud size : #10) X 20 pcs
- Butt Splice insulated
(22-16 AWG) x 30 pcs
(16-14 AWG) x 20 pcs
(12-10 AWG) x 15 pcs

▶ 902-498 Terminal Crimp Kit 100-002 Crimping Tool



- Crimper
- Butt splice connector, insulated PVC, copper tubular
30 Pcs, 22-16AWG, Red
20 Pcs, 16-14AWG, Blue
15 Pcs, 12-10AWG, Yellow
- Ring terminal, insulated PVC, brazed seam
50 Pcs, 22-16AWG, #6 Stud size, Red
40 Pcs, 16-14AWG, #8 Stud size, Blue
20 Pcs, 12-10AWG, #10 Stud size, Yellow



902-498

100-002

Material	Handle	HRC	Application			O.A.L. (mm/inch)	Individual packing
			Wire strip	Bolt cutter	Crimp		
SAE1008	PVC	HV 450-800	AWG: 10, 12, 14, 16 18, 20-22	4-40, 6-32, 10-24,10-32, 8-32	Insulation: 16-14, 12-10, 22-18 Non-insulation: 22-18, 16-14, 12-10 AWG	235/9.3	Blister card

▶ CP-151B/CP-251B/CP-351B/CP-353 Non-Insulated Terminals Ratchet Crimping Tool



- New mechanism ratcheting crimper designed for non-insulated terminals, energy saving up to 35%.
- High leverage handles, compound action mechanism provide superior mechanical advantage.
- The accurate crimping mold and self locking / releasing mechanical unit design ensure high crimping quality when crimping repeatedly.
- Made of high quality carbon steel with black oxide finish for anti-rust
- Ergonomically shaped non-slip TPR handle with eyelet design for user comfort and easy storage.
- There are 4 different sizes to meet most applications.
- Ideal for electronics and electrical installation purposes.

35%
force saving
New Mechanism

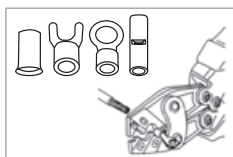

4 different sizes to meet most wire size stamped on terminals

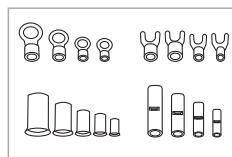

Electronics and electrical installation purposes

Model No.	Material	HRC	Handle	Crimper die profile	Application	OAL(mm)	Individual packing
CP-151B	Frame:S45C Die: AISI 4140	40° - 42°	TPR		Non-insulated spade/ring terminals,AWG 22-16/16-14/12/10, JIS 1.25/2.0/3.5/5.5 mm ² DIN 1.5/2.5/4.0/6.0 mm ²	176	Blister card
CP-251B	Frame:S45C Die: AISI 4140	40° - 42°	TPR		Non-insulated spade/ring terminals,AWG 22-16/16-14/12-10/8/6,DIN 1.5/2.5/6.0/10/16 mm ² JIS 1.25/2.0/5.5/8.0/14 mm ²	245	
CP-351B	Frame:S45C Die: AISI 4140	40° - 42°	TPR		Non-insulated spade/ring terminals, AWG 8/6/4/2, DIN 10/16/25/35 mm ² , JIS 8/14/22/38 mm ²	350	
CP-353	Frame:S45C Die: AISI 4140	40° - 42°	TPR		AWG 12-10 / 8 / 6 / 4, DIN 4-6 / 10 / 16 / 25 mm ² , JIS 5.5 / 8.0 / 14 / 22 mm ²	332	

▶ **300-055** Non-Insulated Terminal Crimper

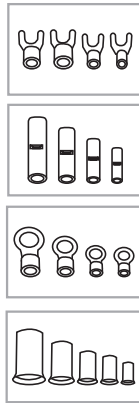

(For Non-Insulated Terminal)

- Energy saving ratcheting crimper designed for non-insulated spade/ring terminals
- High leverage handles, compound action mechanism provide superior mechanical advantage.

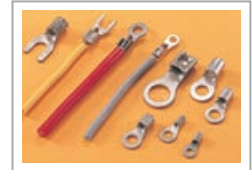

Material	HRC	Application	O.A.L (mm/inch)	Individual packing
Frame:S45C Die:SK-5	39'±2'	For Solderless, Non-Insulated terminals and AWG.22-16/16-14/12-10/8/6	185/7.3	Blister card

▶ **300-107** Heavy Duty Crimping Tool



- The best crimping solution for heavy duty tinned terminals
- Adjustable crimp nests with clearly marked gauges
- Lightweight and easy for operation
- Rugged cast steel construction for durability
- For terminating insulated and non-insulated cable lugs from AWG 8 to 250MCM copper and AWG 8 to 4/0 Aluminum



Material	HRC	Application	O.A.L (mm/inch)	Individual packing
Body: FCD45 Die: SK5	40'±2'	AWG 8, 6, 4, 2, 1/0, 2/0, 3/0, 4/0, DIN 10, 16, 25, 35, 50, 70, 95, 120mm ² , JIS 8, 14, 22, 38, 60, 70, 80, 100 mm ²	570/22.4	Inner box+ color label

Hydraulic Crimpers

▶ 902-484 QuikCrimp

- 6 Ton Capacity-not to be used with 12 ton-dies.
- Description: Battery Powered Hex Crimping Tool with die sets.
- Application: Micro computer control system-automatically detects pressure when crimping, with double safety protection. Pressure released automatic Function-tool. The tool is equipped with a double piston which is characterized by a fast approach towards the connector material, then a transfer to high pressure automatically by slower crimping. Crimping head can be smoothly turned by 350° around the longitudinal axis in order to gain better access to tight corners and other difficult working areas.
- Accepts industry standard 6 Ton dies.
- Packaging: Blow-molded case.

Comes
W/2 Batteries



QuikCrimp

REPLACEMENTS (INCLUDED IN KIT):

902-484-DIE-AWG6	Replacement Die - AWG6
902-484-DIE-AWG4	Replacement Die - AWG4
902-484-DIE-AWG2	Replacement Die - AWG2
902-484-DIE-AWG1-0	Replacement Die - AWG1/0
902-484-DIE-AWG2-0	Replacement Die - AWG2/0
902-484-DIE-AWG3-0	Replacement Die - AWG3/0
902-484-DIE-AWG4-0	Replacement Die - AWG4/0
902-484-DIE-300MCM	Replacement Die - 300MCM
902-484-DIE-350MCM	Replacement Die - 350MCM
902-484-DIE-500MCM	Replacement Die - 500MCM
902-484-DIE-600MCM	Replacement Die - 600MCM
902-484-BATTERY	Replacement Battery
902-484-CHARGER	Replacement Battery Charger

▶ 902-480 TuffCrimp 400

- Description: Hydraulic Crimping Tool - 12 Ton with interchangeable die.
- Application: Type C head with Interchangeable dies. Crimping head can rotate 360° Built-in safety valve will by-pass the oil supply when maximum pressure is reached. Automatic pressure release. Manual retract after crimping.
- Accepts industry standard 6 and 12 ton dies.

REPLACEMENTS (INCLUDED IN KIT):

902-480-DIE-AWG6	Replacement Die - AWG6
902-480-DIE-AWG4	Replacement Die - AWG4
902-480-DIE-AWG2	Replacement Die - AWG2
902-480-DIE-AWG1-0	Replacement Die - AWG1/0
902-480-DIE-AWG2-0	Replacement Die - AWG2/0
902-480-DIE-AWG3-0	Replacement Die - AWG3/0
902-480-DIE-AWG4-0	Replacement Die - AWG4/0
902-480-DIE-300MCM	Replacement Die - 300MCM
902-480-DIE-350MCM	Replacement Die - 350MCM
902-480-DIE-500MCM	Replacement Die - 500MCM
902-480-DIE-600MCM	Replacement Die - 600MCM
902-480-DIE-800MCM	Replacement Die - 800MCM



TuffCrimp 400

STRIPPERS



Pro'sKit® Strippers

All Pro'sKit precision strippers pass strict quality control using precision instruments and ensuring accurate stripping with much less effort against injury and long service life.

Pro'sKit offers a complete range of strippers, including precision wire strippers, automatic wire strippers, coaxial cable strippers, round cable slitting & ringing tools, for most applications, such as electrical wire, hook-up wire, multi-conductor cable, flat telephone cable, twisted pair round cables, coaxial cables, fiber optics cables...etc.

Gripping

Mainly used in holding, pulling and bending wires.

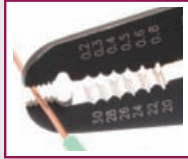

Cutting wires



With cutting edge for soft wires from Ø0.25 to Ø1.2mm (AWG 30 to 16), not for hard or thick objects.

Wire spring



The spring design is very important! It allows handles to self-open to make work faster with much less effort.



Stripping wires

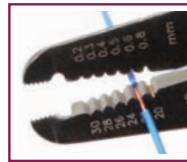

Pro'sKit precision strippers are processed by CNC machine to guarantee the accurate size of notches for accurate stripping without damage.



Pro'sKit end-action wire stripper comes with V type design and screw adjustment to preset wire size up to 3.9mm/0.15".



Pro'sKit automatic wire stripper requires much less effort to strip wires quickly. The notch size could be custom made upon special request.

2 blade stripping coaxial cables

2 blade coaxial cable stripper usually used in stripping braided shields coaxial cables

3 blade stripping coaxial cables

3 blade coaxial cable stripper usually used for stripping foil/braided shields coaxial cables

Pro'sKit coaxial cable strippers and twisted pair round cable strippers are designed with lever action that requires much less force for operating as effectively as possible. Blades made from special grade steel provide sharp and durable edges. Some of Pro'sKit strippers come with adjustable wire size function to preset wire size to meet applications requirement.

Cutting wires

Coaxial & twisted pair round cable strippers With cutting edge for cutting soft wires from Ø0.25 to Ø1.0mm (AWG 30 to 18), not for hard or thick objects.

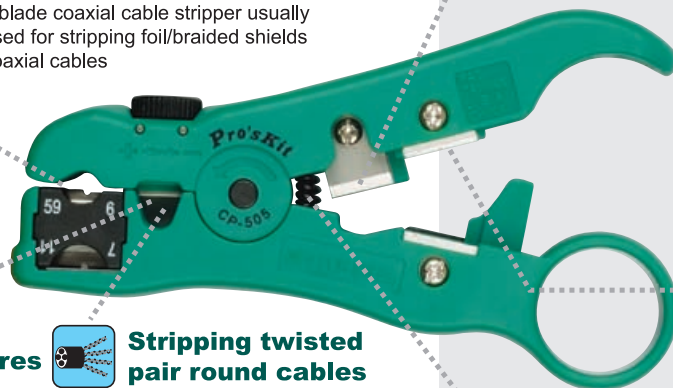

Stripping wires

For stripping electrical wires

Stripping twisted pair round cables

For stripping twisted pair round cables.

Wire spring

Stripping flat telephone cables

For stripping flat telephone cables



Safety Caution



- Blades are very sharp, please use carefully and keep them out of reach of children.
- Blades are consumables, please replace when worn or damaged.

▶ **SR-363A/SR-363B 2 in 1 Round Cable Cutter & Stripper**



SR-363A

SR-363B



• The stripper is processed by CNC machining process to ensure its accuracy.

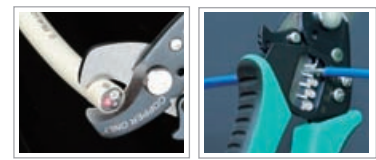

Cutting round cable Stripping

Model No.	Material		HRC	Application	O.A.L (mm/inch)	Individual packing
	Body	Handle				
SR-363A	SK5	TPR	54±3°	Stripping AWG 14/12/10/8 Cutting round cable up to 10.7mm	168/6.6	Blister card
SR-363B				Stripping AWG 20/18/16/14/12/10 Cutting round cable up to 10.7mm		

▶ **CP-301G Precision Wire Stripper**



Material: S50C

Material: PVC



Heat-treated sharp angle w/fine laser marking



Safety lock design

Material	Hardness	Handle	Application	O.A.L (mm/inch)	Individual packing
S50C	45±3°	PVC	30,28,26,24,22,20 AWG / 0.2,0.3,0.4,0.5,0.6,0.8 mm	165/6.5	Blister card

▶ **CP-302G Precision Wire Stripper**



Material: S50C

Material: PVC



Heat-treated sharp angle w/fine laser marking



Safety lock design

Material	Hardness	Handle	Application	O.A.L (mm/inch)	Individual packing
S50C	45±3°	PVC	20,18,16,14,12,10 AWG / 0.8,1.0,1.3,1.6,2.0,2.6 mm	165/6.5	Blister card

▶ **902-090 Precision Wire Stripper**



- Plier nose
- Cutter jaws
- Soft handles
- Spring return



Material	Hardness	Handle	Application	O.A.L (mm/inch)	Individual packing
SK7	50±3°	PVC	For cutting and stripping AWG 16, 14, 12, 10, 8	156/6.1	Blister card

▶ **200-047 Fiber Optic Stripper**



• Strips 125 micron glass fiber with 250 micron buffer coating without scratching or nicking glass fiber.



Material	Application	O.A.L (mm/inch)	Individual packing
Blade:S50C	Strips 125 micron glass fiber with 250 micron buffer coating without scratching or nicking glass fiber.	148/5.8	Blister card

▶ 200-072 Automatic Wire Stripper & Crimper



- The EASY STRIPPER cutters are made by precision machines for a long-life use.
- 15N 88~90 (HRC55°~60°) blade cuts wire fast and smoothly.
- Plastic insulated handles keep your work safe.

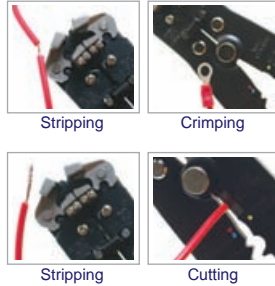

▶ 200-070 Automatic Wire Stripper & Crimper



- Micro adjusting the swivel knob to strip electrical wire gauge smaller than AWG24 (0.2mm²)
- Adjustable stopper is swiveled if user does not use this function.

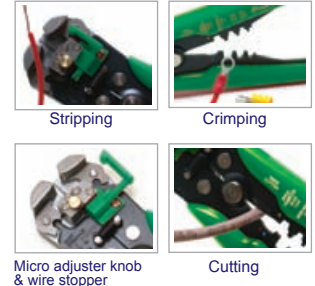

Model No.	Material			Blade HRC	Application	O.A.L. (mm/inch)	Individual packing
	Body	Blade	Handle				
200-072	SS 41	Powder metallurgy	PVC	52°~57°	Stripper range: AWG 24-10 (0.2~6.0mm ²) For insulated terminals AWG 22-10 (0.5-6.0mm ²) For non-insulated terminals AWG 22-10 (0.5-6.0mm ²) For auto ignition terminals 7-8mm	210/8.3	Blister card
200-070	SS 41	Powder metallurgy	ABS+TPR	52°~57°	Stripper range: AWG 24-10 (0.2~6.0mm ²) For insulated terminals AWG 22-10(0.5-6.0mm ²) For non-insulated terminals AWG 22-10(0.5-6.0mm ²) For auto ignition terminals 7-8mm	210/8.3	Blister card

▶ 200-085 Wire Stripper-Cutter W/Spring



▶ 200-007 Adjustable Stripper with spring 200-007W Stripper without spring



- Material: S45C
- Handness: 45°±2°



Material	Hardness	Handle	Application	O.A.L. (mm/inch)	Individual packing
S45C	45°±3°	PVC	For cutting and stripping AWG 24-10	132/5.2	Blister card

Model No.	Handle	Application	O.A.L. (mm/inch)	Individual packing
200-007	PVC	Stripping wire From10~30 AWG/4~0.5mm (with spring)	127/5.0	Blister card
200-007W	PVC	Stripping wire From10~30 AWG/4~0.5mm (without spring)	127/5.0	Blister card

▶ 200-042 Economy UTP Stripper



- A simple tool for UTP/STP cable.
- Rotate stripper just three times to extract the jacket of cable.
- Also a function for 110 punch down tool.



Material	Application	O.A.L. (mm/inch)	Individual packing
Poly-Resin	Stripping UTP/STP cable & 110 punch down	94/3.7	Blister card



▶ **200-003 Wire Stripping Tool**



Replacement blades
200-003B

Material			Blade HRC	Application	Replacement blade	O.A.L (mm/inch)	Individual packing
Body	Blade	Handle					
Zinc alloy	S45C	PVC	45°~55°	Stranded/Solid wire: AWG 22, 18-20, 14-16, 12, 10, 8	200-003B	170/6.7	Blister card

▶ **CP-246 Solar Cable Stripper**



- With adjustable length stop for accurate stripping length setting



Material			HRC	Application	OAL (mm)	Individual packing
Body	Blade	Handle				
Zinc alloy	SK5	TPR	56 ±2°	For 2.5/4/6mm ² (AWG 14/12/10) solar cable	177/7	Blister card

▶ **200-091 Wire Stripping Tool**



Cutting

Material		HRC Blade	Application	O.A.L (mm/inch)	Individual packing
Body	Blade				
ABS & low carbon steel	65Mn	45°~55°	Stripping flexible cable from 0.2~4mm ² (AWG 24-12)	172/6.8	Blister card

▶ **CP-367A Self-Adjusting Insulation Stripper**



- To adjust length stop of 8-12mm
- Fully insulated for user comfort!



Material		HRC	Application	O.A.L (mm/inch)	Individual packing
Body	Blade				
Nylon	SK5	55° ±3°	Stripping: AWG24~10/0.2~6.0mm ² Cutter: under Ø 2.0mm	115/4.5	Blister card

▶ **200-014 Self Adjusting Stripper**

- Description: Completely self-adjusting with built-in scissors action cutter and easy to change replacement blade cartridges.
- Application: AWG 28-10



Replacement blade cartridge: 900-013

Material		Application	Replacement blade	O.A.L (inch)	Individual
Body	Blade				
glass reinforced Nylon	Carbon Spring Steel	Stripping wire from AWG 28-10	900-013	8"	Blister card

▶ **200-078 Self Adjusting Stripper**

- Description: Completely self-adjusting with built-in scissors action cutter and easy to change replacement blade cartridges.
- Application: AWG 28-10



Replacement blade cartridge: 200-078B

Material		Application	Replacement blade	O.A.L (inch)	Individual
Body	Blade				
glass reinforced Nylon	Carbon Spring Steel	Stripping wire from AWG 28-10	200-78E	6"	Blister card

▶ **CP-511A Universal Stripping Tool**

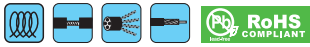

Stripping low volt cable Ø8-13mm



Stripping regular cable AWG 20-10(0.5-6mm²) and RG59, RG6 Coaxial Cable

Material		Application	O.A.L. (mm/inch)	Individual packing
Blade	Body			
SK5	ABS+TPR	Regular cable AWG 20/18/16/14/12/10(0.5/1.0/2.5/4.0/6.0 mm ²), RG59/RG6 coaxial cable, Ø8-13mm low-volt cable	125/4.9	Blister card

▶ **200-009/200-048 Rotary Cable Slitter**



Cable slitting and stripping



Replacement blade: 200-036

O.A.L. (mm/inch)	Individual packing
140/5.5	Blister card

Model No.	Material		Application	Replacement blade
	Blade	Body		
200-009	Blade: SWP spring steel Blade holder: Metal	Nylon+Fiber	Range 0.18"-1.0" diameter	200-036
200-048	Blade: SWP spring steel Blade holder: Metal	Nylon+Fiber	Range 1.0"-1.4" diameter	200-036

▶ **902-491 Longitudinal Cable Slitter**



- For slitting and stripping round cables exceeding 1" diameter.
- Removes all kinds of insulation layers
- Suitable for longitudinal and circular cutting
- Knob adjusts cutting depth up to 13/64" for different cable sheath thickness
- Blade fully retracts inside body for storage
- Replaceable blade (both sides can be used) is available.



Longitudinal cutting



Circular cutting



Adjustable cutting depth



Material		HRC	Replaceable blade	OAL (mm/inch)	Individual packing
Body	Handle	Cutting edge			
Nylon	Powder metallurgy	57°±3°	902-491-BLADE Longitudinal Cable Slitter Blade	210/8.2	Blister card

▶ CP-522 Rotary Coaxial Cable Stripper

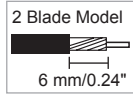

Replacement blade cassette: 902-268 (1pcs/pack)

Material		Application	O.A.L. (mm/inch)	Individual packing
Body	Blade			
ABS	SK5	coaxial cable RG59/6/7/11	128/5	Blister card

▶ 902-229 Universal Stripping Tool

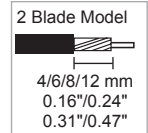
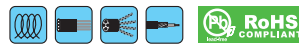

Replacement blade : 902-269 (4pcs/pack)



Replacement blade cassette: 902-268 (1pcs/pack)

Material	Application	Replacement	O.A.L. (mm/inch)	Individual packing
ABS	Stripping UTP/STP twisted pair round cable, flat telephone cable, RG-59/11/7/6 coaxial cable	Blade: 902-269 Cassette: 902-268	125/4.9	Blister card

▶ 200-016 Wire Stripper Tool



Replacement blade : 900-117(6 pcs/pack)

Material	Application	Replacement blade	O.A.L. (mm/inch)	Individual packing
ABS	Wire(UTP/STP) or wire & multiconductor cable from Ø3.2-9mm(0.13"~0.35") max.	900-117 (6 pcs/pack)	112/4.4	Blister card

▶ CP-512 Rotary Coaxial Cable Stripper



- Designed for easy single operation of one-step stripping RG-59/6/7/11 coaxial cable.
- Unique, safe design construction to avoid blade exposure and accidents.
- Finger loop promotes rotation during use, more user friendly.
- Black hook for folding back the braided shield.

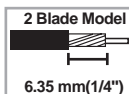

Replacement blade cassette: 5CP-505-RG(1pcs/pack)

Material		Application	OAL. (mm/inch)	Individual packing
Body	Blade			
ABS	SK5	RG-59/6/7/11	94/3.7	Blister card

▶ CP-521 Coaxial Stripping Tool



- Designed for stripping RG-58/59/6/62 coaxial cable
- Durable SK5 steel preset cutting blades provide precise, accurate cable stripping
- Special POM (Polyoxymethylene) structure, easy operation and force saving



Material		Application	OAL. (mm/inch)	Individual packing
Body	Blade			
POM	SK5	RG-58/59/6/62	115/4.5	Blister card

CP-507 Coaxial Cable Stripper & Cutter



- Designed for easy single operation of stripping and cutting RG-59, RG-6 cable.
- Unique, safe design construction to avoid blade exposure and accidents.
- Black hook and loop for folding back the braided shield.
- Finger loop promotes rotation during use.
- Pocket clip design for convenient carrying.

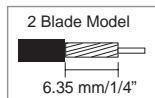

Material		Application	O.A.L. (mm/inch)	Individual packing
Body	Blade			
ABS	SK5	RG-59/6	111/4.3	Blister card

CP-509 Coaxial Stripping Tool



- With hex wrench for easy installing or removing F connector from splitter.
- Durable SK5 preset cutting blades provide precise, accurate cable stripping.

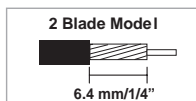

Material		Application	O.A.L. (mm)	Individual packing
Body	Blade			
ABS	SK5	RG-59/6/7/11	130/5.1	Blister card

200-064 Multi-Function Wire Stripper



Material	Application	O.A.L. (mm/inch)	Individual packing
ABS	Stripping: RG-58/59/62 coaxial cable, 26-16 AWG (0.13-1.3mm ²) precision wire, flat telephone cable, cutting: 3.5-9mm ² (12-8 AWG)	125/4.9	Blister card

200-090 Coaxial Stripper



Model No.	Material	Application	O.A.L. (mm/inch)	Individual packing
	Body			
200-090	ABS	RG-58,59,62,6	100/4	Blister card

200-081 Rotary Coaxial Cable Stripper

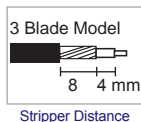

Material	Application	Replacement blade	O.A.L. (mm/inch)	Individual packing
ABS	For big cable O.D. around 10.5mm such as RG213	900-027 (6 pcs/pack)	105/4.1	Blister card

200-005 Rotary Coaxial Cable Stripper

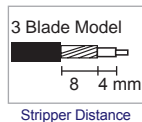

Material	Application	Replacement blade	O.A.L. (mm/inch)	Individual packing
ABS	RG-58/59/62/3C/4C	900-027(6 pcs/pack)	107/4.2	Blister card

▶ 200-051 Rotary Coaxial Stripper



Replacement blade : 900-027(6pcs/pack)

Material	Application	Replacement blade	O.A.L (mm/inch)	Individual packing
ABS	3-Blade model RG-59/62/6	900-027 (6 pcs/pack)	105/4.1	Blister card

▶ 200-050 Rotary Coaxial Stripper



Replacement blade : 900-027(6pcs/pack)

Material	Application	Replacement blade	O.A.L (mm/inch)	Individual packing
ABS	RG-59/62/6	900-027(6 pcs/pack)	105/4.1	Blister card

▶ 200-004 Rotary Coaxial Cable Stripper



2 Blade Model
4/6/8/12 mm
Stripper Distance



Replacement blade : 900-026(6pcs/pack)

Material	Application	Replacement blade	O.A.L (mm/inch)	Individual packing
ABS	RG-58/59/62/6/3C2V/4C/5C	900-026 (6 pcs/pack)	98.5/3.9	Blister card

▶ 902-334 Rotary Coaxial Stripper



- Compact and lightweight design for stripping RG-174 coaxial cable easily.
- Made of ABS handle with SK5 blade.
- Rotary stripping, one-squeeze cutting action.
- Includes a small hex wrench in handle for blade depth adjustment.



Material	Application	Replacement blade	O.A.L (mm/inch)	Individual packing
ABS	Stripping RG-174 coaxial cable	902-334-BLADES	98.5/3.9	Blister card

▶ 200-084 Coaxial Stripper



- Clothespin design
- Strip configuration for RG6, 58 and 59
- Adjustable blades



Material		O.A.L.(mm/inch)	Individual packing
Blade	Body		
SK5	ABS	120/4.7	Blister card

▶ 902-323 Coaxial Cable Stripper



- For stripping RG-58, RG-59, RG-6 coaxial cable



Optional replacement cassettes: 902-324, 902-325, 902-326



Comes with 902-324 cassette

Model No.	Material		O.A.L.(mm/inch)	Individual packing
	Blade	Body		
902-323	SK5	ABS	120/4.7	Blister card

Model No.	Cassette color	Application
902-324	Red	3 Step strips for dual crimp N series connectors Strips braid 0.236 in. (6mm) and Dielectric 0.236 in. (6 mm)
902-325	Green	2 Step strips for twinax and UHF connectors Strips braid 0.480 in. (12mm)
902-326	Blue	2 Step strips for F-type and single crimp BNC/TNC connectors Strips braid 0.250 in. (6.35mm)

▶ 200-065 Rotary Coaxial Cable Stripper



- New design for stripping ethernet, thinnet RG-62/58/59/6 coaxial cable and other cable size. Each tool does 2 or 3 step strips with out any adjustment.



3 Blade Model
8 4 mm
Stripper Distance



Material	Application	O.A.L (mm/inch)	Individual packing
ABS	Thinnet RG-62/58/59/6 coaxial cable and other cable size	108/4.3	Blister card

▶ MS-3207 Advanced 3 in 1 Connector Tool



- Comes with 3 different positions: RG-59, RG-6 and F connectors.
- Users can use one end to enlarge space between shield and insulation for RG59, another end for RG6, the other end locks F connector into tool socket and twist it onto a stripped cable end.



Material	Application	O.A.L (mm/inch)	Individual packing
PP	RG59, RG6, F connectors	100/3.9	Blister card

PUNCH DOWN TOOLS

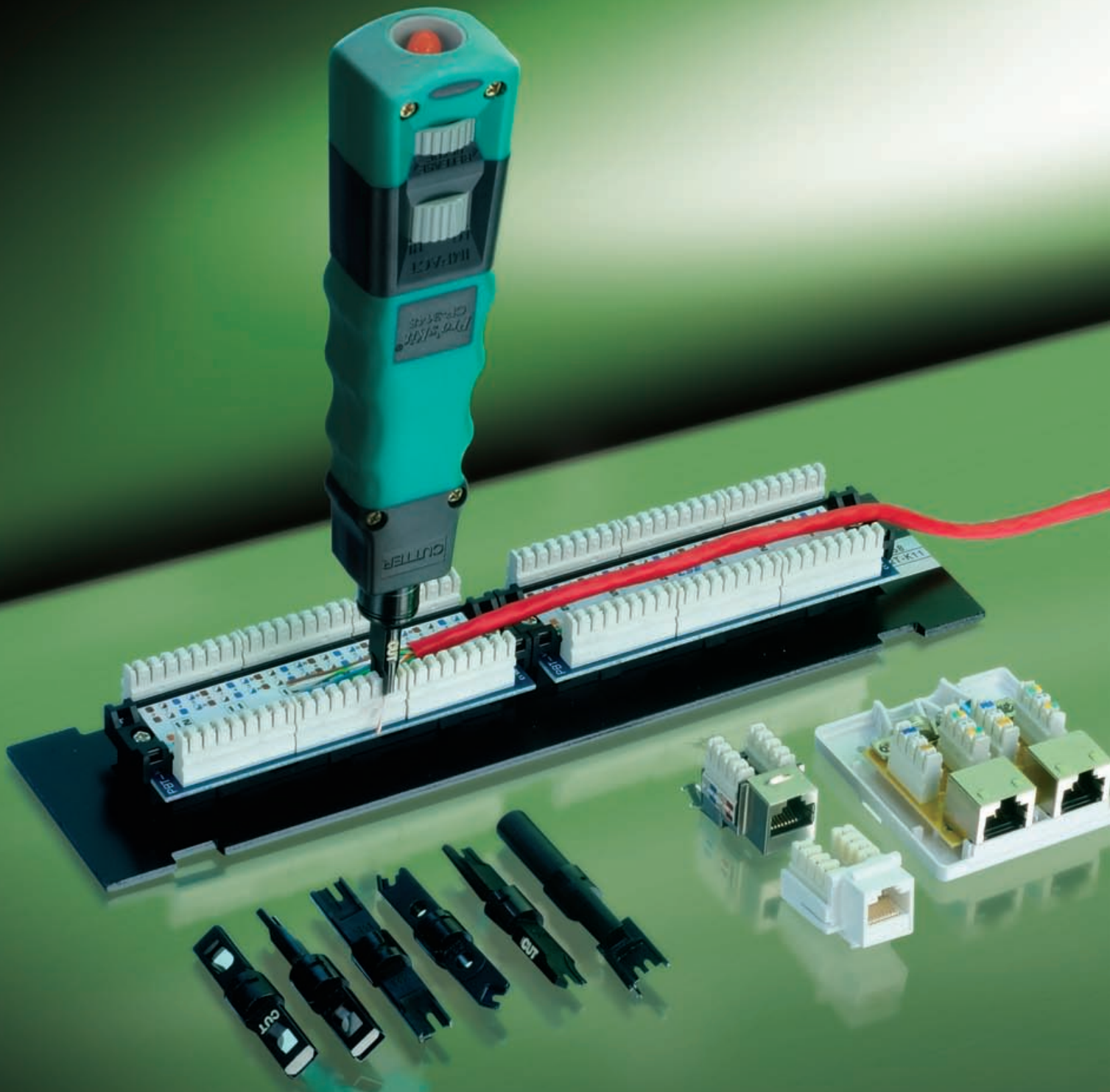

▶ 700-025 Mini Punchdown Tool



- Lid flips to allow storage of protective cap

Economy Grade



Punch and cut cable terminals



700-025-25
Holds 25pcs for retail display

Material		Application	Standard blade type	O.A.L. (mm/inch)	Individual packing
Blade	Body				
SNCM-21	Rubber (Anti-slip)	Fixed blade, not changeable	66 (with cutter)	129/5.1	Blister card

▶ 902-352 Non-Impact Punchdown Tool

- Description: Mini punch down tool (110/88 blade type) with cut function; fixed blade, not changeable non-impact tool.
- Application: Can be used with terminal blocks and keystone jacks.

Economy Grade



Material		Application	O.A.L. (mm/inch)	Individual packing
Blade	Body			
SNCM-21	Rubber (Anti-slip)	110/88 Blade Type	129/5.1	Blister card

▶ CP-3145A Punchdown Tool



Punch and cut cable terminals



- Rotatable blade holder
- Blade on both ends

Material		Standard blade type	O.A.L. (mm/inch)	Individual packing
Blade	Body			
S45C	ABS	110/88 blade, one end with, one end without cut function	128/5.1	Blister card

▶ 700-014/700-029 110 Punchdown Tool



- For use on LAN and telecom, seating 5 pairs or 4 pairs UTP (24 AWG) at a time.
- Suitable for both 110 type cable side and cross-connect side terminals blocks.
- The termination block head w/blades are changeable and reversible
- One end for seating and cutting off wires, and the other end for seating wires only.
- Patented: Taiwan.

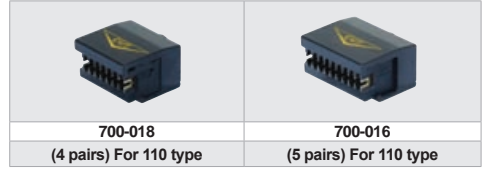

Model No.	Material		Application	Standard blade type	Optional blade	O.A.L. (mm/inch)	Individual packing
	Blade	Body					
700-014	SNCM-21	T.P.R (Anti-slip)	Hi-low adjust pressure (Hi: 15±2kg, Low: 10±2kg)	110 (5 pairs)	700-016 700-018	140/5.5(w/o blade)	Blister card
700-029	SNCM-21	T.P.R (Anti-slip)	Hi-low adjust pressure (Hi: 15±2kg, Low: 10±2kg)	110 (4 pairs)		140/5.5(w/o blade)	Blister card

▶ 900-140 Spudger

- Probe & Pick
- Tough nylon glass fiber construction
- Non-conductive - prevents shorting

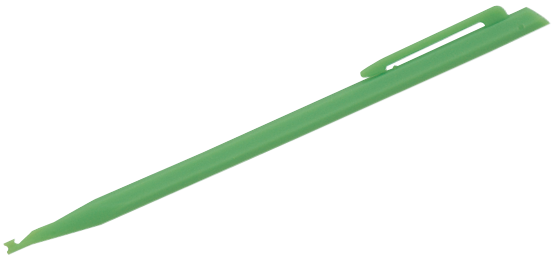

Material		O.A.L.(mm/inch)	Individual packing
Blade	Body		
Nylon	Fiber glass	142/5.6	Blister card



CP-3147/CP-3148/CP-3150
Impact Punchdown Tool



- Ergonomic cushion grip with duplex color design.
- Spare blade storage chamber in handle.
- Increased HI/LOW forces to meet demands of all Category cables through Cat6.



Model No.	Material	Application	Standard Blade type	Optional blade	O.A.L. (mm/inch)	Individual packing
CP-3147	ABS + TPR	Hi-low adjust pressure (Hi: 40lbs 178N, Low: 30lbs /133N)	Handle Only (no blades)	700-008 700-009 700-015 700-017	162/6.4 (w/o blade)	Blister card
CP-3148			110/88 & 66 both ends cut only			
CP-3150			1pcs 110/88 & 1 pcs dual 66 with cut function			

700-007/700-010/700-011/700-012
Punchdown Tool

- Spring loaded impact
- Hi-Lo settings
- Spare blade storage in handle
- Blades/Handle inter-changeable with Harris Dracon and Fluke 814 tool and other industry standard tools



Model No.	Material	Application	Standard Blade type	Optional blade	O.A.L. (mm/inch)	Individual packing
700-007	ABS	Hi-low adjust pressure (Hi:15±2kg, Low:10±2kg)	Handle Only (no blades)	700-008 700-009 700-015 700-017	146/5.7 (w/o blade)	Blister card
700-010			w/110 & 66 Blades			
700-011			w/110 Blades			
700-012			w/66 Blade			

700-020/700-021/ 700-022/700-023
Impact Punchdown Tool



- A built-in combination hook/spudger for tracing and removing wires.
- Twist-lock style holder provides quick, easy blade changes and prevents pullout.
- An additional safe storage for one more spare blade

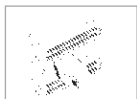

Model No.	Material	Application	Standard Blade type	Optional blade	O.A.L. (mm/inch)	Individual packing
700-020	TPR+PP (Anti-slip) (w/o Blade)	Hi-low adjust pressure (Hi:15±2kg, Low:10±2kg)	Handle Only (no blades)	700-008 700-009 700-015 700-017	168/6.6 (w/o blade)	Blister card
700-021			w/110 & 66 Blades			Blister card
700-022			w/110 Blades			Blister card
700-023			w/66 Blade			Blister card

700-027 Punchdown Tool-Locking Collar



Economy Grade



Hex type	Model No.	For terminal block
	700-026	Dual 110/88 type, one end with cut function(Hex type)

Material	Application	Standard Blade type	Replacement blade	O.A.L. (mm/inch)	Individual packing
ABS	Hi-low adjust pressure (Hi:15±2kg, Low:10±2kg)	110/88	700-026	186/7.3 (w/o blade)	Blister card

700-008/ 5CP-16A/ 700-009/ 700-015/ 700-017 Spare Blades

For CP-3147,CP-3148,CP-3150,700 series punchdown tools

Model No.	Material	For terminal block
700-008	SAE 4140	Dual 66 type, one end with cut function
5CP-16A	AISI 4140	66, 110/88 type, both ends with cut function
700-009	SAE 4140	Dual 110/88 type, one end with cut function
700-015	SAE 4140	Dual KRONE 110 type, one end with cut function
700-017	SNCM-21	BIX, with cut function



These five blades do not fit the 700-027 punchdown tool

SOLDERING / ASSEMBLY



SS-989E 2 In 1 SMD Hot Air Rework Station



- Quiet operation & ESD safe design
- Closed circuit sensor design
- Microprocessor-controlled with Calibration function features accurate temperature control and easy to repair
- Alumina Ceramic Soldering iron heating element features high power, fast warm up
- Silicone handpiece cord wire heat-resistant up to 200°C
- Comes with 18 AWG (0.823mm²) UL Certified Wires.
- Individual function start saves energy
- Auto cool-off process to prolong the life of heating element
- Interchangeable and applicable to most of branded hot air nozzles and tips

2X Lifetime
Heat Fast, 36sec 300°C
Smart Microprocessor controlled
Auto Cooling System
UL certified wires



Soldering stand



SMD rework



Soldering work



Connectorized design for quick change heater



All in one PCB design

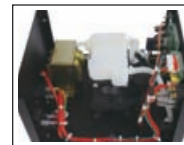

High quality assembly

Specification	
Model No.	SS-989E
Power Consumption	700W
Soldering Power	60W
Soldering Iron Temperature Range	200°C ~ 480°C (392°C ~ 896°F)
Hot Air Temperature Range	room temperature ~ 480°C (896°F)
Heating Element	Alumina ceramic heating element
Hot Air Heating Element	Metal Heating Core
Pump/Motor Type	Diaphragm Pump
Air Capacity	24L/min (max)
Equipment noise	45dB
Temperature Display	LED
Power Input	AC110-120V, 60Hz
Standard Plug	
Dimensions	255(L)x190(W)x140(H)mm
Weight	4200g
Accessories	
Soldering Iron (60W)	9SS-900N-SI(AC24V/60W) x 1pcs
Hot Air Gun	9SS-900NE-HG (AC110V~120V)
Soldering Stand	1pcs
Nozzle	9SS-900-A1 (Ø2.3mm) x 1pcs 9SS-900-A2 (Ø6.4mm) x 1pcs 9SS-900-A3 (Ø8.8mm) x 1pcs
Individual packing	Color Box

Replacement Tips:

Please refer to 5SI-216N series Soldering tip on page.87

Replacement Accessories:

Soldering Iron: 9SS-900N-SI

Hot Air Gun: 9SS-900NE-HG(AC110~120V)

Soldering Iron Heater: 9SS-900N-HT

Hot Air Gun Heater: 5SS-989NE-H(AC 110~120V)

IC Package	IC (mm)	Model No.
Single		9SS-900-A1
		9SS-900-A2
		9SS-900-A3
QFP (Quad Flat Pack)	10x10	9SS-900-B
	14x14	9SS-900-C
	17.5x17.5	9SS-900-D
	14x20	9SS-900-E
	28x28	9SS-900-F
SOP (Small Outline Package)	4.4x10	9SS-900-H
	5.6x13	9SS-900-I
	7.5x15	9SS-900-J
	7.5x18	9SS-900-K
PLCC (Plastic Leaded Chip Carrier)	17.5x17.5	9SS-900-L
	20x20	9SS-900-M
	25x25	9SS-900-N
	30x30	9SS-900-O

SS-969E SMD Rework Station

Brushless motor
 Microprocessor-controlled
 Auto-sleep and work mode
UL certified wires
 Durable metal case



Standard nozzles x 3 pcs



SMD rework



High quality assembly



Additional ground contact

- Microprocessor-controlled with closed circuit sensor design, provide high power and quick warm up times.
- Adjustable air flow, air volume and temperature to meet variety applications.
- Handle with sensor design provides real-time operating.
- Brushless motor design, quiet in operation, equipment noise less than 45dB.
- Auto cool-off process to prolong the life of heating element.
- Silicone Handpiece cord wire heat-resistant up to 200°C.
- 18 AWG (0.823mm²) UL Certified Wires.
- Metal case with painting makes more durable.

Specification	
Model No	SS-969E
Power Consumption	700W
Temperature Range	100~450°C(212~842°F)
Heating Element	Metal Heating Core
Equipment Noise	<45dB
Temperature Display	LED
Air Volume	120L / min (Max.)
Fuse type	250V / 8A
Input Voltage	AC110V~120V, 60Hz
Plug Type	E
Machine Size (mm)	170 x 170 x 140
Overall Package (mm)	280 x 185 x 170
Weight	1.43 kgs
Accessories	
Heat Air Gun	5SS-969NE-HG AC(110~120V) (225 x 60 x 40mm / wire length 140cm)
Nozzle	9SS-969-A1 x 1pcs (ID: Ø 4.3mm) 9SS-969-A2 x 1pcs (ID: Ø 7.4mm) 9SS-969-A3 x 1pcs (ID: Ø 11.2mm)
Individual packing	Color box

SS-331E LCD Desoldering Station

High Power Vacuum Pressure
 Microprocessor-controlled
 Ceramic Heater for quick heat up



140W
480°C

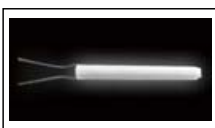

Ceramic heater features 20 times longer lifetime and better performance than transitional type heater

- Built-in high power 600mm Hg air pump, designed for lead-free desoldering of single and multi layer PCB.
- High performance provides fast heating response.
- Microprocessor controlled, provides accurate temperature control from 160 to 480°C.
- Provides fast heat up, fast recovery and high insulation resistance.
- Features 20 times longer lifetime than transitional type heater and better performance.
- Ergonomically friendly structure allows one hand operation, more efficient and comfortable.

Specification	
Voltage	100~240V AC
Power Consumption	140W
Temperature Range	160°C ~ 480°C
Control System	Microprocessor
Vacuum Pump System	Air Pump Motor
Vacuum Pressure	>600mm Hg
Heating Element	Ceramic Heater
Connecting Cord/Hose Length	105cm
Power Cord Length	1.2m
Plug Type	E
Station Size (mm)	172 x 135 x 190
Weight (kgs)	1.6
Accessories	Spare tip x 3:(ø1.2(on the gun)/ø1.0/ø1.5mm) Cleaning tool x 3 (ø0.7/ø0.9/ø1.2mm) Filter sponge x 4 (ø20.8x1+ø16.8x3)
Individual packing	Color Box

SS-257EU LCD Smart Soldering Station Stainless Steel Heating Element



- **Microprocessor controlled**
Features best performance, accurate temperature control.
- **High quality heating element, recovery fast**
Comes with high end quad-wire heating element for fast heat recovery.
- **Large LCD display with shuffle knob design**
Large screen with backlight, LCD contrast and brightness are adjustable.
Designed with manual and shuffle function for easy setting, more convenient and user friendly.
- **3data memories**
Store and recall frequently used temperature values.
- **USB port output**
Built-in DC 5V/1A USB port for power supply.
- **Smart functions**
Auto sleep and awake up function, auto power off, system lock, tip calibration and low consumption.
- **Function menu setting**
Designed with function manual and shuffle knob for easy setting, more convenient and user friendly.
- **Temperature calibration function**
- **Resettable fuse protection design**

75W
500°C

INDUSTRIAL GRADE



Large LCD w/backlight



Shuffle knob for quick setting



USB power supply

Model No.	SS-257EU
Input voltage	AC 110~120V 60Hz
Control system	Microprocessor-controlled
Power consumption	75W
Display	LCD 74x40mm, 240 x120 dot. backlight
Temperature range	30~500°C±10°C(86~932°F±50°F)
Temperature calibration	±0~699°C(32~1290°F)
Temperature stability	±2°C/±36°F (no load)
Heating element	High end quad-wire Heater
Plug	E
Sleep mode	OFF, 1~360min. adjustment
Temperature of sleep mode	30~400°C/86~752°F
USB port output	DC 5V/1A
Memory	3 sets
Tip-to-Ground resistance / potential	≤ 2 Ω / ≤ 2 mV
Size	180 × 150 × 106 mm
Weight	2.36 Kg

Replacement Accessories:

Soldering Iron: 9SS-257-SI

Soldering Iron Heater: 9SS-257-HT

Replacement Tips:

Please refer to 5SI-216N series Soldering tip on page 87

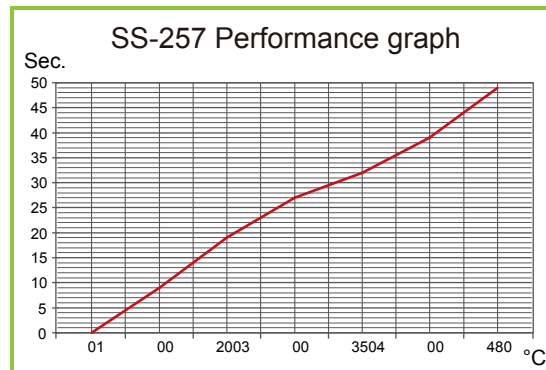

▶ SS-206EU / SS-207EU Temperature-Controlled Soldering Station



TÜV

UL certified wires and components
Modular design for quick repair
Alumina ceramic heater
Compact size design
Lead free process



SS-206EU



SS-207EU

Features

- Comply with cTUVus safe certification.
- Temperature range 200- 480°C (392-896°F).
- Soldering iron handles are insulated and ergonomically designed for ease and comfort.
- Celsius or fahrenheit temperature setting.
- Control IC modular design for easy and quick repair.
- Resettable fuse protection design.



Modular design for easy repair



High quality assembly

Model No.	SS-206EU	SS-207EU
Power consumption	60W	
Input Voltage	110~120V 60Hz	
Output voltage	24VAC	
Display	Analog	Digital
Heater	Alumina ceramic heating element	
Temperature range	200°C- 480°C (392°F-896°F)	
Station Size(mm)	145x90x120	
Standard Plug	E _i type	
Replacement heater	9SS-900N-HT	
Soldering Iron	9SS-900N-SI	
Individual packing	Color Box	

Replacement tips:



OAL:43mm I.D.: 4.0mm O.D: 6.3mm

	5SI-216-B (Included)		5SI-216N-3.2D
	5SI-216N-B1.0		5SI-216N-1C
	5SI-216N-BC		5SI-216N-2C
	5SI-216N-0.8D		5SI-216N-3C
	5SI-216N-1.2D		5SI-216N-4C
	5SI-216N-1.6D		5SI-216N-I
	5SI-216N-2.4D		5SI-216N-K

▶ SS-611A Heat Gun Set



- Smart overheat protection design
- Automatic cool air flow to reduce waiting time from overheating shut down while working
- 2 temperature settings from 300°C~500°C for a variety of applications
- Dual color ergonomic grip and lightweight design provides greater comfort
- Includes 4 nozzles and 1 scraping tool with carrying case, easy to carry and store



Included 4 Nozzles + 1 Scraper



Paint and varnish removal

Voltage	Power	Dual temperature range	Case size (mm/inch)	Standard plug
120V 60Hz	I-750W II-1500W	I-300°C II-500°C	300x280x90mm 11.8" x 11" x 3.5"	A

Individual packing: Color sleeve + shrink pack

⚠ Caution:

- For safety, after using this product for one hour, please shut-off for 10 minutes to cool down temperature
- If this product is overheating after shut-off, the protection function will be coercively booted and shut this appliance off for 10 minutes. To prevent any overheating problem, never put the appliance down on its air outlet nozzle. Always keep its outlet nozzle upward or put it on one of its sides.

▶ 902-458 Heat Gun with LCD Display



- Mabuchi motor provides high performance and long life.
- Large LCD display for easy monitoring.
- Air flow and temperature control system maintains constant temperature.
- Perfect for applications requiring consistent application of heating.
- Adjustable, stepless temperature range from 212°F~1202°F(100°C~650°C).
- Smart protection design switches off automatically to prevent overheating.
- 20 second automatic cool air flow prevents accidental burns and extends the life of the heating element.
- Includes 2 extra nozzles for a wide variety of applications.



Removal of window glazing



Paint removal



Voltage	Power consumption max.	Switch-I	Switch-II	Switch-III	Cable length	Certificate	Standard plug	Accessories
120V 60Hz	1500W	11 CFM 122°F (50°C)	11 CFM 158~1022°F (70~550°C)	18 CFM 158~1022°F (70~550°C)	6 Ft.	c-UL	A	4 nozzles and 1 scraping tool

Individual packing: Color sleeve + shrink pack

▶ 900-259 Mini Soldering Station

- Precision temperature control: ~330°C (~626°F)
- Super slim, pen-like style for greater control and visibility
- Specially designed for repairs to cell phones and PC boards
- Conductive soldering stand
- Dual voltage AC 110/220V



Mini Ceramic Heater & Tip

Replacement tip:



Voltage	Consumption	Temperature	Standard plug	Individual packing
110V	4~14W	~330°C (~626°F)	E (I)	Color box

▶ 902-512 / 902-513 Dual Wattage Soldering Iron



DUAL WATTAGE professional soldering iron, excellent for all electronics hobbyists as well as industrial users.

- Selectable switch lets you easily swap the power setting.
- Tailor your temperature depending on your project.
- Ergonomic handle with comfortable grip for max. user comfort.
- Comes with long life tip and safety stand.
- Includes sheet metal stand.

902-512 15/30W Dual Wattage Soldering Iron

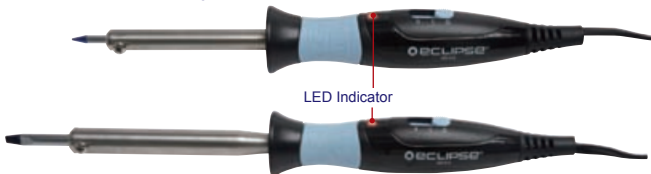

902-513 30/60W Dual Wattage Soldering Iron

Model No	Voltage	Consumption	Individual packing
902-512	120V	15/30W	Blister card
902-513	120V	30/60W	Blister card

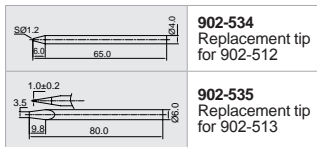

▶ 902-329 25W Soldering Iron



Replacement tip:

902-333 (Pencil type)

Voltage	Consumption	Temperature	Handle color	Standard plug	Individual packing
120V	25W	340°C	Black	A (I)	Blister card

▶ 900-035 20W~40W Soldering Station

- 20W-40W switchable solder station
- UL approved
- Comes with pencil tip



Replacement tip:

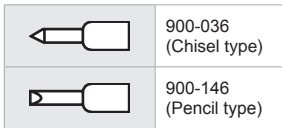

Voltage	Consumption	Temperature	Standard plug	Individual packing
110V	20~40W	400°C±30%	A (I)	Color box

▶ SI-125A-15/SI-125A-20 Mini Soldering Iron



- Specifically for areas that require small size and fine application.
- Lightweight and triangle shape plastic handle for user comfort.
- Heats up fast but less wattage required.
- Tips screw on and off for easy changing.



Standard plug	OAL (mm/inch)	Individual packing
A (I)	168/6.6	Blister card

Model No.	Voltage	Consumption	Temperature	Heater	Handle color
SI-125A-15	110-120V	15W	360°C±10%	Ceramic heater	Orange
SI-125A-20	110-120V	20W	410°C±10%	Ceramic heater	Orange

▶ 900-018N 30W Soldering Iron

- Converts easily from pen to gun configuration.
- When not in use handle covers tip for storage protection.

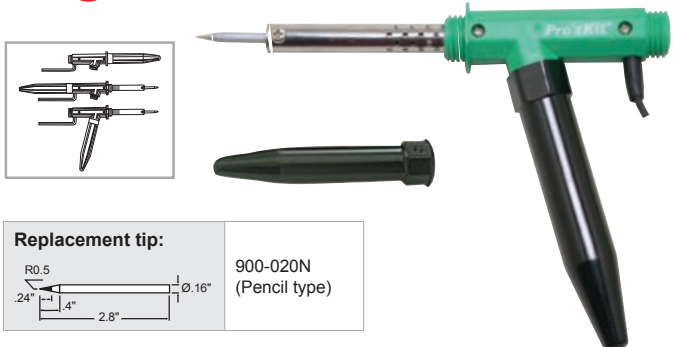

Replacement tip:

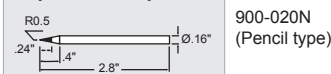

Voltage	Consumption	Temperature	Handle color	Standard plug	Individual packing
110~120V	30W	400°C±10%	Green / Black	E (I)	Blister card

GS-23K Gas Soldering Iron Kit-Auto Ignition



- Auto ignition for starting and operating easily and safely under any condition.
- Safety ignition switch complies with CPSC standard to prevent children misuse.
- Comes with TR90 high transparent nylon gas tank features long service life and more safety.
- With Ceramic heater for long service life.
- Adjustable flame control for precision use.
- Butane is easy to refill and check with see-through fuel window.
- Complete kit comes in a plastic case and meets a variety of operating applications.

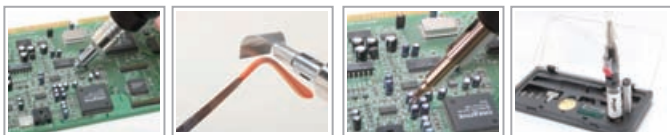

Hot blow up to 600°C Torch up to 1300°C Soldering up to 500°C Stand support for convenient work



Soldering Temperature	Hot Blow Temperature	Torch Temperature	Fuel Capacity	Time	Size (mm/inch)	Individual packing
500°C	600°C	1300°C	15ml	90min	245 x Ø 29mm/ 9.6xØ1.1"	Color Box

GS-210 Professional Soldering Iron & Gas Torch

- Auto ignition is easy to start and operate under any condition
- Adjustable flame control for precision use
- Built-in stand for safety and easy placement during work
- Needle soldering tip and soldering head included
- Optional tips available for different applications



Soldering temperature	Hot blow temperature	Torch temperature	Fuel cap.	Time	Size (mm/inch)	Individual packing
370 °C	500 °C	1300°C	7 ml	30~40 min	170xØ 24 6.7xØ0.94	Blister card



900-004 ESD Mini-Desolder Pump



DP-366D Desoldering Pump



DP-366J Desoldering Pump



DP-366P Desoldering Pump



Model No.	Material	Suction Capability	OAL(mm/inch)	Individual packing
900-004	Aluminum	30cm-Hg	163/6.4	Blister card
DP-366D	ABS	32cm-Hg	210/8.3	Blister card
DP-366P	ABS	40cm-Hg	330/13.0	Blister card
DP-366J	PC	32cm-Hg	210/8.3	Blister card

▶ GK-368 Battery Operated Glue Gun



- Cordless design, free from A/C power cords and dangerous dangling cords.
- Convenience LED light allows for work in dark areas.
- Closed viewing window for easy glue stick checking, more constant temperature and dust free operation.
- For Ø7.5mm glue sticks
- Perfect for toys and models, corkboards, DIY projects, school projects, quick repairs around the house, decorations, wood crafts and more.



Power	Preheat time	Power source	Optional glue sticks	Running time
7W/6V	3-4 minutes	1.5V AA battery x 4 (not included)	Model No.: GK-67330-8, Ø7.5mm Glue Sticks, 8 pcs /pack	45 minutes (Alkaline type)

▶ 902-227 Helping Hands Octopus Clamp Kit



- Maximum thickness of table or bench edge: 1.5"(40mm)
- Including magnifier arm x1, magnet arm x1, stayput arms x4
- Magnification: 2.5X

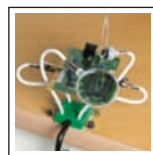

Multi function

Individual packing: Blister card

▶ 900-115 Glue Gun



- Solid state electric glue provides a fast, easy way to dispense hot melt adhesive for hundreds of fastening and repair jobs.
- Specially designed feed mechanism, spring-tensioned nozzle and silicone sleeve assure precise control of adhesive flow for neater work.



Decoration model and more...



Models

Voltage	Power	Preheat time	Flow of glue	Standard plug	Individual packing
120V	30-80W	10 min	14-16g per min	A (I)	Double blister

▶ 900-118A Glue Stick

- 6pcs per pack

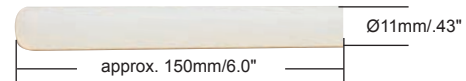

▶ 902-094 Helping Hands



- The practical helper for soldering work for electronics and model-making.
- Holding clamps adjustable in many ways, complete with magnifying acrylic 3.5"(90mm) dia: 2.5X.
- Sturdy stand.



Individual packing: Color box

▶ SN-390 Adjustable Soldering Clamp Holder

Particularly designed to clamp a circuit board, ideal for PCB soldering and desoldering rework.

- Rigid metal structure with stabilizing rubber pad, perfect for your project.
- The 2 adjustable grip retractable stand accommodates various board sizes up to 200mm width and 4 different thicknesses.
- The clamps allow 360 degrees rotation and can be secured in any position, make your soldering projects more easy and efficient.
- Lightweight design, easy to carry.



4 different thickness holders

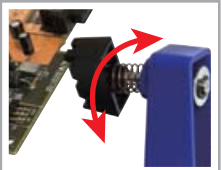

Allows 360 degrees rotation and can be secured in any position



Demo only, PC board not included.

Material	Max. circuit board size	Circuit board thick	Dimensions	Weight	Individual packing
ABS arm + metal base	20 x 14 cm / 7.9x5.5"	1.2 / 1.8 / 2.0 / 3.0mm	30 x 16.5 x 12.5 cm 1.2 x 0.6 x 0.5"	450g	Color Box

▶ SN-396 Soldering Helping Hand with LED Magnifier

- **3 helping hand clips**
- **Powered by batteries or adaptor**
- **Excellent solution for soldering work**



- Comes with 16 SMD LEDs illuminating, energy saving and super bright.
- The magnifier is on a flexible neck gives you 2.5X(6D) and 6.25X(21D) magnification for finishing those fine solder joints.
- The adjustable 3 helping hands clips feature precise positioning and secure gripping of your work.
- The magnifier is powered by either 4 AA batteries or external power adaptor.
- The set includes solder spool brackets, soldering iron holder, cleaning sponge & brass tip cleaner and solder flux.



Magnifying Lens size	Magnification	Magnification Material	Light source	Neck length (for magnifier)	Neck length (for alligator clips)
Ø90mm & Ø20mm	2.5X(6D) + 6.25X(21D)	Acrylic	16 pcs SMD LEDs	265mm 10.4"	250mm 9.8"

Base size	Power Battery	Power Adaptor	Accessories	Weight	Individual packing
190x170mm	1.5V AA x 4pcs batteries (not included)	DC 6V adaptor input (not included)	Sponge size(30 x 50mm), Solder flux x 10g, Brass Tip Cleaner x 17g	1,150 g	Color Box

▶ Helping Hands

900-037
RoHS COMPLIANT



900-206
RoHS COMPLIANT



900-015
RoHS COMPLIANT

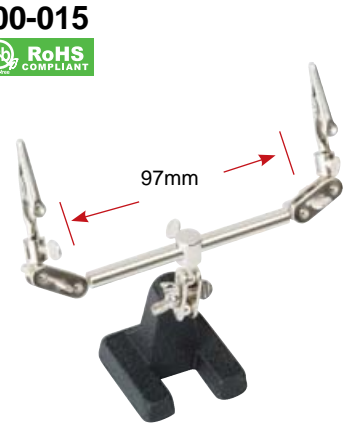

Model No.	Material			Magnification	Base OAL.	Individual packing
	Magnifer	Arm	Base			
900-037	Acrylic	Low carbon steel	Cast-iron	Ø 50mm 6D(2.5X)	54x54x57mm / 2.1x2.1x2.2"	Color box
900-206	Glass			Ø 60mm 7.5D(3X)	55x55x35 / 2.17x2.17x1.38"	
900-015	N/A			N/A	54x54x57 / 2.1x2.1x2.2"	

▶ **900-016** Soldering Stand



Individual packing: Color box

▶ **6S-2** Soldering Stand



Individual packing: Color box

▶ **900-099** Soldering Stand



Individual packing: Color box

▶ **902-095** Mini Soldering Stand



- 2 position iron holder stand
- Built-in sponge tray



Individual packing: Color box(2pcs / pack)

▶ **900-242/ 900-243** Soldering Tip Cleaner Replacement Tip Cleaner



- No water necessary.
- Anti-slip pad.
- Made of low abrasive brass shavings.
- Cleans better than conventional sponges.
- No temperature drop as in conventional sponges.

Model No.	Description	Spec	Individual packing
900-242	Soldering tip cleaner	ø83 x 27mm/ 3.3" x 1.1	Blister card
900-243	Replacement tip cleaner	25g	Hanger (5 pcs/pack)

▶ **902-335** Cut To Size Soldering Sponge



Material	Size(mm/inch)	Individual packing
Cellulose	100x110/3.9x7.8	Hanger (3 pcs/pack)

▶ **900-100** Solder Aid Tools



- This kit contains specialized tools you need for soldering: Assisting rods for P.C.board soldering work.

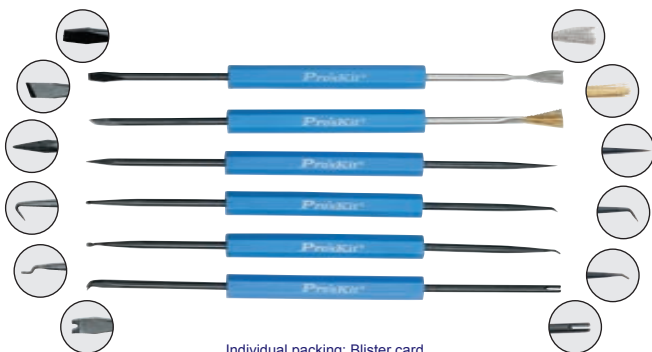

Individual packing: Blister card

▶ **900-250** Solder Aid Tools



- This kit contains specialized tools you need for soldering: a heat sink to protect your heat-sensitive devices, knife and brush, scraper and hook, fork and spike.



Individual packing: Blister card

▶ 900-247 Round Hole Bread Board



- 840 tie points
- Round hole designed for easy plug and pull
- Expandable by combining several boards together to meet your different requirement
- Wearproof material made of ABS & phosphor bronze with good flexibility and electric conductivity



Excellent expandability

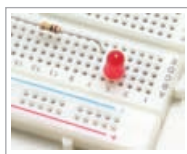

Friendly graduations

Individual packing
Blister card

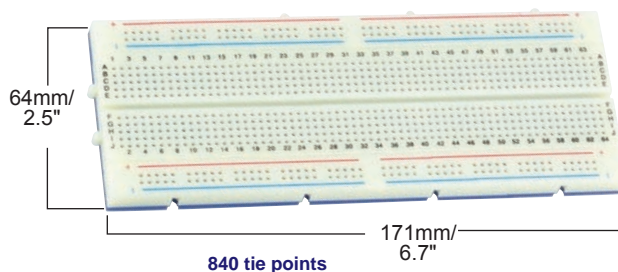

▶ 900-248/900-249 Round Hole Bread Board



Application:

Used as a simulated layout for R&D and students.

Features:

- Round hole designed for easy plug and pull
- Expandable by combining several boards together to meet your different requirement
- Wearproof material made of ABS & phosphor bronze with good flexibility and electric conductivity



Edge plate can easily fold up

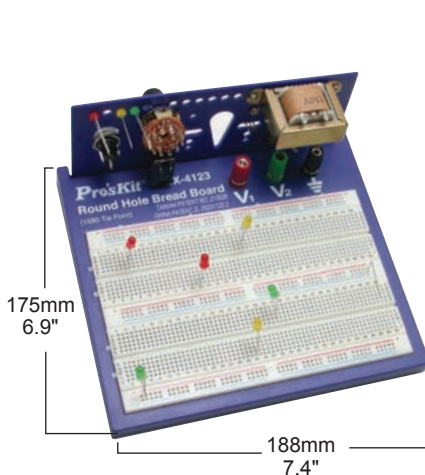

900-248 1580 tie points (Demo only)

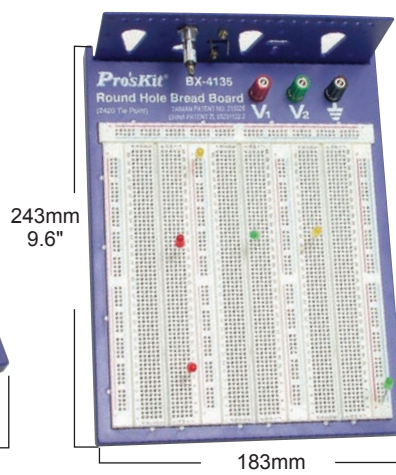

900-249 2420 tie points (Demo only)

Model No.	Tie points	Individual packing
900-248	1580	Blister card
900-249	2420	

TAIWAN PATENT NO. 215526
CHINA PATENT ZL 03231122.2

▶ 900-271/900-272 Bread Board Accessory



- 70 pcs of 22 AWG solid wires
- Pre-cut, pre stripped and pre-formed on each end
- Variety of colors
- Completely reusable
- 14 lengths x 5 pcs each
- (2, 5, 7, 10, 12, 15, 17, 20, 22, 25, 50, 75, 100 and 125mm)

- 350pcs of 22 AWG solid wires
- Pre-cut, pre stripped and pre-formed on each end
- Variety of colors
- Completely reusable
- 14 lengths x 25 pcs each
- (2, 5, 7, 10, 12, 15, 17, 20, 22, 25, 50, 75, 100 and 125mm)



900-271

Case Size (mm/inch)	Individual packing
165x55x15/ 6.5x2.2x0.6	Poly bag + Hanger



900-272

Case Size (mm/inch)	Individual packing
178x90x28/ 7x3.5x1.1	Poly bag + Hanger

▶ 900-238 Vacuum Pick-Up Tool

- The hand-held SMD vacuum pick-up tool is ideal for picking up and moving electronic components, large or small. With fountain pen dimensions, it fits easily into your hand or pocket.
- The new high-power probes have longer holding action.

Function:
 • Lightweight, portable and suitable for picking and placing small components weighing up to 50 grams and having a flat surface, dilly packages and surface mount components, etc.

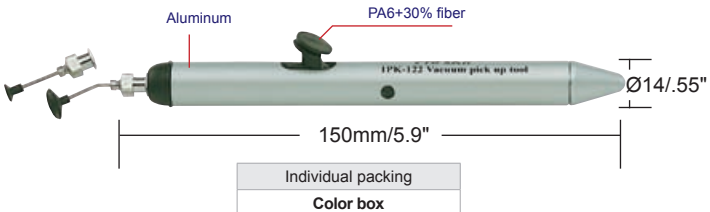

Individual packing
Color box

▶ 900-251/900-252/900-253 Liquid Dispenser Bottles

- Ⓟ Polyethylene bottles are not chemically reactive.
- Ⓟ Purity pump to prevent backwash of contaminants into container.



Model No.	Description	Individual packing
900-251	4 oz/114 ml	Poly bag + Hanger
900-252	6 oz/170 ml	Poly bag + Hanger
900-253	8 oz/227 ml	Poly bag + Hanger

▶ MS-018 Leak Proof Dispenser Pump Bottle



- Portable leak proof construction.
- Bottle scale indication.
- Anti dumping of cone design.
- No chemical reaction Polypropylene material.
- Perfect for fiber cleaning, nail treatment and more.

Material	Capacity	Individual packing
Polypropylene	180ml	Poly bag

▶ 900-270 Mini Vacuum Cleaner



Material	OAL (mm/inch)	Individual packing
polypropylene	128/5"	Blister card

▶ 900-058/900-181/900-222 Stainless Steel Forceps



Model No.	Material	Type	OAL (mm/inch)	Individual packing
900-058	AISI 410	Straight	130/5"	Blister card
900-181			160/6"	
900-222			Curved	

▶ 900-230 Flux Bottle



• Dispenses flux evenly with a fine tipped needle.

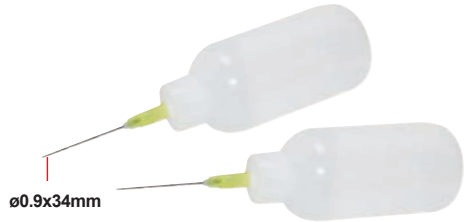

Material	OAL. (mm/inch)	Individual packing
PE	ø37x122/ø1.5x4.8	Poly bag + Hanger (2 pcs/pack)

▶ 902-529 Anti-Static Liquid Dispenser Bottle



- High Density Polyethylene (HDPE) durAstatic bottles are ESD Safe
- Long lasting dissipative properties - Rtt: 10⁹ to < 1 x 10¹⁰ ohms tested
- Stainless steel bottle cap with a transparent pad

Description	Capacity	Individual packing
High Density Polyethylene (HDPE)	180ml (6oz)	Poly bag

▶ MS-153C Bulb Blower



Material	Pump capacity	OAL. (mm/inch)	Individual packing
PVC	110 ml	ø 56x110mm / ø2.2"x5.5"	Blister card

SCREWDRIVERS & BITS



Screwdrivers/Bits

Pro'sKit® screwdrivers with ergonomic handles, high quality blades and super hardened finished tips feature the maximum torque and user comfort.

Handle styles:

Pro'sKit® screwdrivers come in various handle styles to meet requirements of most applications, including PVC, ABS, dual color non-slip ABS&TPR, ESD safe, handles.



PVC / ABS handles



Dual color ABS&TPR handles, non-slip



ESD safe handle



VDE 1000V Insulated handles



Ratchet types:

Pro'sKit® screwdrivers have a variety of styles. Some come with ratchet mechanism design, and some are articulated handles. Ratchet screwdriver requires less force but more torque than conventional handles. It comes with 3 positions adjustment: forward, reverse rotation and fixed. The articulated handles allow to adjust the angle up to 180° for quick screwing, especially in the narrow working space.

Material of bits and blades:

Pro'sKit® screwdriver blades and bits are made from high grade steel to meet the most of applications, including Chrome-Vanadium steel(Cr-V), Chrome-Molybdenum Vanadium steel(Cr-Mo-V), S2 alloy steel(S2). Tip with special hardened finished for perfect fit in screw slots and lasting durability.

Black tip

Black tip with hardened finished guarantees a long service life and increased corrosion protection.

Magnetic

Magnetic tip for greater fastener control and guarantees a perfect fit every time.

Symbols for blade and bit shapes

Pro'sKit® screwdrivers combination with many bit specifications for applying most screws.

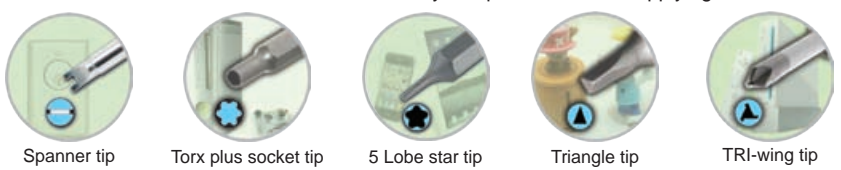

Spanner tip

Torx plus socket tip

5 Lobe star tip

Triangle tip

TRI-wing tip

Safety Caution
• Don't use tools on live or energized circuits or equipment.

		Slotted			Spanner			Clutch			Wing nut driver
		Phillips			Phillips tamper proof			Pozidriv			Torq
		Torx®			Torx® tamper proof			Star			Spline
		Hex			Hex tamper proof			Ball hex			Nut
		Square			Square tamper proof			Triangle			TRI-wing
		Bihexagon socket			Square drive socket (for adapter)			Needle type bits			5-Lobe star tip

180°

SD-083 ESD Precision Screwdriver



Pro'sKit Precision ESD Safe Screwdrivers are tested in accordance with ESD Association standard; meet the requirements for tools used in static sensitive areas. Surface resistance of handles is $10^7 \sim 10^9 \Omega$



SD-0839 ESD Precision Screwdriver Set



Model No.	Spec	Blade length (inch)
SD-083-S3	⊖	2.0
SD-083-S4	⊖	2.4
SD-083-S5	⊖	3.0
SD-083-P2	⊕	#00
SD-083-P3	⊕	#0
SD-083-P4	⊕	#1
SD-083-T4	⊗	T4
SD-083-T5H	⊗	T5H
SD-083-T6H	⊗	T6H

Individual packing: Blister card

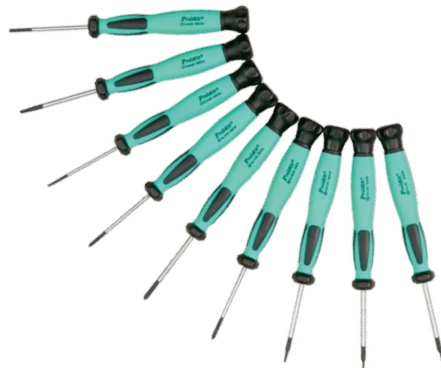

Contents	
⊕	SD-083-P2 SD-083-P3 SD-083-P4
⊖	SD-083-S3 SD-083-S4 SD-083-S5
⊗	SD-083-T4
⊗	SD-083-T5H SD-083-T6H

Individual packing: Pouch

Ceramic Driver

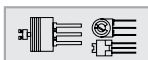

RF coils & trimmers

Handle: ABS

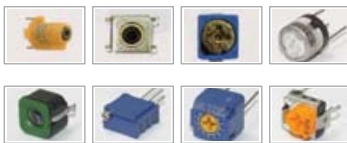

Model No.	Spec.
800-114	⊖ 0.4x0.9mm (0.015"x0.035")
800-115	⊖ 0.4x1.2mm (0.015"x0.047")
800-116	⊖ 0.4x1.4mm (0.015"x0.055")
800-117	⊖ 0.4x1.8mm (0.015"x0.070")
800-118	⊖ 0.4x2.0mm (0.015"x0.078")
800-119	⊖ 0.4x2.4mm (0.015"x0.094")
800-120	⊖ 0.7x2.4mm (0.027"x0.094")
800-121	⊕ PH0
800-122	⊕ PH1.7

Individual packing: Double blister



800-130 3 PC Anti-Static Alignment Tool Kit



- For protection of sensitive components
- Duplex, trimmer and square/hex tool
- Conductive nylon-avoid high voltage

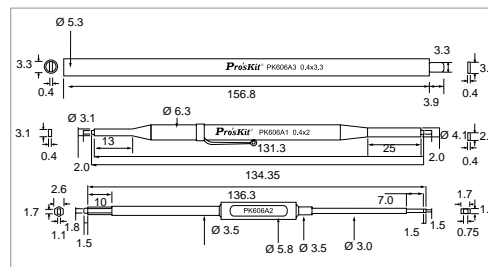

Material	Spec.
Conductive nylon	As sketch

Individual packing: Blister card



SD-081 Series Precision Screwdriver/Nut Driver



Model No.	Spec.	Blade length	Model No.	Spec.	Blade length	Model No.	Spec.	Blade length
SD-081-S1	⊖ 1.0	2"	SD-081-TRI1	⊕ #1	2"	SD-081-M3	⊕ M3.0	2.8"
SD-081-S2	⊖ 1.6	2"	SD-081-T1	⊕ T1	2"	SD-081-M3.5	⊕ M3.5	2.8"
SD-081-S3	⊖ 2.0	2"	SD-081-T2	⊕ T2	2"	SD-081-M4	⊕ M4.0	2.8"
SD-081-S4	⊖ 2.4	2"	SD-081-T3	⊕ T3	2"	SD-081-M4.5	⊕ M4.5	2.8"
SD-081-S5	⊖ 3.0	2"	SD-081-T4	⊕ T4	2"	SD-081-M5	⊕ M5	2.8"
SD-081-S6	⊖ 2.4	3"	SD-081-T5	⊕ T5	2"	SD-081-M5.5	⊕ M5.5	2.8"
SD-081-S7	⊖ 3.0	3.9"	SD-081-T6	⊕ T6	2"	SD-081-M6	⊕ M6	2.8"
SD-081-S8	⊖ 4.0	5.9"	SD-081-T7	⊕ T7	2"	SD-081-H1	⊕ 0.7	2"
SD-081-P1	⊕ #000	2"	SD-081-T8	⊕ T8	2"	SD-081-H2	⊕ 0.9	2"
SD-081-P2	⊕ #00	2"	SD-081-T9	⊕ T9	2"	SD-081-H3	⊕ 1.3	2"
SD-081-P3	⊕ #0	2"	SD-081-T10	⊕ T10	2"	SD-081-H4	⊕ 1.5	2"
SD-081-P4	⊕ #1	2"	SD-081-T15	⊕ T15	2"	SD-081-H5	⊕ 2.0	2"
SD-081-P5	⊕ #0	3"	SD-081-T20	⊕ T20	2"	SD-081-H6	⊕ 2.5	2"
SD-081-P6	⊕ #1	3.9"	SD-081-T5H	⊕ T5H	2"	SD-081-H7	⊕ 3.0	2"
SD-081-P7	⊕ #1	5.9"	SD-081-T6H	⊕ T6H	2"	SD-081-Z1	⊕ #000	2"
SD-081-TA20	⊕ 2.0	2"	SD-081-T7H	⊕ T7H	2"	SD-081-Z2	⊕ #00	2"
SD-081-TA23	⊕ 2.3	2"	SD-081-T8H	⊕ T8H	2"	SD-081-Z3	⊕ #0	2"
SD-081-TA27	⊕ 2.7	2"	SD-081-T9H	⊕ T9H	2"	SD-081-Z4	⊕ #1	2"
SD-081-TRI000	⊕ #000	2"	SD-081-T10H	⊕ T10H	2"	SD-081-TS1	⊕ TS1	2"
SD-081-TRI00	⊕ #00	2"	SD-081-T15H	⊕ T15H	2"	SD-081-A1	⊕ A1	2"
SD-081-TRI0	⊕ #0	2"	SD-081-T20H	⊕ T20H	2"	SD-081-A2	⊕ A2	2"

Individual packing: Blister card

SD-081A 7 PC Electronic Set



Contents	
AISI 8660 Cr-Mo-V alloy steel with TPR Handle screwdriver X 7Pcs (OAL:147mm/5.8")	
⊖ 1.6x2", 2.0x2", 2.4x2", 3.0x2"	⊕ #00x2", #0x2", #1x2"
Carrying case: 170x139x23mm/ 6.7"x5.5"x0.91"	

Individual packing: Plastic box + Color box

SD-081G 4 PC TRI-wing Precision Screwdriver Set



Contents
⊕ SD-081-TRI000, SD-081-TRI00, SD-081-TRI0, SD-081-TRI

Individual packing: Blister card



▶ 800-129 33 PC Screwdriver Set W/Bits



Contents	
TPR non-slip handle with bits holder	
30pcs 4mm hex x 28mm (1.12"), Material: AISI 8660 Cr-Mo-V steel	
+	PH000, PH00, PH0, PH1
-	SL1.0, SL1.5, SL2.0, SL2.5, SL3.0, SL3.5, SL4.0
⊕	T4, T5, T6, T7, T8, T9, T10, T15, T20
⊙	H0.7, H0.9, H1.3, H1.5, H2.0, H2.5, H3.0, H4.0
+	PZ1, PZ0
2 pcs ø4mm/ ø0.16" socket, material: AISI 6150 Cr-V steel	
⊙	Socket: M5, M6
Carrying Case: 170x139x23mm/ 6.7"x5.5"x0.9"	

Individual packing: Plastic box + Color Label



▶ SD-081E 12 IN 1 Precision Screwdriver Set w/Bit



Contents	
TPR non-slip handle with bits holder	
12pcs 4mm hex x 28mm (1.12"), Material: AISI 8660 Cr-Mo-V steel	
-	SL2.0, 2.5, 3.0, 4.0
+	#000, #00, #0, #1
⊙	T6, T7, T8, T9
Carrying case: 134x65x25mm/ 5.3"x2.6"x1"	

Individual packing: Plastic box + Color box



▶ SD-9828 58 PC Driver Kit



Ideal for smartphone opening of tablets, notebooks, electronic device cases and most branded video games such as Apple, HTC, Samsung, LG, Nokia, Sony, Sega, Microsoft, Nintendo and more.

Contents	
42 pcs Φ4.0x28 mm, material : AISI 8660 Cr-Mo-V steel	
+	#000, #00, #0, #1, #2
-	1.0, 1.3, 1.5, 2.0, 2.5, 3.0, 3.5, 4.0 mm
⊕	T5H, T6H, T7H, T8H, T9H, T10H, T15H, T20H
⊕	T3, T4
⊙	0.7, 0.9, 1.3, 1.5, 2.0, 2.5, 3.0, 3.5, 4.0 mm
⊕	#0, #1
-	3.0 mm
⊕	3.0 mm
Pentalobe ⦿ P2, P5, P6 (iPhone, MacBook Air, MacBook Pro)	
6 pcs Φ4.0x30 mm, material : 50BV30 Cr-V steel	
⊙	2.5, 3.0, 3.5, 4.0, 4.5, 5.0 mm
5 pcs Φ1/4"(6.3)x25 mm, material : AISI 6150 Cr-V steel	
+	#2
-	6.0 mm
⊙	4.5, 5.0, 6.0 mm
2 pcs Φ1/4"(6.3)x38mm, material : AISI 6150 Cr-V steel	
Torx plus® socket ⦿ TS3.8, TS4.5	
1 pc Φ4.0mm to Φ1/4" adaptor 50 mm	
1 pc Φ4.0x125 mm extension bar	
1 pc TPR non-slip handle	

Individual packing :Plastic box+color sleeve

⦿ P2、P5、P6 pentalobe tips are special for Apple products.

⦿ TS3.8、TS4.5 Torx plus® sockets are for Nintendo, SEGA products.



For Nintendo video games



For Nintendo, SEGA products



P2, P5, P6 pentalobe tips are special for Apple products



For "Happy Meal" toys



▶ SD-9313 30 IN 1 Video Game Screwdriver Set



Contents	
19pcs hex bits: 4mm hex x 28mm (1.1"), Material: AISI 8660 Cr-Mo-V steel	
+	#000, #00, #0
-	2.0, 3.0, 5.0mm
⊕	T5H, T6H, T8H, T10H, T15H, T20H
⊕	T4
⊙	H0.7
⊕	TRI 1, TRI 0, TRI 00
⊕	1.7, 2.0, 2.3mm
5pcs hex bits: 1/4" x 25mm (1.0"), Material: SAE 6150 Cr-V steel	
-	4.0, 5.0, 6.0mm
+	#1, #2
4pcs Nut & Torx plus socket, Material: SAE 6150 Cr-V steel	
⦿	TS3.8, TS4.5(L:38mm/1.5")
⦿	6mm, 8mm (L:36mm/1.4")
3 position ratchet handle: 135mm/5.3"	
ø4mm to ø1/4" adaptor: 45mm /1.8"	
Extension bar: 115mm /4.5"	
Carrying case : 205x126x34mm /8"x5"x1.3"	

Individual packing: Color box



SD-9315 22 In 1 Precision Screwdriver Set



- With extension bar design, ideal for accessing fasteners in tight areas
- Bits with color-coded for easy identification and management
- Durable compact size storage box for easy bits collection and carrying
- Ideal for mobile phone, PDA, PC & other applications.



Contents		
● 2.5/3.0/3.5/4.0/4.5/5	⊕ PH1/PH0/PH00/PH000	4mm
⊖ 1.0/1.5/2.0/2.5/3.0	⊗ T4/T5/T6/T7/T8	
Extension bar: 4mm x 70mm		1pc Dual color PP+TPR handle
Carrying case: 130x86x29mm/5.1"x3.38"x1.1"		

Individual packing: Blister Card

SD-9316 23 In 1 High Performance Screwdriver Set



- Bits with color-coded for easy identification and management
- Durable compact size storage box for easy bits collection & carrying
- Ideal for mobile phone, PDA, PC & other applications.



Contents		
● H2/H3/H4/H5	⊕ PH1/PH0/PH00	4mm
⊗ T15H/T20H/T25H	⊖ 1.5/2.0/2.5	
⊖ 6/8/10	⊗ T4/T5/T6/T7	
Extension bar: 4mm x 70mm, 1/4" x 70mm		1pc Anodized aluminum alloy handle
Carrying case: 130x86x29mm/5.1"x3.38"x1.1"		

Individual packing: Blister Card

SD-9802 31 IN 1 Precision Electronic Screwdriver Set



- Smooth rotating cap for quick and easy screw/unscrew without lifting from screw
- Ergonomic design with non-slip and dual color TPR handle for operator comfort
- Keyless chuck for easy adjustment of bits holder extension bar



(Storage box size: 212x142x30mm/ 8.3"x5.6"x1.2")

Contents		
TPR non-slip handle: 115mm/4.5"		
Extension bar :110mm /4.3"		
30pcs hex bits: 4mm hex x 28mm (1.1"), Material: S2 steel		
⊕ PH00, PH0, PH1, PH2	● 0.9, 1.3, 1.5, 2.0, 2.5, 3.0, 4.0mm	
⊗ T4, T5, T6, T7, T8, T10, T15, T20	⊗ 2mm , Pin 1.0mm	
⊖ 1.5, 2, 2.5, 3, 3.5, 4mm	Extension bar: 110mm	
⊖ 3mm, ⊖ 2.6mm, ⊖ 3mm	TPR non-slip handle:115mm/4.5"	
Carrying case: 205x126x34mm / 8"x5"x1.3"		

Individual packing: Double Blister

SD-9804 15 IN 1 Precision Electronic Screwdriver Set



- Ergonomic designs with non-slip and dual color TPR handle for operation comfort.
- 14pcs interchangeable precision bits made of high quality chrome vanadium steel.
- With extension bar design, ideal for accessing fasteners in tight areas



Contents		
TPR non-slip handle: 110mm	Extension bar:110mm	
14pcs hex bits:ø4 x 28mm, Material: AISI 6150 Cr-V steel		
⊕ #00, #00, #0, #1	⊖ 1.5, 2.0, 2.5, 3.0, 4.0mm	⊗ T5, T6, T7, T8, T9
Carry case: 147x95x24mm/5.8"x3.7"x0.9"		

Individual packing: Blister card

SD-3502
6 PC Star Screwdriver Set



Contents	Blade length (mm/inch)
T4	20 mm/0.78"
T5H, T6H, T7H, T8H, T9H	20 mm/0.78"

Carrying case: 121x93x18mm
Individual packing: Plastic box+Color box

800-149
Screwdriver Set



- Rotating cap for fast screw.
- ABS non-slip handle for use comfort.



Contents	Blade length (mm/inch)
#0, #00, #1	20 mm/0.78"
2.0, 2.4, 3.0	20 mm/0.78"

Individual packing: Color box

800-150
Screwdriver Set



- Rotating cap for fast screw.
- ABS non-slip handle for use comfort.



Contents	Blade length (mm/inch)
T5H, T6H, T7H, T10H, T15H, T20H	20 mm/0.78"

Individual packing: Color box

800-007 6 PC Precision Screwdriver Set



Contents	Blade length (mm/inch)
#0 (Ø 2.4)	75/3.0
#1 (Ø 3.0)	100/3.9
#1 (Ø 3.8)	150/5.9
2.4mm	75/3.0
3.0mm	100/3.9
3.8mm	150/5.9

Individual packing: Blister card

800-009 6 PC Precision Screwdriver Set

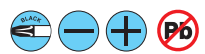

Contents	Blade length (mm/inch)
#000	40/1.6
#00	75/3.0
#0	75/3.0
0.08	40/1.6
0.10"	75/3.0
0.12"	75/3.0

Individual packing: Plastic box + Color label

800-077 6 PC Electronic Screwdriver Set With Cutter

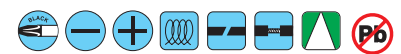

Contents	Blade length (mm/inch)
#1	150/5.9
#0	100/3.9
#0 (Ø 2)	75/3.0
2.4mm	75/3.0
3.0mm	100/3.9
4.0mm	150/5.9

3.5" Stainless micro cutting plier
Individual packing: Plastic box + Color label

MS-3209 3 In 1 F Type
Install/Remove Tool

- Installs and removes F-Type connectors
- Handle contains male F-Type holder
- Flaring function, to make shield braid flared & enlarge space between shield & insulation



Body	Handle	OAL(mm/Inch)
Carbon steel w/ nickel plated	PVC	188/7.4"

800-072/800-079
CATV Install/Extract Tool

- Installs and removes F-Type connectors in hard to reach places
- Handle contains male F-Type holder



Model No.	Material	Handle	HRC	O.A.L (mm/inch)	Individual packing
800-072	Cr-V	PVC	45°±3°	300mm/12"	Polybag+header card
800-079	Cr-V	PVC	45°±3°	150mm/6"	Polybag+header card
800-049	Cr-V	PVC	45°±3°	200mm/8"	Polybag+header card
800-050	Cr-V	PVC	45°±3°	300mm/12"	Polybag+header card

800-049/800-050 BNC Connector Insertion/Removal Tool

- Provides easy access to difficult to reach, high density connectors

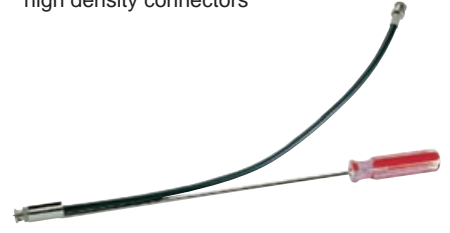

▶ SD-9810A-BC 10 in 1 Auto Loading Ratchet Screwdriver Set



- Precision screwdriver features 3 ways gearless ratchet with twist reverse for efficient operation.
- Pump-action design for easily and quickly auto-loading bits exchange.
- Ergonomically non-slip handle provides user comfort
- Rotatable marked barrel for 6pcs bits pre-loading and storage.
- Includes ten high quality AISI 8660 Cr-Mo-V alloy steel bits with satin finish.



Individual packing

Contents	
10 pcs 4mm Hex screwdriver bits	
⊖	1.5, 2.0, 3.0
⊕	#00, #0, #1
⊗	T5, T6, T8, T10



OAL:170mm/6.7"



▶ 800-092/800-092-50 4-In-1 Screwdriver Set

- Two double-ended, reversible tips
- Material: Blade: AISI 6150 Cr-V steel
- HRC: 52°±3°
- Handle: ABS



Offered in 50PC in a display pack and blister pack (individually)

Model No.	Individual packing	Contents	O.A.L (mm/inch)
800-092	Single pc	⊖ 1/16", 1/8" ⊕ #00, #0	131/5.2"
800-092-50	50 pcs display pack	Display box: 213x123x144mm/8.4"x4.8"x5.7"	

▶ SD-804/SD-804-1 5-In-1 Screwdriver With LED Flashlight

- Two double-ended, reversible tips
- Material: Blade: AISI 6150 Cr-V steel
- HRC: 52°±3°
- Handle: ABS



Offered by 50PCS in a display - box

Model No.	Individual packing	Contents	O.A.L (mm/inch)
SD-804	50 pcs display pack	⊖ 1/16", 1/8" ⊕ #00, #0	135/5.3"
SD-804-1	Blister card	Display box: 213x123x144mm/8.4"x4.8"x5.7"	

▶ 800-040 Double-ended Screwdriver

- Pocket clip
- Straight blade on long end
- Phillips on short end



Contents	
⊖	3mm
⊕	#0

Individual packing: Hanger

▶ 900-055 Double End Socket Can Wrench

- Used to place fuses in cable terminals and connect wires to fuses and binding posts.
- 3/8" & 7/16" hex double end. Plastic handle.



Material	Handle	HRC	O.A.L (mm/inch)	Individual packing
S45C	Plastic	45°±3°	180/7.1	Blister card

Pro-Soft Handle Series Screwdrivers

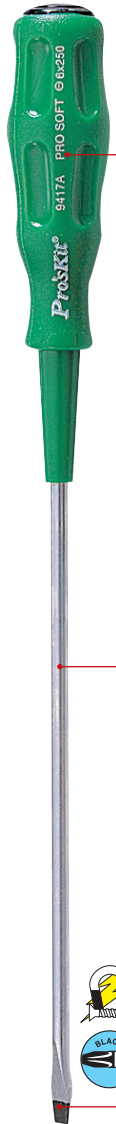
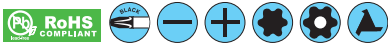

Molded propylene handle

High grade AISI 8660 chrome vanadium steel

Satin finish and black oxide tip



Special inlaid blade insert; safe and durable

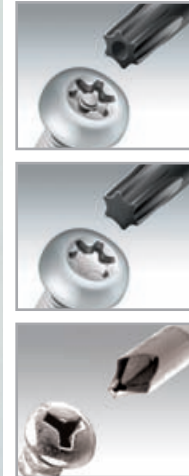

Molded propylene handle

High grade chrome vanadium steel

Satin finish and black oxide tip

Model No.	A	B(mm)	C	D	E
800-001	3	3.2	3.3	1/8	6.3
800-003	3	5.0	4.3	3/16	7.3
800-010	4	3.2	3.3	1/8	7.3
800-012	6	3.2	3.3	1/8	9.3
800-005	2.3	6.0	6.0	1/4	8.3
800-014	4	5.0	4.3	3/16	8.3
800-020	10	5.0	4.3	3/16	14.3
800-022	4.3	6.0	6.0	1/4	10.3
800-024	6.3	6.0	6.0	1/4	12.3
800-018	8	5.0	4.3	3/16	12.3
800-016	6	5.0	4.3	3/16	10.3
800-026	8.3	6.0	6.0	1/4	14.3

Individual packing: Hanger

Model No.	A	B	C	D	E
800-002	3	#0	3.3	1/8	6.3
800-004	3	#1	4.3	3/16	7.3
800-011	4	#0	3.3	1/8	7.3
800-013	6	#0	3.3	1/8	9.3
800-006	2.3	#2	6.0	1/4	8.3
800-015	4	#1	4.3	3/16	8.3
800-021	10	#1	4.3	3/16	14.3
800-023	4.3	#2	6.0	1/4	10.3
800-025	6.3	#2	6.0	1/4	12.3
800-019	8	#1	4.3	3/16	12.3
800-017	6	#1	4.3	3/16	10.3
800-027	8.3	#2	6.0	1/4	14.3

Individual packing: Hanger

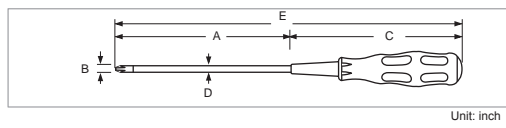

Star-Tip with Tamper-proof holes (Larger sizes)

Model No.	A	B	C	D	E
800-032	2	T5	3.3	5/32	5.3
800-033	2	T6	3.3	5/32	5.3
800-034	2	T7	3.3	5/32	5.3
800-035	3	T8	3.3	5/32	6.3
800-036	3	T9	3.3	5/32	6.3
800-037	3	T10	3.3	5/32	6.3
800-038	3	T15	3.3	5/32	6.3
800-043	2	T7H	3.3	5/32	6.3
800-044	3	T8H	3.3	5/32	6.3
800-045	3	T9H	3.3	5/32	6.3
800-046	3	T10H	3.3	5/32	6.3
800-047	3	T15H	3.3	5/32	6.3

Individual packing: Hanger

Tri-wing Type Screwdriver

Model No.	A	B	C	D	E
800-123	2	TRI	3.3	1/8	5.3

Individual packing: Blister card

SW-2125H 5 PC Star Screwdriver Set



Contents

T05H, T06H, T07H, T08H, T09H

Individual packing: Blister card

800-030 11 PC Star Screwdriver Set



Contents

T6, T7, T8, T9, T10, T15, T20, T25, T27, T30, T40

Carrying case: 310x230x50 mm
12.2"x9.1"x2"

Individual packing: Inner box + Color label shrink

Ergonomic Cushion Grip Series Screwdrivers/Nut Drivers



Meets the DIN, ISO and ANSI standards.

- Ergonomic and soft cushion handle fits your hand and provides best comfort and firm grip for users.
- Acetate and TPV materials of handle provide nonslip and resistance to chemical, oil and most solvents.
- The blade of screwdriver is made of special high quality SVCM alloy steel, nut driver is made by CR-V, through-hardened with satin chrome or chrome plating.
- Blade tip ensures a perfect fit in every screw head.
- The screw symbol and tip size marking is on the handle end, easy to find the right screwdriver for the job.

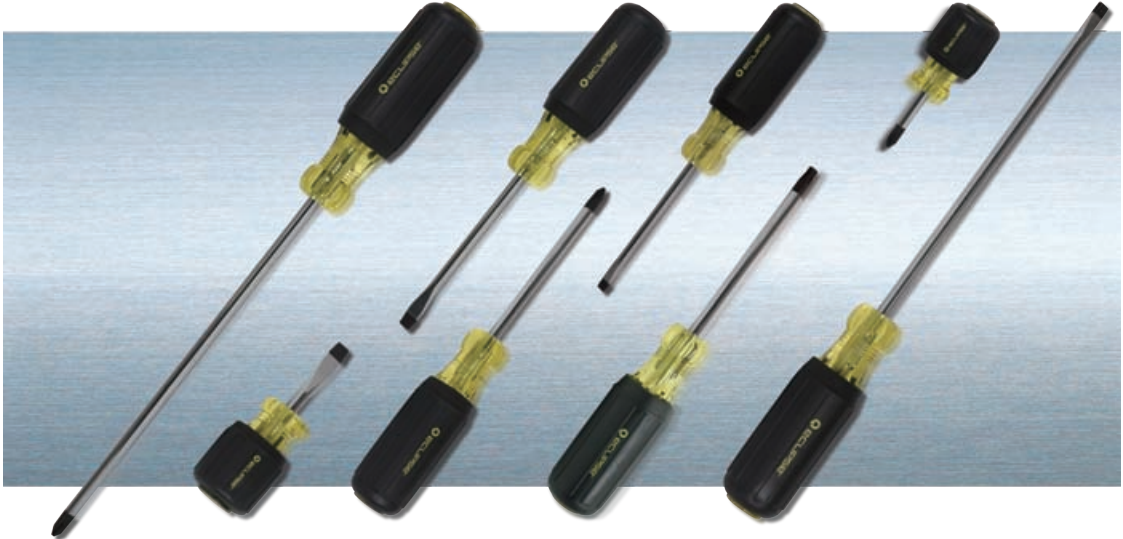

Ergonomic and soft cushion handle

SVCM Alloy steel



Black tip



The screw symbol and tip size marking is on the handle end

— SLOTTED CREWDRIVER

Model No.	SIZE	OAL (inch)
800-097	3/16" X3"	6.69
800-099	3/16" X4"	7.68
800-095	3/16" X 6"	9.65
800-093	1/4" X4"	8.27
800-152	1/4" X 6"	10.24
800-153	1/4" X8"	12.20
800-154	1/4" X10"	14.17
800-101	1/4" X1-1/2"	3.62

+ PHILLIPS SCREWDRIVER

Model No.	SIZE	OAL (inch)
800-098	#1 X 3"	6.69
800-100	#1 X 4"	7.68
800-094	#2 X 4"	8.27
800-103	#2 X 6"	10.24
800-096	#2 X8"	12.20
800-104	#2 X10"	14.17
800-102	#2 X 1-1/2"	3.62

★ STAR TIP SCREWDRIVER

Model No.	SIZE	OAL (inch)
800-109	T15 X 4"	7.68
800-110	T20 X 4"	7.68
800-111	T25 X 4"	8.27
800-112	T27 X 4"	8.27
800-113	T30 X 4"	8.27

■ SQUARE SCREWDRIVER

Model No.	SIZE	OAL (inch)
800-105	S0 X4"	8.27
800-106	S1 X 4"	8.27
800-107	S2 X 4"	8.27
800-108	S3 X 4"	8.27

● HOLLOW-SHAFT NUT DRIVER

Model No.	SIZE	OAL (inch)
902-231	3/16" X 3"	7.28
902-232	1/4" X 3"	7.28
902-233	5/16" X 3"	7.28
902-234	11/32" X 3"	7.28
902-235	3/8" X 3"	7.28
902-236	7/16" X 3"	7.28
902-237	1/2" X 3"	7.87

1PK-9402 7 PC Electronic Hex Nut Driver Set

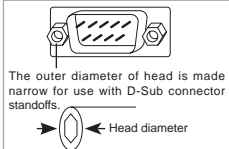

Contents
M3, M3.5, M4, M4.5, M5, M5.5, M6

Individual packing: Pouch

8PK-2066 Interchangeable Screwdriver Set (7 PC)



- Shock proof cellulose acetate plastic handle with circuit testing lamp.
- Range: AC 100~250V.

Contents	
Circuit testing handle, length: 120mm	
6 Pcs bits, length: 125mm material: AISI 6150 Cr-V Alloy steel	
—	3x130
+ / -	5x130
+	No. 1x130
+	No. 2x130
●	5.5x130
▲	AWLx130

Individual packing: Plastic box+Color label



1000V Insulated VDE Screwdrivers and Insulated VDE Nut Driver



- Certified to IEC 60900: 2004, VDE, and DIN 1000V safety standards and bear the GS sign.
- High visibility molded ergonomic cushion grip handles for maximum comfort.
- The insulation of the handle is molded directly onto the blade for permanent bonding.



High visibility molded ergonomic cushion grip handles

Heavy insulated shank

AISI 8660 Cr-Mo-V alloy steel
HRC:55'±2'



Dual color PP + TPR ergonomic cushion grip handles

Heavy insulated shank

Heavy duty deep head blade

Model No.	Spec.	Blade length (mm/inch)
902-212	⊖ 0.4x2.5mm	75/3
SD-800-S3.0	⊖ 0.5x3.0mm	100/4
902-214	⊖ 0.8x4.0mm	100/4
SD-800-S5.5	⊖ 1.0x5.5mm	125/5
902-216	⊖ 1.2x6.5mm	150/6
902-217	⊖ 1.2x8.0mm	175/7
902-209	⊕ PH0	60/2.4
902-210	⊕ PH1	80/3.2
902-211	⊕ PH2	100/4
902-220	⊕ PH3	150/6

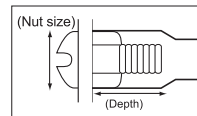

Model No.	Nut size (mm) & depth(mm)	Blade length (mm/inch)
SD-800-I8	⊖ 1/4" x 1"	125/4.9
SD-800-I9	⊖ 5/16" x 1"	125/4.9
SD-800-I11	⊖ 3/8" x 1"	125/4.9

Individual packing: Double blister card

902-213 Insulated Screwdrivers Set



- 7 piece set. VDE safety screwdriver set with Cr-Mo-V alloy.
- Steel AISI: 8660 blade.
- This essential kit is a must when working with electrical items.
- Supplied in a case.

Contents
S2.5, S3.0, S5.5, S6.5, PH0, PH1, PH2
Carrying case : 310x230x50mm 12.2"x9.1"x2.0"

Individual packing:
Inner box+Color label shrink

▶ **902-215** 8 PC 1000V Insulated Screwdriver & Plier Set



Contents	
⊖	0.4x2.5x75mm (3")
⊖	0.5x3.0x100mm (4")
⊖	1.0x5.5x125mm (5")
⊕	PH1x80mm (3.1")
⊕	PH2x100mm (4")
	6.3" Insulated wire stripping plier
	6.3" Insulated side cutter
	6.3" Insulated long nose plier
	Zippered carrying bag

- Case size: 255x175x50/10.0x6.9x2.0 (mm/inch)
- Individual packing: Inner box & Color label shrink

▶ **902-218** 11 PC 1000V Insulated Plier & Screwdriver Set



Contents	
⊖	0.4x2.5x75mm (3")
⊖	0.8x4.0x100mm (4")
⊖	1.0x5.5x125mm (5")
⊖	1.2x6.5x150mm (6")
⊕	PH0x60mm (2.4")
⊕	PH1x80mm (3.1")
⊕	PH2x100mm (4")
	7.9" Insulated combination plier
	6.3" Insulated side cutter
	7.9" Insulated long nose plier
	6.3" Insulated long nose plier
	Zippered carrying bag

- Case size: 294x240x50 / 11.6x9.4x2.0(mm/inch)
- Individual packing: Inner box & Color label shrink

▶ **902-099** 6 PC Insulated Precision Screwdriver Set



- Provides shock protection to 1000V AC
- Meet VDE standards for safety to 1000V AC
- Comes complete with a plastic storage case
- Material (Blade): Cr-Mo

Contents	O.A.L.(mm/inch)
⊖ 0.4x2.0x65mm(2.6")	165/6.5"
⊖ 0.23x1.5x65mm(2.6")	165/6.5"
⊖ 0.4x2.5x65mm(2.6")	165/6.5"
⊕ PH00x65mm(2.6")	165/6.5"
⊕ PH0x65mm(2.6")	165/6.5"
⊕ PH1x65mm(2.6")	165/6.5"
Carrying case : 195x184x28mm/ 7.7"x7.2"x1.1"	

Individual packing: Shrink



SD-2404 4PC Security Screwdriver Set



Fast turning swivel cap for easy operation

Dual color TPR and PP non-slip handle

Made of AISI 8660 Cr-Mo-V steel with Cr plating for antirust HRC:55 ±2



- Made of Cr-Mo-V steel with chromium (Cr) plating for anti-rust
- Special inlaid blade molded into dual color TPR and PP non-slip handle provides high torque and user comfort.
- Fast turning swivel cap for easy operation.

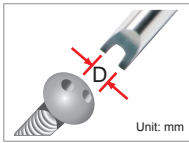

Contents		
4pcs Security Screwdriver Set.		
D	O.A.L.(mm/inch)	
1.5mm	165/6.5"	
2.3mm	165/6.5"	
2.5mm	165/6.5"	
3.1mm	165/6.5"	

Individual packing: Blister card

Go Through Series Screwdrivers

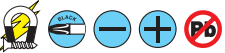

Elastomeric resin, double structure, Non-slip.
Ergonomically designed handle provides comfort and power
Black: TPR
Orange: PP

Hex shaft increases extra torque.

High grade AISI 6150 Cr-V steel hex blade HRC: 52° ± 2°

Black oxide magnetic tip for greater fastener control



The hex shaft and bolster fit any brand of wrench which can loosen tight screws easily.



The steel cap withstands hammer blows

- "Go-Through" construction provides greater striking force than traditional cap end.
- The hex shaft and bolster fit any brand of wrench which can loosen tight screws easily.
- Black oxide magnetic tip for greater fastener control and guarantees a perfect fit every time.



Toughest Ergonomic More turning power

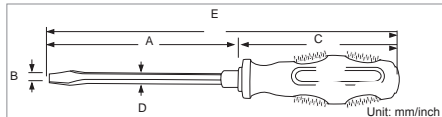

Individual packing: Hanger

Model No.	A (mm/inch)	B	C (mm/inch)	D (mm/inch)	E (mm/inch)
SD-7213A	150/5.9	6.0mm	109/4.3	6/0.23	259/10.2
SD-7213B	150/5.9	#2	109/4.3	6/0.23	259/10.2
SD-7222A	150/5.9	8.0mm	121/4.8	8/0.31	271/10.7
SD-7222B	150/5.9	#3	121/4.8	8/0.31	271/10.7

902-096/902-097 Pro-soft Screwdriver Set



Elastomer resin fitting exactly and double structure. Non-slip.



Model No.	Contents	
902-096	3.0x75mm(3"), 5x75mm (3"), 6x100mm (4")	#0x75mm(3"), #1x75mm(3"), #2x100mm(4")
902-097	T5HX50mm(2"), T6HX50mm(2"), T7HX50mm(2"), T8HX50mm(2")	T9HX50mm(2"), T10HX75mm(3"), T15HX75mm(3")

Individual packing: Color box

800-028/800-029 Stubby Screwdrivers



New design fits your hand shape, provides comfortable and powerful grip.

High grade chrome-molybdenum vanadium steel.

Exact fit to screws and high accuracy hardened finish.



Model No.	Contents
800-028	6.0x40mm (1.6")
800-029	#2x40mm (1.6")

SD-9817 6 In 1 Ratchet Screwdriver Set



- Pivoting head locks in 3 operating positions allowing better control & access to confined areas.
- Ergonomic dual color TPR+PP handle with bits storage inside.
- Magnetized hex opening holds all standard driver bits, and allows quick removal and replacement.
- 3 position ratchet features forward, reverse and locked.



Contents	
6 pcs 1/4" Bits:	
⊖ 4,5,6mm	⊕ #1, #2, #3
1 pcs 3-way ratchet screwdriver handle	
Individual packing: Blister card	

8PK-SD010 12-In-1 Ratchet Screwdriver Set

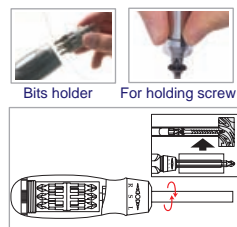

Contents	
Dual color TPR non-slip ratchet handle	
12pcs ø1/4"x30mm bits:	
⊖ T6, T7, T8, T9, T10, T15	
⊕ #0, #1, #2	
⊖ 3, 4.7, 6.3	
Individual packing: Blister card	



SD-2313 30 PC Do-It-All Kit



- Triangle magnetic bits storage case with a hanger.
- Magnetic extension handle.
- Compact and versatile set of bits.



Magnetic storage case Triangle bits case



Bits	
TPR non-slip handle with bits holder 0Pcs hex bits: ø1/4" x 25mm/1", Material: SAE 6150 Cr-V steel	
⊖ SQ1, SQ2	
⊕ #0, #1, #2, #3	
⊕ PZ0, PZ1, PZ2, PZ3	
⊖ SL3.5, 4.5, 5.5, 6, 8mm	
⊕ HX2, 2.5, 3, 4, 5, 6, 8	
⊖ T5, T6, T7, T8, T10, T15, T20, T35	
Individual packing: Hanger	

800-080 6 In 1 Magnetic Quick Change Screwdriver



- Industrial quality with maximum versatility.
- Shock proof T.P.R + P.P. and S2 alloy steel bit.
- O.A.L: 200mm/7.9"



Flash interchangeable Double ended socket



Contents	
Dual color TPR non-slip handle 125mm/4.9"	
3pcs double end bits and socket:	
⊖ 8mm socket x115mm/4.5"	
⊖ 6mm socket x115mm/4.5"	
⊖ 3/16", 1/4" x75mm/3.0"	
⊕ #1, #2 x75mm/3.0"	
Individual packing: Blister card	

800-041/800-042 Pocket Clip Screwdriver

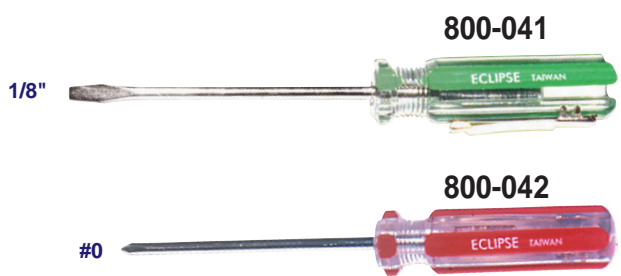

Model No.	Spec.
800-041	⊖ 3x135mm (5.31")
800-042	⊕ #0x135mm (5.31")

Individual packing: Hanger

800-148 Double-end Reversible Screwdriver



Material	HRC	Handle (mm/inch)	Blade (mm/inch)	Working length (mm/inch)
AISI 6150	48 ±3°	108/4.3	125/4.9	100/39"

Individual packing: Blister card

▶ 800-068 Twin Wrench Driver Set



Contents	
Both end handle 110mm/4.3"	
10pcs 4mm hex x30mm/1.2" AISI 6150 Cr-V steel bits:	
⊖ 4, 5, 6	⊕ PZ1, PZ2
⊕ #1, #2	⊖ T10, T15, T20



Tips at both ends for horizontal & vertical use.

Individual packing: Blister card

▶ 800-076 Flexible Ratchet Driver Set

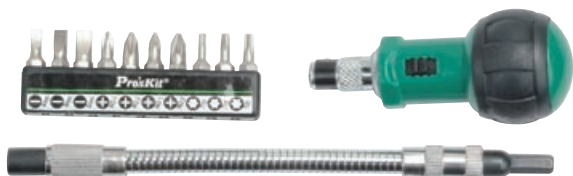

Contents	
10pcs $\varnothing 1/4"$ x30mm/1.2" AISI 6150 Cr-V steel bits:	
⊖ 4, 5, 6	⊕ PZ1, PZ2
⊕ #1, #2	⊖ T10, T15, T20



Flexible shaft gets into hard to reach areas.

Individual packing: Blister card

▶ 800-048/800-048E 33 PC Security Bit Set



- Available in lower quality SAE 6150 CR-V steel for a lower price-part#: 800-048E
- 800-048 Material: S2 alloy steel bits

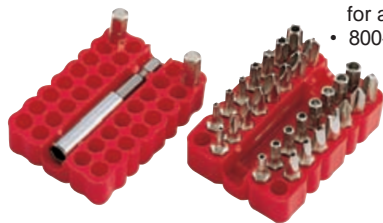

Spec.	Spec.	Contents
⊖ 5/64", 3/32", 7/64", 1/8", 9/64", 5/32", 3/16", 1/4"	⊖ 4, 6, 8, 10	1/4" Magnetic extension bar 60mm/2.4"
	⊕ 6, 8, 10	
⊖ T8H, T10H, T15H, T20H, T25H, T27H, T30H, T35H, T40H	⊕ 1, 2, 3, 4	32pcs 1/4" hex x30mm(1.2") bits
	⊕ 1, 2, 3, 4	

Individual packing: Blister card

▶ 900-194 23 PC 1/4" Drive Socket Set



▶ 902-069 Twin Wrench Driver Set



Contents	
Both end handle 110mm/4.3"	
8pcs $\varnothing 1/4"$ x30mm/1.2" AISI 6150 Cr-V steel bits:	
⊖ T6	⊖ T8H, T10H, T15H, T20H, T25H, T27H, T30H
2pcs $\varnothing 1/4"$ x37mm/1.5" AISI 6150 Cr-V steel double end bits:	
⊕ #1 - ⊖ 4.5	⊕ #2 - ⊖ 6.0



Tips at both ends for horizontal & vertical use.

Individual packing: Blister card

▶ 800-078 17 PC Offset Ratchet & Socket Drivers Set



2-way ratchet design for forward and reverse rotation.

Contents			
1pcs 2-way ratchet handle, 6pcs sockets($\varnothing 1/4"$ x 25mm/1", AISI 6150 Cr-V):			
⊖ 3/8", 11/32", 5/16", 1/4", 7/32", 3/16" (Inch size)			
10pcs bits($\varnothing 1/4"$ x30mm/1.2", AISI 6150 Cr-V):			
⊖ 4, 5, 6mm	⊕ #1, #2	⊕ PZ1, PZ2	⊖ T10, T15, T20

Individual packing: Blister card

▶ 800-039 20 in 1 Screwdriver With Telescoping Pick-Up Tool



- (A) Regular screwdriver with 13 pcs. screw bits 5 pcs. sockets and 1 pcs socket adaptor fits all kinds of job.
- (B) Telescoping magnetic pick-up tool (up to 17-1/2" long/440mm) stored inside the tube pulling out to pick up small metal objects.



Individual packing

Blister card

Magnetic pick-up: 250g(Max.)

Contents	
⊖	18 pcs 1/4" DR 4, 5, 6, 7, 8, 9, 10, 11, 12mm 3/16", 7/32", 1/4", 9/32", 5/16", 11/32", 3/8", 7/16", 1/2"
140mm (5.5") ratchet handle	
Adaptor: 70mm(2.8"), 145mm(5.7")	
Steel box (214x84x44mm)/(8.4"x3.3"x1.7")	
Individual Packing : Color Sleeve Shrink	

▶ SD-2318M 27 PC 1/4" Drive Socket & Screwdriver Set



- 72 teeth 2-way ratchet stainless steel handle for easy rotating operation
- Mini size gets into smaller and tighter spots easily
- Bits come with color ring for easy specification identification
- Covers most common use bits and sockets
- EVA tray complied with RoHS standard
- Compact box with hanger design for easy carrying and storage



Contents	
5pcs 1/4" Drive socket:	6, 7, 8, 10, 12mm
18pcs 1/4" Bits:	⊖ 3.0, 4.0, 5.0, 6.0mm, ⊕ #1, #2, #3, ⚙ H3.0, H4.0, H5.0, H6.0 ⊕ PZ1, PZ2, PZ3, ⚙ T10, T15, T20, T25
Magnetic Bit Adaptor: 60mm(L) / 2.4"	
1pcs 1/4" Hex(male) to 1/4" socket(male) adaptor, 1/4" square drive(female) to 1/4" hex bit holder, 1/4" 72 Teeth stainless reversible ratchet handle	
Carrying case: 84x39.5x129mm/3.3"x1.6"x5.1"	
Individual packing: Blister card	

▶ SD-2319M 22 PC Palm Ratchet Wrench Bit & Socket Set

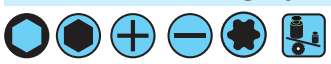

- Faster than a ratcheting wrench, the palm ratchet for easy operate in limited areas.
- Combine with ergonomic aluminum handles provides maximum speed and torque
- Compact size, durable plastic box for easy carrying and storage
- Covering most common use bits and sockets to meet most applications



Aluminum handles provides maximum speed and torque
The palm ratchet for easy operate in limited areas

Contents	
5pcs 1/4" Drive socket:	⚙ 5, 6, 7, 8, 10mm
14pcs 1/4" Bits:	⊖ 3.0, 4.0, 6.0mm, ⊕ #1, #2, #3, ⚙ T10, T15, T20, ⚙ H2.5, H3.0, H4.0, H5.0, H6.0
1/4" Hex(male) to 1/4" socket(male) adaptor	Extension handle for palm ratchet
1/4" Drive aluminum palm ratchet	Carrying case 126x82x30mm/5.0"x3.2"x1.2"
Individual packing: Blister card	

▶ 800-081 62 PC Security Bit Set



Materials: SAE 6150 Cr-V Steel
Light weight design: 575g

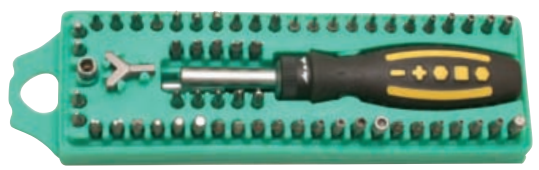

Contents		
⚙ M5, M6, M8	⊖ C1, C2, C3	⊕ 6, 8, 10
⊖ 1/8", 3/16"	⚙ TA2.0	⊖ 4, 6, 8, 10, 12
⊖ S0, S1, S2, S3	⚙ 1, 2, 3, 4, 5	⊕ PZ0, PZ1, PZ2
⊕ #0, #1, #2	⊖ Wing nut driver	
⚙ T-5H, T-6H, T-7H, T-8H, T-9H, T-10H, T-15H, T-20H, T-25H, T-27H, T-30H, T-40H		
⚙ 2, 2.5, 3, 4, 5, 6, 8mm, 5/64", 3/32", 7/64", 1/8", 9/64", 5/32"		
1 pc socket adapter	1 pc 1/4" x 60mm(2.36") magnetic bits holder	
1 pc bits holder socket	1 pc ratchet screwdriver (190mm/7.5")	

Case: 256x80x43mm/10.1"x3.1"x1.7" Individual packing: Shrink packing

▶ SD-2310 100 PC Assorted Power Bits Set



Materials: SAE 6150 Cr-V Steel
Light weight design: 699g

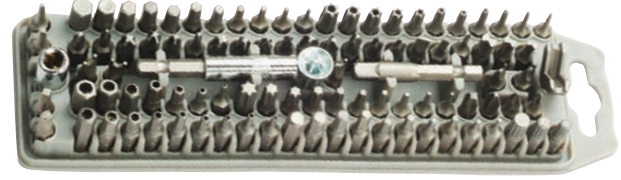

Contents		
⊕ PH1, PH2	⊕ PH0, PH1, PH2, PH3	
⊖ C1, C2, C3	⊖ S0, S1, S2, S3	
⚙ 1, 2, 3, 4, 5	⊕ 6, 8, 10	
⊕ PZ0, PZ1, PZ2, PZ3	⚙ TA2.0	
⚙ M5, M6, M8	⊖ 2, 3, 5mm	
⊖ 4, 6, 8, 10, 12	⊖ Wing nut driver	
⚙ 1.5mm, 2mm, 2.5mm, 3mm, 4mm, 4.5mm, 5mm, 5.5mm, 6mm, 7mm, 8mm, 1/16", 5/64", 3/32", 7/64", 1/8", 9/64", 5/32", 3/16", 7/32", 1/4"		
⚙ 2, 3, 4, 5, 6, 7, 8mm, 5/64", 3/32", 7/64", 1/8", 9/64", 5/32", 3/16", 7/32", 1/4"		
⚙ T5H, T6H, T8H, T10H, T15H, T20H, T25H, T27H, T30H, T35H, T40H		
⚙ T5, T6, T8, T10, T15, T20, T25, T27, T30, T40		
1 pc sockets adapter, 1 pc bits holder, 1 pc dry wall stopper, 1 pc magnetic bit holder		

Individual packing: Color sleeve + Shrink pack

1/4 Inch Hex High Quality Bits

1/4 Inch Hex High Quality Bits

- High quality bits at an economical price
- Made from S-2 tool steel with a hardness of HRC 59~61°

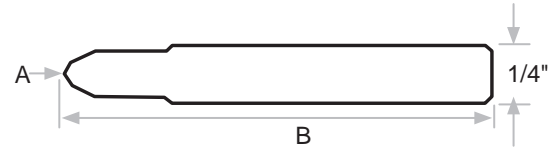

1/4" INCH HEX HIGH QUALITY BITS

▶ Phillips Bits (1/4" Hex drive insert bits)



PART NO.	A	B
PH0X1-15/16	#0	1-15/16"
PH1X1-15/16	#1	1-15/16"
PH2X1-15/16	#2	1-15/16"
PH3X1-15/16	#3	1-15/16"

▶ Phillips Bits (1/4" Hex drive insert bits)



PART NO.	A	B
PH0X1	#0	1"
PH1X1	#1	1"
PH2X1	#2	1"
PH3X1	#3	1"

▶ Slotted Bits (1/4" Hex drive insert bits)



PART NO.	A	B
SL12X1-15/16	1-2	1-15/16"
SL23X1-15/16	2-3	1-15/16"
SL34X1-15/16	3-4	1-15/16"
SL45X1-15/16	4-5	1-15/16"
SL56X1-15/16	5-6	1-15/16"
SL68X1-15/16	6-8	1-15/16"
SL810X1-15/16	8-10	1-15/16"
SL1012X1-15/16	10-12	1-15/16"
SL1214X1-15/16	12-14	1-15/16"

▶ Pozidrive Bits (1/4" Hex drive insert bits)



PART NO.	A	B
PZ0X1-15/16	0	1-15/16"
PZ1X1-15/16	1	1-15/16"
PZ2X1-15/16	2	1-15/16"
PZ3X1-15/16	3	1-15/16"
PZ4X1-15/16	4	1-15/16"

▶ Star-Tip Bits (1/4" Hex drive insert bits)



PART NO.	A	B
T5X1	T-5	1"
T6X1	T-6	1"
T7X1	T-7	1"
T8X1	T-8	1"
T9X1	T-9	1"
T10X1	T-10	1"
T15X1	T-15	1"
T20X1	T-20	1"
T25X1	T-25	1"
T27X1	T-27	1"
T30X1	T-30	1"

▶ Star-Tip Bits (1/4" Hex drive insert bits)



PART NO.	A	B
T5X1-15/16	T-5	1-15/16"
T6X1-15/16	T-6	1-15/16"
T7X1-15/16	T-7	1-15/16"
T8X1-15/16	T-8	1-15/16"
T9X1-15/16	T-9	1-15/16"
T10X1-15/16	T-10	1-15/16"
T15X1-15/16	T-15	1-15/16"
T20X1-15/16	T-20	1-15/16"
T25X1-15/16	T-25	1-15/16"
T27X1-15/16	T-27	1-15/16"
T30X1-15/16	T-30	1-15/16"

▶ Tamper Resistant Star-Tip Bits



PART NO.	A	B
T7HX1	T-7H	1"
T8HX1	T-8H	1"
T9HX1	T-9H	1"
T10HX1	T-10H	1"
T15HX1	T-15H	1"
T20HX1	T-20H	1"
T25HX1	T-25H	1"
T27HX1	T-27H	1"
T30HX1	T-30H	1"

▶ Tamper Resistant Star-Tip Bits



PART NO.	A	B
T7HX1-15/16	T-7H	1-15/16"
T8HX1-15/16	T-8H	1-15/16"
T9HX1-15/16	T-9H	1-15/16"
T10HX1-15/16	T-10H	1-15/16"
T15HX1-15/16	T-15H	1-15/16"
T20HX1-15/16	T-20H	1-15/16"
T27HX1-15/16	T-27H	1-15/16"
T30HX1-15/16	T-30H	1-15/16"

▶ Special Penta-lobe Security Star Tip



PART NO.	A	B
TS10HX1	TS10H	1"
TS15HX1	TS15H	1"
TS20HX1	TS20H	1"

▶ Spanner Security Bits



PART NO.	A	B
SSP4X1	#4	1"
SSP6X1	#6	1"
SSP8X1	#8	1"
SSP10X1	#10	1"
SSP12X1	#12	1"

▶ Robertson Bits

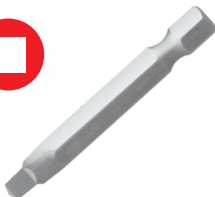

PART NO.	A	B
S1X1-15/16	2.5mm	1-15/16"
S2X1-15/16	3mm	1-15/16"
S3X1-15/16	3.5mm	1-15/16"
S4X1-15/16	4mm	1-15/16"

▶ Robertson Bits



PART NO.	A	B
S1X1	2.5mm	1"
S2X1	3mm	1"
S3X1	3.5mm	1"
S4X1	4mm	1"

For Distributors/Retailers

Power Bits with Spinner Rack

- Quality power bits that customers will want to have on hand
- Excellent price point and variety encourages multiple purchases
- Eye catching packaging



PART NO. BITASST1:

Display Contains 1/4" Hex Assortment

3 EACH:		
902-373	4 PC	Flat Blade, 1-15/16": 1-2, 3-4, 5-6, 8-10 mm
902-374	4 PC	Star-Tip 1": T5, T10, T20, T30
902-375	4 PC	Star-Tip 1-15/16": T5, T10, T20, T30
902-376	4 PC	Tamper Proof Star-Tip 1": T7H, T10H, T20H, T30H
902-377	4 PC	Tamper Proof Star-Tip: T10H, T15H, T20H, T30H
902-379	11 PC	Jumbo Star-Tip 1-15/16": T5, T6, T7, T8, T9, T10, T15, T20, T25, T27, T30
902-380	4 PC	Spanner Security Bits 4, 6, 8, 10
902-381	8 PC	Pozidrive 1-15/16": 0, 1, 2, 3, 4 & Tamper Proof Penta-lobe Star-Tip
6 EACH:		
902-372	4 PC	Phillips 1": 0, 1, 2, 3
902-378	12 PC	Jumbo Pack 1-15/16": Phillips 0, 1, 2, 3, Flat Blade 1-2, 3-4, 6-8, 10-12 mm, Star-Tip T10, T20, T25, T30

Rotating Display
21" H x 12" Diameter



BITASST1
Reorder complete rack refills.
Use part no. **BITASST2** or individually as needed.

1/4" INCH HEX HIGH QUALITY BITS

▶ Hex Head Bits (1/4" Hex drive insert bits)

PART NO.	S.A.E.	
	A	B
HX1/16X1	1/16"	1"
HX5/64X1	5/64"	1"
HX3/32X1	3/32"	1"
HX7/64X1	7/64"	1"
HX1/8X1	1/8"	1"
HX9/64X1	9/64"	1"
HX5/32X1	5/32"	1"
HX3/16X1	3/16"	1"
HX7/32X1	7/32"	1"
HX1/4X1	1/4"	1"



▶ Hex Head Bits (1/4" Hex drive insert bits)

PART NO.	S.A.E.	
	A	B
HX1/16X1-15/16	1/16"	1-15/16"
HX5/64X1-15/16	5/64"	1-15/16"
HX3/32X1-15/16	3/32"	1-15/16"
HX7/64X1-15/16	7/64"	1-15/16"
HX1/8X1-15/16	1/8"	1-15/16"
HX9/64X1-15/16	9/64"	1-15/16"
HX5/32X1-15/16	5/32"	1-15/16"
HX3/16X1-15/16	3/16"	1-15/16"
HX7/32X1-15/16	7/32"	1-15/16"
HX9/32X1-15/16	9/32"	1-15/16"
HX1/4X1-15/16	1/4"	1-15/16"



▶ Ball Hex Head Bits

PART NO.	S.A.E.	
	A	B
BHX5/64X3-1/2	5/64"	3-1/2"
BHX3/32X3-1/2	3/32"	3-1/2"
BHX7/64X3-1/2	7/64"	3-1/2"
BHX1/8X3-1/2	1/8"	3-1/2"
BHX9/64X3-1/2	9/64"	3-1/2"
BHX5/32X3-1/2	5/32"	3-1/2"
BHX3/16X3-1/2	3/16"	3-1/2"
BHX7/32X3-1/2	7/32"	3-1/2"
BHX1/4X3-1/2	1/4"	3-1/2"



▶ Hex Head Bits (1/4" Hex drive insert bits)

PART NO.	metric	
	A	B
HX1.5X1	1.5mm	1"
HX2X1	2mm	1"
HX2.5X1	2.5mm	1"
HX3X1	3mm	1"
HX4X1	4mm	1"
HX5X1	5mm	1"
HX6X1	6mm	1"
HX7X1	7mm	1"



▶ Ball Hex Head Bits

PART NO.	metric	
	A	B
BHX2X3-1/2	2mm	3-1/2"
BHX2.5X3-1/2	2.5mm	3-1/2"
BHX3X3-1/2	3mm	3-1/2"
BHX4X3-1/2	4mm	3-1/2"
BHX5X3-1/2	5mm	3-1/2"
BHX6X3-1/2	6mm	3-1/2"



▶ Assortment Packs

902-390	4 PC	Robertson, S1, 2, 3, 4, 1"
902-391	4 PC	Robertson, S1, 2, 3, 4, 1-15/16"
902-392	8 PC	4 PC Robertson, S1, 2, 3, 4, 1"; 4 PC Robertson, S1, 2, 3, 4, 1-15/16"
902-393	5 PC	Spanner Security Bits 4, 6, 8, 10, 12





HEX KEY WRENCHES



▶ **800-124/800-066 7 PC Folding Hex Key Set**

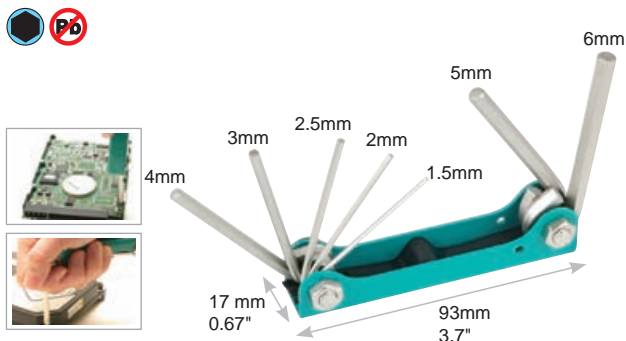

Model No.	Contents	
800-124	● 1.5, 2, 2.5, 3, 4, 5, 6mm (Metric size)	
800-066	● 1/16", 5/64", 3/32", 1/8", 5/32", 3/16", 1/4" (Inch size)	
Key Material	Case	Individual packing
SAE6150 with Satin finish	Green lacquered	Blister card

▶ **800-052 8 PC Folding Star Key Set**

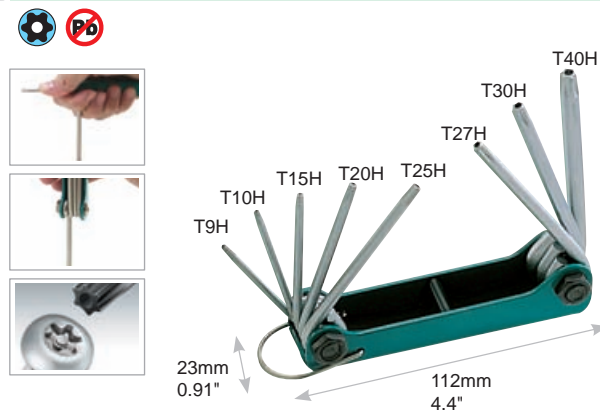

Contents		
● T9H, T10H, T15H, T20H, T25H, T27H, T30H, T40H		
Key Material	Case	Individual packing
SAE 8660 with Satin finish	Green lacquered	Blister card

▶ **902-100 8 PC Folding Star Key Set**



Contents			
● T9H, T10H, T15H, T20H, T25H, T27H, T30H, T40H			
Key Material	Case	OAL. (mm/inch)	Individual packing
SAE 6150 with Satin finish	T.P.R. Anti-slip	109x43x23 4.3"x1.7"x1"	Hanger

▶ **902-226 9 PC Folding Hex Key Set**

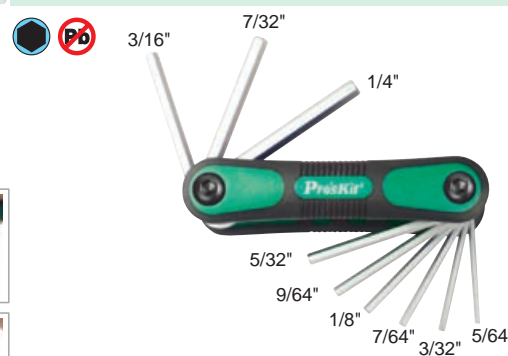

Contents		
● 5/64", 3/32", 7/64", 1/8", 9/64", 5/32", 3/16", 7/32", 1/4" (Inch size)		
Key Material	Case	Individual packing
SAE 6150 with Satin finish	T.P.R. Anti-slip	Hanger

▶ **HW-928 1/2" T-Handle Hex Key**

- Long reach design with T-handle for greater torque and ease of use
 - Hardened S2 steel alloy
- Individual packing: Hanger



▶ **800-091 7 PC T-Handle Hex Key Set**

- Long reach design with T-handle for greater torque and ease of use
 - Hardened S2 steel alloy
 - Set comes in a durable blow-molded case
 - 3/32", 1/8", 5/32", 3/16", 1/4", 5/16" and 3/8"
- Individual packing: Shrink wrap



HW-229B 9 PC Ball Point Long Arm Hex Key Set

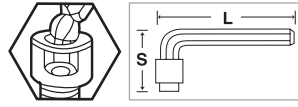

Tip size(mm)	S (mm/inch)	L (mm/inch)
1.5	15.5/0.61	63.5/2.5
2	18/0.71	76/3.0
2.5	20.5/0.81	85.5/3.4
3	23/0.91	91/3.6
4	29/1.1	102/4.0
5	33/1.3	118/4.6
6	38/1.5	139/5.5
8	44/1.7	155/6.1
10	50/1.9	177/6.9
Key Material		SAE 6150 with Satin finish

Individual packing: Blister card

902-101 16 PC Hex Key Wrench Set



- Material: SAE6150 chrome vanadium steel
- Portable packaging.
- Case can be hung for storage or display

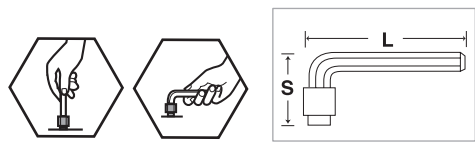

Tip size(mm)	S (mm/inch)	L (mm/inch)	Tip size(inch)	S (mm/inch)	L (mm/inch)
1.5	14/0.55	45/1.8	1/16"	14/0.55	46/1.8
2	16/0.62	51/2.0	5/64"	17/0.62	48/1.9
2.5	19/0.74	57/2.2	3/32"	17/0.62	52/2.0
3	20/0.78	65/2.6	1/8"	20/0.78	58/2.3
4	24/0.94	70/2.8	5/32"	22/0.86	65/2.6
5	29/1.14	80/3.1	3/16"	25/0.98	72/2.8
5.5	29/1.14	88/3.5	7/32"	28/1.10	77/3.0
6	33/1.3	94/3.7	1/4"	29/1.14	86/3.4

Individual packing: Blister card

900-038 30 PC Metric & Inch Combination Hex Key Set



- Material: SAE6150 chrome vanadium steel
- Portable packaging.
- Case can be hung for storage or display

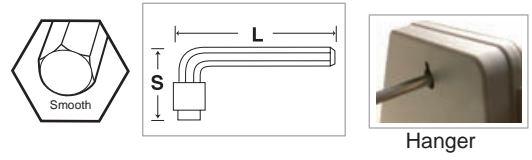

Tip size(mm)	S (mm/inch)	L (mm/inch)	Tip size(inch)	S (mm/inch)	L (mm/inch)
0.7	8/0.31	35/1.4	0.028"	8/0.31	65/2.6
0.9	10/0.39	38/1.5	0.035"	10/0.39	68/2.68
1.3	12/0.47	41/1.6	0.050"	12/0.47	72/2.83
1.5	14/0.55	45/1.8	1/16"	14/0.55	77/3.0
2	17/0.66	50/2.0	5/64"	15/0.59	82/3.23
2.5	19/0.74	56/2.2	3/32"	18/0.70	89/3.5
3	20/0.78	65/2.6	7/64"	18/0.70	93/3.7
4	25/0.98	70/2.8	1/8"	19/0.74	98/3.86
4.5	27/1.06	77/3.0	9/64"	20/0.78	103/4.1
5	29/1.14	81/3.2	5/32"	22/0.87	107/4.21
5.5	31/1.2	86/3.4	3/16"	25/0.98	117/4.6
6	33/1.3	93/3.7	7/32"	28/1.10	127/5.0
7	36/1.4	100/3.9	1/4"	29/1.14	138/5.43
8	37/1.5	103/4.1	5/16"	35/1.4	155/6.1
10	44/1.7	117/4.6	3/8"	36/1.4	177/6.97

Individual packing: Blister card



SOCKET WRENCHES



HW-T Series Adjustable Torque Wrench With Reversible Ratchet

INDUSTRIAL GRADE

DIN ISO 6789

ASME B107.300-2010

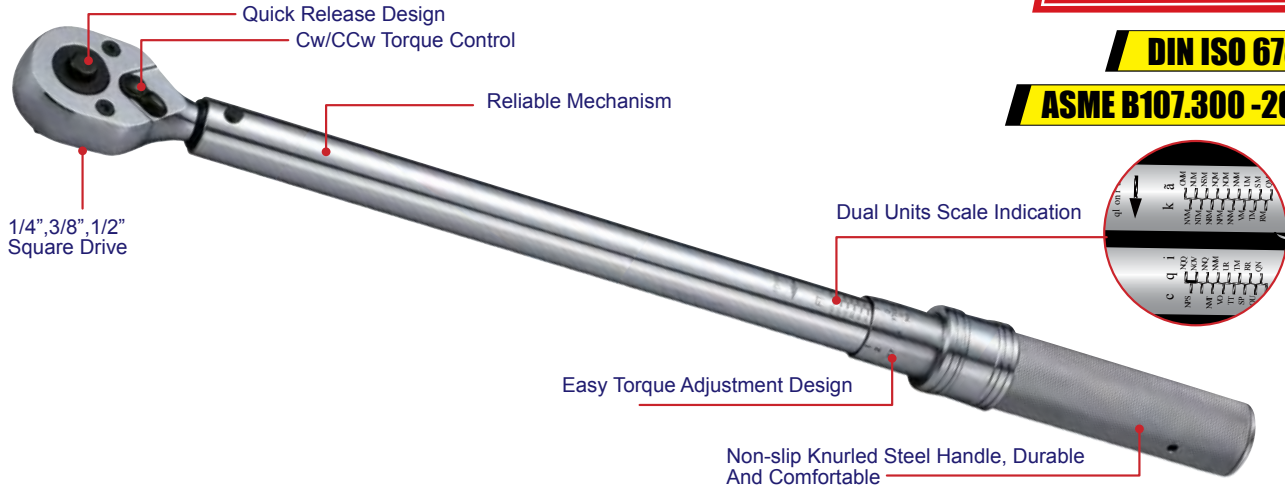

- **Accuracy of torque $\pm 3.0\%$**

Each torque wrench laser serial no. and calibration certificate for future tracing.

- **Dual units scale indication**

Dual units N-m and lbf.in or lbf.ft scale indication.

- **CW/CCW torque control**

Both clockwise and counter clockwise bi-directional torque control. Signals by impulse when torque setting is reached.

- **Easy Torque adjustment**

Easy torque-adjusting design brings energy-saving benefit. Positive locking mechanism avoids accidental setting alterations.

- **Quick release design**

Comes with quick release design, allows changing socket quickly.

- **Reliable Mechanism**

Quality meets DIN ISO 6789 & ASME B107.300-2010.

Idea for motorcycles, bicycle, automobile, truck, heavy machinery, ships, cruise, aerospace industry, high-speed rail and more.



Spec.	HW-T41-315	HW-T41-525	HW-T83-20100	HW-T21-40200	HW-T21-60340
Drive	1/4"/6.35mm Square	1/4"/6.35mm Square	3/8"/9.53mm Square	1/2"/12.70mm Square	1/2"/12.70mm Square
Unit	N-m/lbf.ft Dual units	N-m/lbf.ft Dual units	N-m/lbf.ft Dual units	N-m/lbf.ft Dual units	N-m/lbf.ft Dual units
Torque Range	3.0~15 N-m	5.0~25 N-m	20~100 N-m	40~200 N-m	60~340 N-m
	31~128 lbf.in	53~212 lbf.in	16.6~71.9 lbf.ft	33~144 lbf.ft	52~243 lbf.ft
Accuracy	$\pm 3.0\%$	$\pm 3.0\%$	$\pm 3.0\%$	$\pm 3.0\%$	$\pm 3.0\%$
Graduation	0.1 N-m	0.2 N-m	0.5 N-m	1.0 N-m	2.0 N-m
Gear teeth	64 T	64 T	32 T	32 T	32 T
OAL	8.3" (210 mm)	9.8" (248 mm)	17" (433 mm)	21" (530 mm)	24" (610 mm)

HW-T716-3 7/16" Preset Torque Spanner



- Proper connections at "F" connector interface with factory preset torque setting 30 lbf-in(3.4N-m).
- Narrow head design helps work in tight density space.
- Audible click sound alerts user when full pressure has been applied.
- Ergonomic & cushion handle for comfort and protection.

Handle	Material	Torque range	Drive	OAL(mm)
	HEX			
TPR	ANSI4140	30 lbf-in(3.4N-m)	7/16"(11.1mm)	163

SD-T635 Series ADJUSTABLE TORQUE SCREWDRIVER

INDUSTRIAL GRADE

DIN ISO 6789

ASME B107.300 -2010

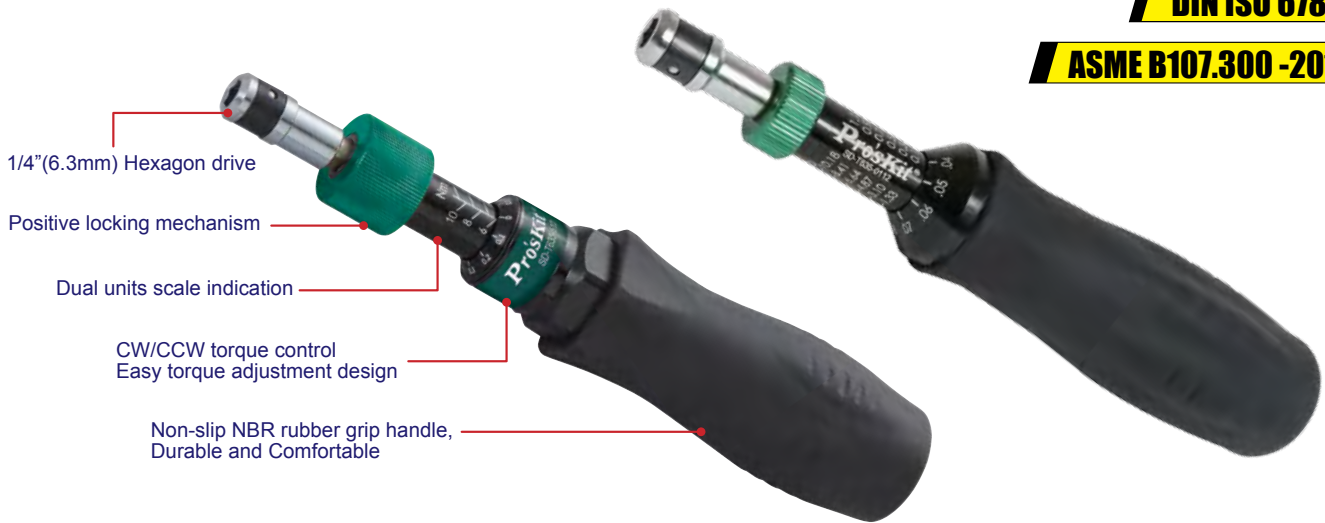

• Accuracy of torque ±6.0 %

Each torque wrench laser serial no. and calibration certificate for future tracing.

• Dual units scale indication

Dual units N.m and lbf.in or lbf.ft scale indication.

• CW/CCW torque control

Both clockwise and counter clockwise bi-directional torque control. Signals by impulse when torque setting is reached.

• Easy Torque adjustment

Easy torque-adjusting design brings energy-saving benefit. Positive locking mechanism avoids accidental setting alterations.

• Reliable Mechanism

Quality meets DIN ISO 6789 & ASME B107.300-2010.

Ideal for electronic, computer, communication, motorcycles, bicycle, automobile, truck, heavy machinery, ships, cruise, aerospace industry, high-speed rail and more.

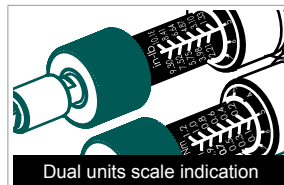

Model No.	SD-T635-0112	SD-T635-16	SD-T635-510
Drive	1/4"/6.35mm Hexagon		
Unit	N-m/lbf.in Dual units		
Torque Range	0.1~1.2 N-m	1.0~6.0 N-m	5.0~10 N-m
	1.33~10.18 lbf.in	13.28~48.68 lbf.in	48.68~84.08 lbf.in
Accuracy	±6.0 %		
Graduation	0.01 N-m	0.1 N-m	
OAL	7" (180 mm)	8" (200 mm)	
Packing	Plastic Box + Shrink Pack		

▶ SD-T636 12 PC Torque Screwdriver Set



Quick release design for speedy Interchanging of bits



Accurate torque adjustable 1 - 6 N-m

• Ergonomic Handle

Dual color torque handle, torque adjustable 1 - 6 N-m, Includes torque adjusting tool for easy torque setting.

• Bits

Includes 10pcs double end bits, common use 20 bit sizes to satisfy most applications. Made by AISI 8660 Cr-Mo-V steel.

• Application

For controlled fastening on electrical engineering installation and maintenance, and more.

• Durable Bag

Arranged properly in a high quality and rugged bag, could be used as convenient storage bag and waist working bag.



Specification
Torque adjustable: 1~6 N-m, Accuracy±6%, recommend calibration after 5000 cycle
Contents:
Dual Color PP/TPR/POM Handle, length:137mm
10PCS AISI 8660 double end hex Bits, length:175mm:
⊖ SL3.0+SL4.0, SL5.5+SL6.35, PH0+PH1, PH2+PZ2, ⊕ PZ0+PZ1,
⊕ T10H+T15H, T20H+T25H, ⊙ H2H+H3H, H4HxH5H
⊕ PZ/FL1+PZ/FL2
Square 8mm torque adjusting tool, length:99mm/40mm

▶ SD-T860 12 PC VDE Torque Screwdriver set



Quick release design for speedy Interchanging of bits



Accurate torque adjustable 1 - 6 N-m

• VDE Handle

Dual color VDE torque handle, torque adjustable 1-6 Nm, Includes torque adjusting tool for torque setting easily. Insulated metal bit holder locks all bits reliably.

• Bits

Individually tested protective insulation 1000 VAC, VDE and GS tested. Includes 10pcs common use bits to satisfy most applications. Made by AISI 8660 Cr-Mo-V steel.

• Application

For controlled fastening on live cable or parts up to 1000VAC, such as power plants, refrigeration and air conditioning systems, electrical engineering installation and maintenance...etc.

• Durable Bag



Torque adjustable 1 - 6 Nm

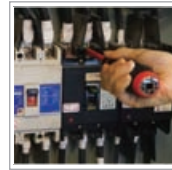

Power plants maintenance



Rugged storage bag

Specification
Torque adjustable: 1~6Nm, Accuracy±6%, recommend calibration after 5000 cycle
Contents:
Dual color PP/TPR/POM handle, length:127mm
10pcs AISI 8660 Bits, length:195mm:
⊖ SL2.5,SL3.0, SL4.0, SL5.5, SL6.5, ⊕ PH0, PH1,PH2, ⊕ PZ0, PZ1
Square 8mm torque adjusting tool, length:99mm/40mm
Individual packing:Color box

HW-6509B/ HW-6514B 9 PC/ 14 PC Combination Wrench

Cr-V Tools meet DIN standard

- Made of Chrome Vanadium Steel with mirror finish provides corrosion resistance
- Compact size for easy access in confined spaces
- Slim line spanners reduce problems with hard to reach nuts
- Complete set for automotive, industry, home use and more
- Comes with tool pouch for easy carrying and storage



Tool Pouch

Model No.	Spec.(Metric)
HW-6509B	8.10.11.12.13.14.15.17.19mm
HW-6514B	8.9.10.11.12.13.14.15.16.17.18.19.22.24mm

Individual packing: Color box

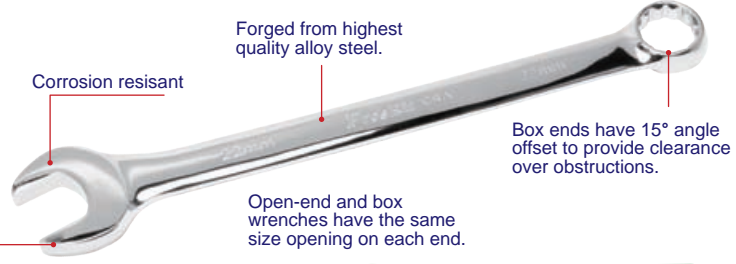

HW-312S / HW-312B 12 in 1 Type Ratcheting Box End Reversible Wrench

RoHS COMPLIANT

- 12 sizes in one reversible ratcheting wrenches for superior versatility and ease of use
- 72-teeth gear design delivers 5 degree effective swing arc which makes work more efficient in limited areas
- Made of heat treated Cr-V steel with full polish for durability
- High torque capacity
- With forward, fixed and reversible function for easy operation



Long bolts and threaded rods are not a problem for the 12 in 1 wrench.

Model No.	Spec.	OAL(mm/inch)
HW-312S	● 8, 10, 11, 13mm	160/6.3
	● 5/16", 3/8", 7/16", 1/2"	
	● E10, E12, E14, E16	
HW-312B	● 14, 16, 17, 19mm	230/9.06
	● 9/16", 5/8", 11/16", 3/4"	
	● E18, E20, E22, E24	

Individual packing: Blister card



72-teeth gear, only 5° space for each turn

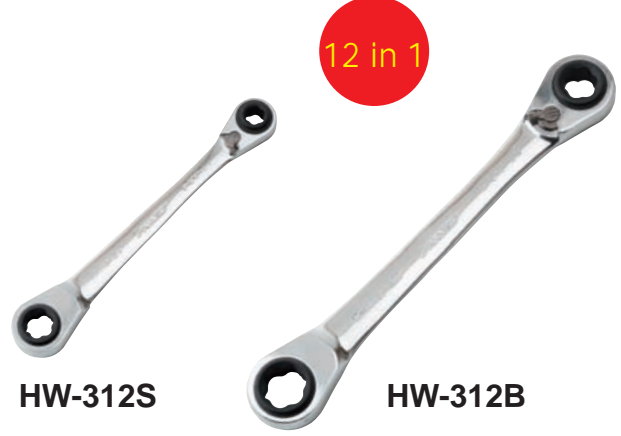

900-070 / 900-217 10 PCS Electronic Combination Wrench

Pb



• Material: AISI 1045

Model No.	Spec.
900-070 (Inch Size)	Closed end 7/16", 11/32", 3/8", 9/32", 5/16", 1/4", 15/64", 7/32", 5/32", 3/16"
	Open end 3/8", 5/16", 11/32", 1/4", 9/32", 15/64", 7/32", 13/64", 3/16", 5/32"
900-217 (Metric Size)	Closed end 11, 10, 9, 8, 7, 6, 6, 5.5, 4.5, 4mm
	Open end 10, 9, 8, 7, 6, 5.5, 5, 4, 4.5mm

Individual packing: Pouch

900-067/900-068/900-069 Adjustable Wrenches

Pb

- Economy type
- Knurled adjustable screw
- Drop forged
- PVC coated handles



Model No.	Material	Jaw open (Max)	OAL.
900-067	S50C	1/2"(13mm)	4"(100mm)
900-068	S50C	13/16"(19mm)	6"(150mm)
900-069	S50C	1"(25mm)	8"(200mm)

Individual packing: Blister card

ESD STATIC PROTECTION

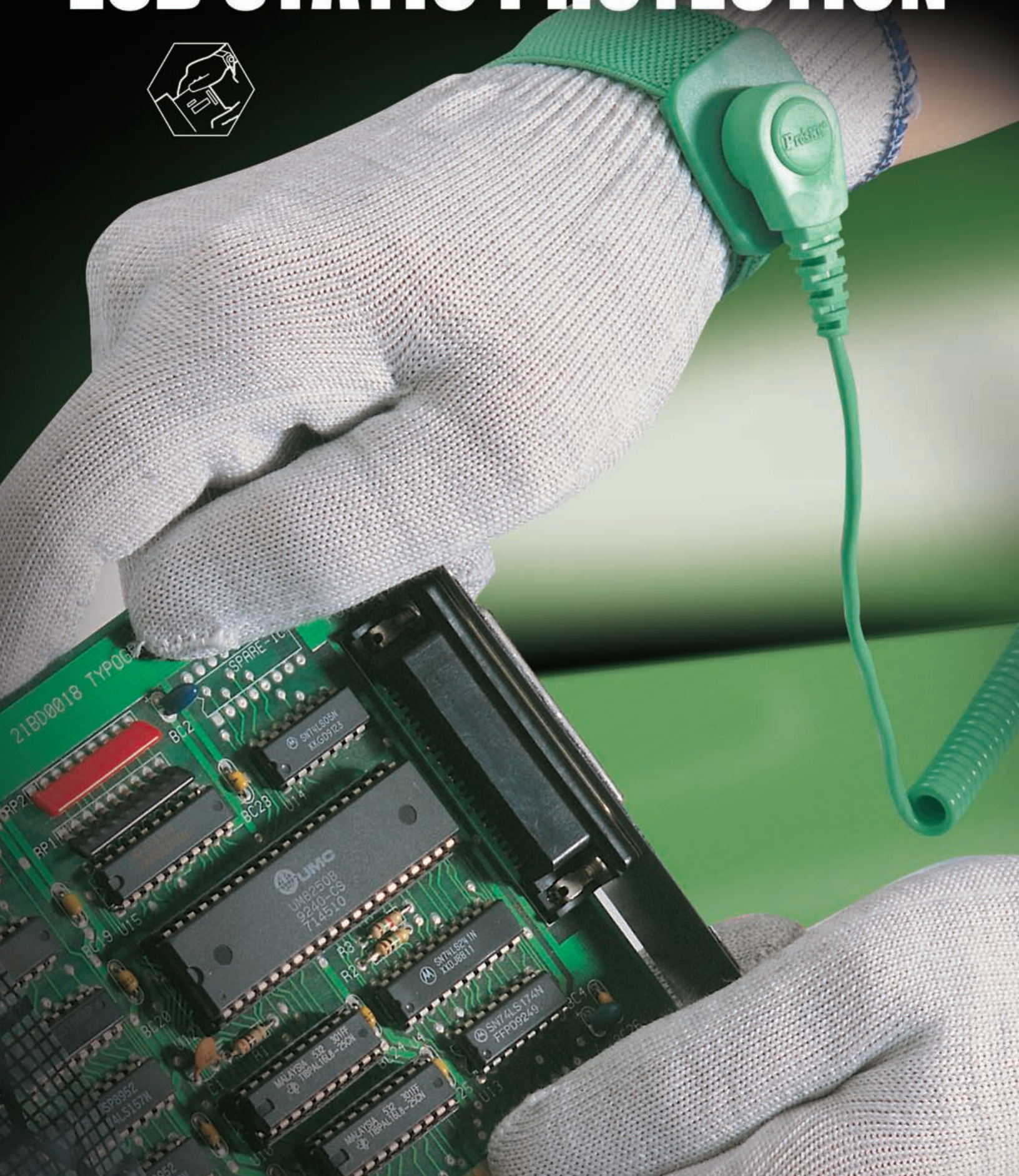

▶ **900-002/900-012 Wrist Strap Series**



Model No.	Band resistivity	Wrist strap resistivity	Band Size	Cord Size (feet)	Individual packing
900-002	<50Ω	10°Ω	Fixed	10 (3M)	Blister card
900-012				6 (1.5M)	

▶ **900-132/900-133 Wrist Strap Series**



Model No.	Band resistivity	Cord resistivity	Band size type	Cord Size (feet)	Individual packing
900-132	<50Ω	10°Ω	Adjustable	10 (3M)	Blister card
900-133				6 (1.5M)	

▶ **900-022/900-023 Wrist Strap Series**



Model No.	Band resistivity	Cord resistivity	Band size type	Cord Size (feet)	Individual packing
900-022	<10°Ω	10°Ω	Adjustable	10 (3M)	Blister card
900-023				6 (1.5M)	

▶ **900-057 Foot & Heel Ground**



These versatile heel grounders have a specially designed dual-layered cup construction for superior floor contact.



Polyester+conductive fiber

Resistivity	Wrist belt	Individual packing
1-2 x 10°Ω	Adjustable	Blister card

▶ **900-056 Field Service Kit**



Material	Conductive PVC
Resistivity	10°-10 ¹¹ Ω
Wrist belt	With 6ft wrist strap and 10ft grounding wire w/alligator clip
Size(mm/inch)	650x600/25.6x23.6
Individual packing	Color box



▶ **900-114/900-116 Static-Dissipative Mat**



Model No.	900-114	900-116
Material	Face layer: 0.2mm laminated PVC Center, Layer: 1.7mm PVC foam, Bottom layer: 0.1mm PVC foam, Combination layer: conductive treatment	
Resistivity	Face & Center & Bottom, Layers: 10M-1KMΩ/SQ Combination layer: 1K-1MΩ/SQ, Static decay time: less than 0.5sec	
Heat tolerance	70°C	
Description	Static dissipative mat for keyboard & mouse & touch	Static dissipative mat for OA desk-top
Size(mm/inch)	600x1200/23.6x47.2	600x600/23.6x23.6
Individual packing	Color box	Color box



TWEEZERS

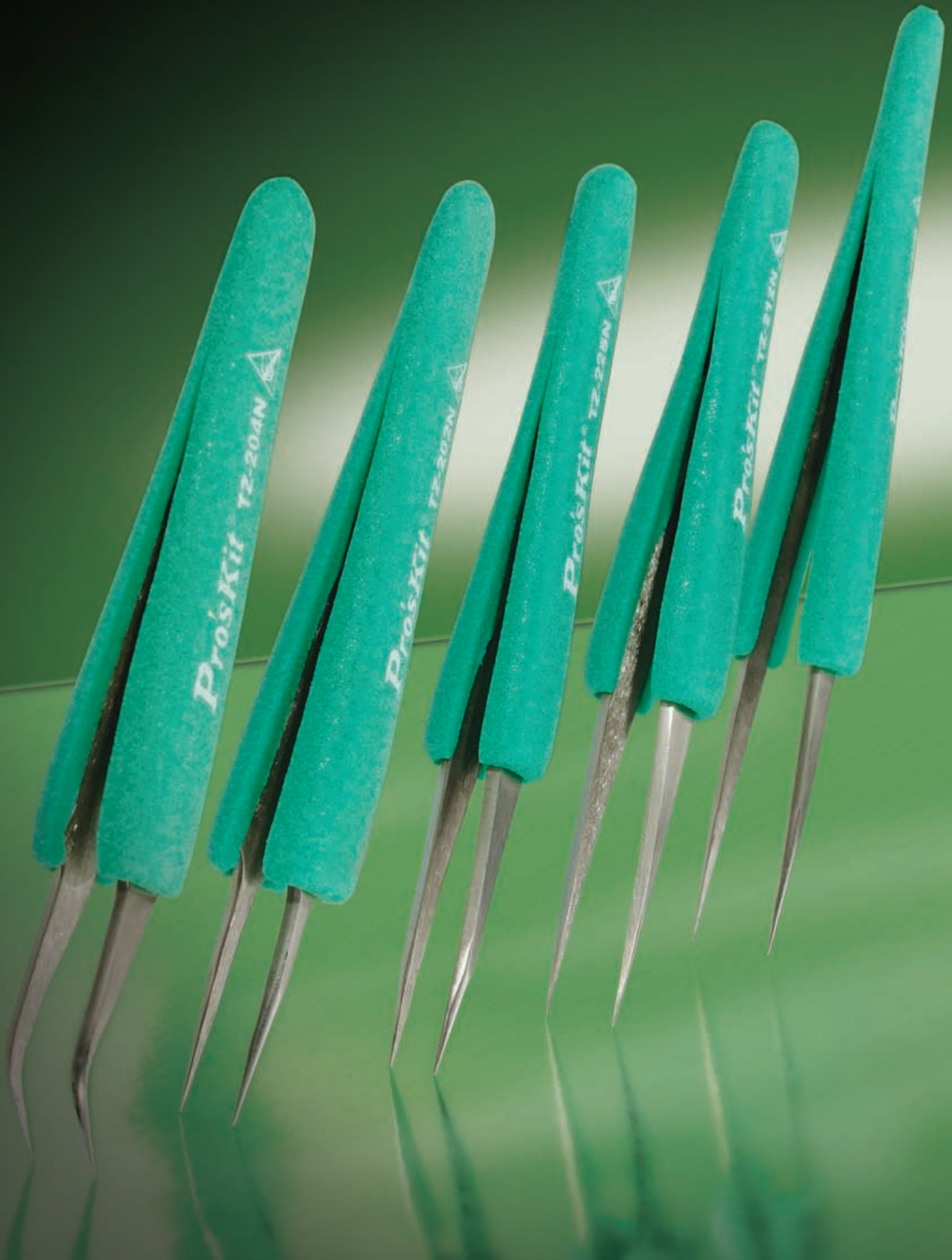



Ergo-Grip Tweezer

- Static dissipative handle 10⁹~10¹¹
- Light weight design
- Precise tip offers safe access to hard-to-reach areas
- Cushioned handle increases operation comfort with less fatigue
- Constructed of high-quality stainless, chemical resistant; tough, non-magnetic surface.

TZ-202N Super Fine Tip Straight Tweezer

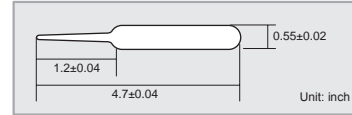

Material	Magnetic	OAL (mm/inch)	Individual packing
AISI 304	Non	120.5/4.7	Blister card

TZ-204N Fine Tip Curved Tweezer

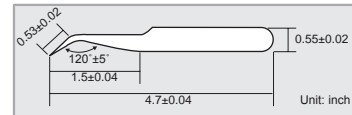

Material	Magnetic	OAL (mm/inch)	Individual packing
AISI 304	Non	120.5/4.7	Blister card

TZ-205N Fine Tip Straight Tweezer

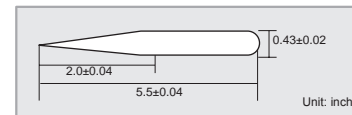

Material	Magnetic	OAL (mm/inch)	Individual packing
AISI 304	Non	140.5/5.5	Blister card

TZ-212N Extremely Fine And Sharp Tip Tweezer

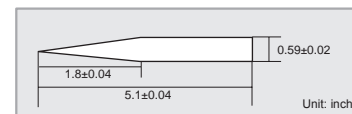

Material	Magnetic	OAL (mm/inch)	Individual packing
AISI 304	Non	129/5.1	Blister card

TZ-225N Super Fine Tip Straight Tweezer

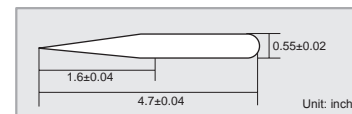

Material	Magnetic	OAL (mm/inch)	Individual packing
AISI 304	Non	120.5/4.7	Blister card

▶ **900-071 Super Fine Tip Straight Tweezer**

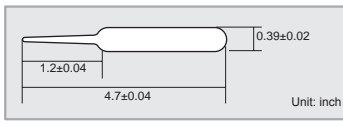

Material	Magnetic	OAL (mm/inch)	Individual packing
AISI 304	Non	120/4.7	Blister card

▶ **900-072 Fine Tip Curved Tweezer**

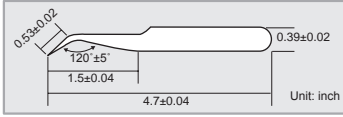

Material	Magnetic	OAL (mm/inch)	Individual packing
AISI 304	Non	120/4.7	Blister card

▶ **1PK-125T Super Fine Tip Straight Tweezer**

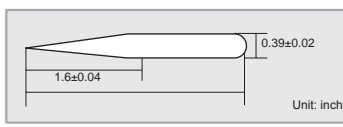

Material	Magnetic	OAL (mm/inch)	Individual packing
AISI 304	Non	120/4.7	Blister card

▶ **902-072 Heavy-Duty Tweezer**

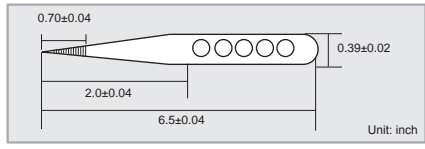
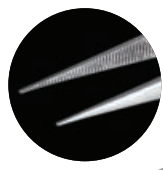

Material	Magnetize-able	OAL (mm/inch)	Individual packing
AISI 410	Yes	165/6.5	Blister card

▶ **900-204 4 PC Tweezer Set**



OAL:115mm/4.5"



OAL:110mm/4.3"

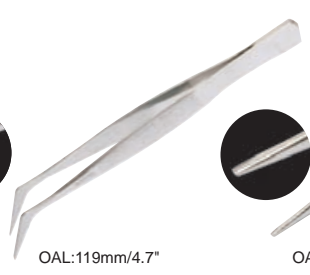

OAL:119mm/4.7"



OAL:116mm/4.6"

Material	Magnetic	OAL (mm/inch)	Individual packing
AISI304	Non	110-120/ 4.3-6.3	Pouch

4 different style stainless steel tweezers for every need. Includes one self-locking; ideal for picking up small components in hard to reach places, as well as component assembly one pc prototype boards.

▶ **902-071 Universal Tweezer**

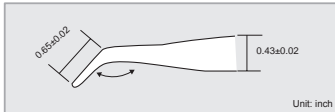

Material	Magnetize-able	OAL(mm/inch)	Individual packing
AISI 410	Yes	175/6.9	Blister card



▶ **900-267 Reverse Action Tweezer (Self-Gripping)**

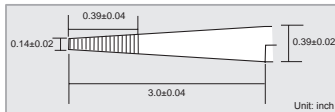

Material	Magnetize-able	OAL (mm/inch)	Individual packing
AISI 410	Yes	165/6.5	Blister card



▶ **900-268 Static Dissipative Soft Tip Tweezer**

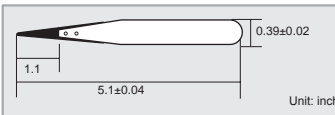

Material		Resistance	Replacement Tip	Magnetic	OAL (mm/inch)	Individual packing
Handle	Tip					
AISI 302	PPS-hb	<10 ⁶ Ω	5TZ-300A	Non	130/5.1	Blister card



▶ **900-269 Static Dissipative Soft Tip Tweezer**

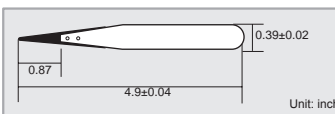

Material		Resistance	Replacement Tip	Magnetic	OAL (mm/inch)	Individual packing
Handle	Tip					
AISI 302	PPS-hb	<10 ⁶ Ω	5TZ-300B	Non	125/4.9	Blister card



▶ **900-263/900-264/900-265/900-266 Conductive Tweezer**



900-263



900-264



900-265



900-266

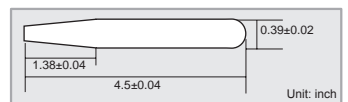
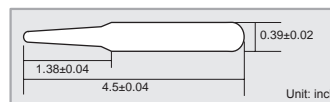
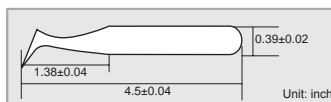
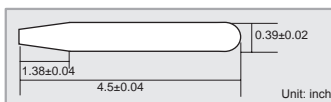

Model No.	Material	Resistance	Magnetic	OAL(mm/inch)	Individual packing
900-263	PC Carbon Fiber	<10 ⁴ Ω	Non	115/4.5	Blister card
900-264				120/4.7	

Model No.	Material	Resistance	Magnetic	OAL(mm/inch)	Individual packing
900-265	PC Carbon Fiber	<10 ⁴ Ω	Non	115/4.5	Blister card
900-266					



MAGNIFIERS & LAMPS



Magnification/Lighting

The materials of **Pro'sKit** magnifier & lamps include **Glass and Acrylic**.

The characteristics of **Glass** :

- **Scratch-resistance:** Glass is not easily scratched due to its high density.
- **High-transmission:** It comes with smooth surface providing high transmission for clear view, anti-dust.
- **Low-glare:** Glass lenses feature low glare to reduce eye fatigue when used for long times.

The characteristics of **Acrylic** :

- **Light-weight:** The weight of Acrylic is only half of glass.
- **Anti-impact:** The impact strength of Acrylic is 7-18 times higher than that of glass.
- **High-transmission:** It has excellent transparency characteristics and transmission is better than glass.



Glass Lens



Acrylic Lens

Magnification Chart of **Pro'sKit** Magnifiers & Lamps :

- **Diopter(D)** means an object has been magnified by 25%.
- **Magnification(X)** a power of 2x means the object size has been magnified by 100%.
- **Focal Length** is the distance from a point where the image of a distance object is formed (focal point) to lens

Diopter	% Bigger Than Object	Magnification (X)	Focal Length (mm/inch)
1D	25%	1.25 X	1016 (40.00")
2D	50%	1.5 X	508 (20.00")
3 D	75 %	1.75 X	339 (13.33")
4 D	100 %	2.00 X	254 (10.00")
5 D	125 %	2.25 X	203 (8.00")
6 D	150 %	2.50 X	169 (6.67")
7D	175%	2.75X	145(5.71")
8 D	200 %	3.00 X	127 (5.00")
9 D	225 %	3.25 X	113 (4.44")
10 D	250 %	3.50 X	102 (4.00")
12 D	300 %	4.00 X	85 (3.33")
20 D	500 %	6.00 X	51 (2.00")
28 D	700 %	8.00 X	36 (1.43")
30 D	750 %	8.50 X	34 (1.33")

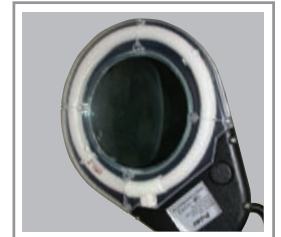
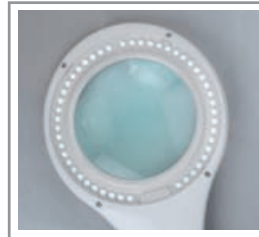
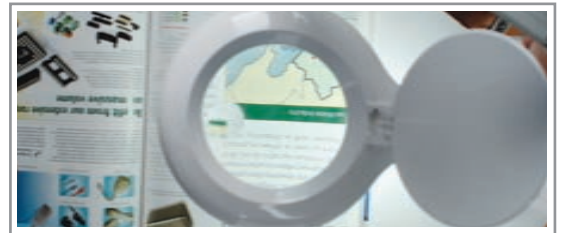

The light source and electronic rectifier:

Pro'sKit is always striving to improve its products to become more energy efficient and environment-friendly. All of **Pro'sKit** magnifiers & lamps come with Electronic Rectifier features reducing the electromagnetic interference to almost zero and meet RoHS compliance. The Electronic Rectifier will provide even more stable performance and will light up more quickly for use than the traditional linear transformer.

Cost effective, Energy saving SMD LED lighting

- Save Energy, Save Money, LED features 80% less energy and 20X longer service lifetime than traditional lamp.
- Provides super brightness as compared to incandescent light.
- LED lighting systems don't radiate heat, environment friendly and cost effective.

Important Facts	Light Emitting Diodes (LEDs)	Incandescent Light Bulbs	Compact Fluorescents (CFLs)
Life Span (average)	50,000 hours	2,000 hours	5,000 hours
Contains the TOXIC Mercury	No	No	Yes <small>It's toxic to your health & the environment</small>
Turns on instantly	Yes	Yes	No <small>takes time to warm up</small>
Durability	Very Durable	Not Very Durable <small>Glass or filament can break easily</small>	Not Very Durable <small>glass can break easily</small>
Heat Emitted	Very low	High temperature	Medium temperature
Electromagnetic	Low <small>(DC current)</small>	High <small>(AC current)</small>	High <small>(AC current)</small>

Light Spectrum Test Report

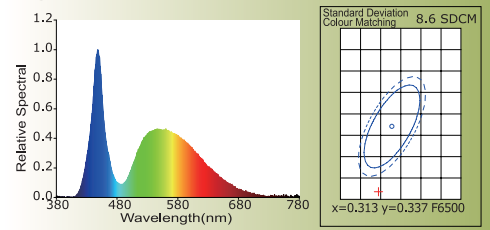

Caring for Eyes

When you are doing any of these things which require staring at one place for 30 minutes, it is important to take a break for 5 minutes and look at things farther away.

MA-1008A LED Magnifier Floor Lamp



- Comes with 42 LEDs that provide bright lighting and only 7W consumption energy saving.
- Up to 50,000 hours, 20X longer lifetime than incandescent lamp.
- Designed with 3D(1.75X) glass lens, provides high transmission for excellent view.
- The folding stand and 180 degree bending and rotating neck on this lamp allows easy adjusting for many applications such as in bed, at a table, behind a sofa, etc.
- Unique gooseneck arm, safer and easier allows angling and pointing the light position easily and safely.
- Floor stand material: Spray painted steel tubing.



Premium magnifier lamp, ideal for professional, home, beauty or hobby use, great reading, nail art, product quality inspection and visual aid.

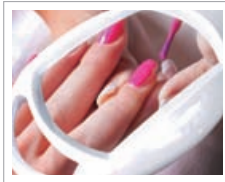

Beauty



Reading



Super bright

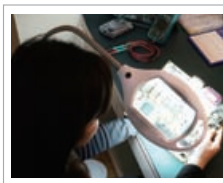

PCB checking



Lamp shade



Hex key

Lens material	Color temperature	Energy consumption	Magnification	
Glass	6000-7000 Kelvin	7 W	3D (1.75X)	
Lens size	Light source	Voltage	Standard plug	Individual packing
100x167mm/3.9"x6.6"	42 pcs LEDs	AC 110-120V	A	Color Box

MA-1209LA LED Table Clamp Magnifier Lamp



- The glass lens will provide high transmittance and will not easily scratch.
- 90 LEDs energy saving, low temperature and long life.
- Standard mount: Desktop clamp
- Power supplied with electronic rectifier provides even more stable performance
- Adjustable arm for easy positioning where it is most needed.
- Clamps easily and securely onto most flat surfaces up to 65mm/2.6" thick.



PCB checking

Lens material	Magnification	Lens size	Illumination	Voltage	Standard plug	Individual packing
Glass	5D (2.25X)	Ø 127mm / Ø5"	90 pcs LEDs	AC 110V-120V	A	Color Box

MA-1219A Ultra-Efficient LED Magnifying Lamp



- Comes with 84 SMD LEDs provides 900 Lumen bright lighting and only 2-18W low consumption.
- There are 3 level illuminations for choice to meet different applications.
- Designed with 3D(1.75X) magnification glass lens, features high transmission for excellent view.
- The unique internal cantilever design allows angling and pointing the light position more easily and safely.

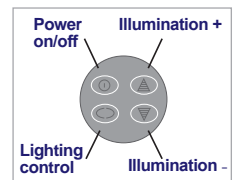

Lens material	Magnification	Lens size	Illumination	Light source	Voltage	Standard plug	Individual packing
Glass	3D (1.75X)	175x130mm 6.9"x5.1"	900 Lumen	84 pcs LEDs	AC 110-120V	A	Color Box

▶ MA-1503A Wide View Magnifier



- Power supplied with electronic rectifier provides even more stable performance
- Even, shadow-free light will make it easier for you to see and reduce eye strain.
- Spring balanced adjustable arm for easy maneuverability and positioning.
- Easy to replace the fluorescent tubes.



Lens material	Magnification	Lens size	Light source	Voltage	Standard plug	Individual packing
Glass	3D(1.75X)	Ø 190 x155mm/ Ø 3.5"x6.1"	PL 9W x 2 pcs	AC 110V-120V	A	Color Box

▶ 902-109 Table Clamp Magnifier With Workbench Lamp



- 5 diopter (2.25X magnification) glass lens.
- Even, shadow-free light under the magnifying lens with 22-watt T5 circular fluorescent tube will make it easier for you to see .
- All metal housing mounted on a spring balanced arm that stays set in any position.
- Clamps easily and securely onto most flat surfaces up to 2.6" thick.
- Dust-proof cover for lens protection.



Lens material	Magnification	Lens size	Illumination	Voltage	Standard plug	Replacment bulb	Individual packing
Glass	5D(2.25X)	ø127mm/ Ø5"	22W/T5 G10q	AC 120V	A	Bulb-T5	Color Box

▶ 900-061/MA-1205CA-B Magnifier Workbench Lamp



- Fully-adjustable spring arm with extra ABS sleeves outside of the springs for secure operation
- Power supplied with electronic rectifier provides reduced electromagnetic interference
- Wide open protection cover design can be swiveled up and won't spring back
- Even, shadow-free light will makes it easier for you to see and enjoy the activities longer.
- Spring balanced adjustable arm for easy maneuverability and positioning.
- Adjustable clamp base fits up to 65mm/2.6" thick surfaces.



Model No.	Lens material	Magnification	Lens size	Illumi-nation	Voltage	Standard plug	Color	Individual packing
900-061	Glass	5D(2.25X)	ø127mm/ Ø5"	22W	AC 120V	A	White	Color Box
MA-1205CA-B					AC 120V	A	Black	

▶ 902-110 Gooseneck Magnifier Lamp



- Power supplied with electronic rectifier provides even more stable performance.
- Even, shadow-free light will make it easier for you to see.
- The flexible gooseneck allows you to angle and point the light to where you need it most.
- Clamps easily and securely onto most flat surfaces up to 65mm/2.6" thick.



Lens material	Magnification	Lens size	Illumination	Voltage	Standard plug	Replacment bulb	Individual packing
Glass	5D(2.25X)	Ø 127mm/ Ø5"	22W/T5 G10q	AC 120V	A	Bulb-T5	Color Box

▶ MA-1004A Desk Type Magnifier Lamp



56 LEDs
3D (1.75X)
Magnification



Energy saving, Zero electromagnetic interference

- Comes with 56 LEDs which provide bright lighting and only 9W consumption.
- The LED features long lifetime reaches to 50000 hours, is 20 times longer lifetime than incandescent lamp.
- Design with 3D(1.75X) magnification glass lens, great for working on hobbies, PCB and documents.
- The adjustable arm allows angling and pointing the light to where you need it to be 3D(1.75X)&2D(4X)40 LEDs Magnification.

Light Spectrum Test Report

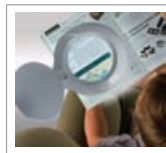
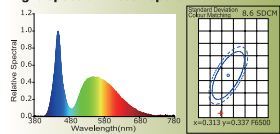

Lens material	Magnification	Lens size	Light source	Color temperature	Luminance	Voltage	Standard plug	Individual packing
Glass	3D(1.75X)	127×79 mm 5"×3.11"	56 pcs LEDs	6000~7000 Kelvin	650 Lumen	AC 110V~120V	A	Color Box

▶ MA-1006A Desk Type LED Magnifier Lamp



30 LEDs
3D (1.75X)
Magnification



- Comes with 30 LEDs which provide bright lighting and only 5.5W consumption.
- The LED features long lifetime reaches to 50000 hours, is 20 times longer lifetime than incandescent lamp.
- Design with 3D(1.75X) magnification glass lens, great for working on hobbies, PCB and documents.
- The adjustable arm allows angling and pointing the light to where you need.

Light Spectrum Test Report

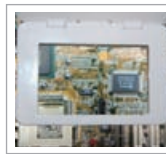
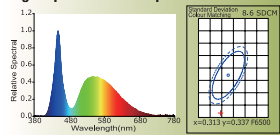

Lens material	Magnification	Lens size	Light source	Color temperature	Luminance	Voltage	Standard plug	Individual packing
Glass	3D(1.75X)	115×73 mm 4.5"×2.8"	30 pcs LEDs	6000~7000 Kelvin	300 Lumen	AC 110V~120V	A	Color Box

▶ MA-1601A LED Working Lamp



84 LEDs



- The adjustable arm allows easy placement in any position you need.
- Comes with switching adapter, provides even more stable performance.
- Design with 84pcs SMD LED, features long service life reaches to 5,000 hours, super bright and energy-saving 80%.
- Both high light and dim light for choices.

Light Spectrum Test Report

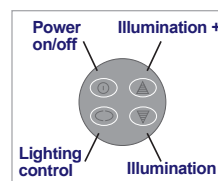
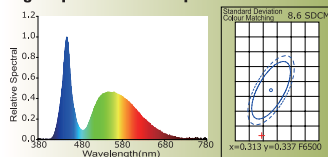

Color temperature	illumination	Overall length	Light source	Voltage	Standard plug	Individual packing
6000~7000 Kelvin	1200 Lumen	92 x 58 x 18 cm 3.6"×2.3"×0.7"	84 pcs LEDs	AC 110V~120V	A	Color Box

▶ MA-1013MA LED Desk Type Magnifier Lamp



- Comes with 40 LEDs which provide bright lighting and only 6W consumption, energy saving.
- Up to 50,000 hours, 20X longer lifetime than incandescent lamp.
- Design with 3D(1.75X) glass lens, and 12D(4X) insert lens to inspect small parts and fine details.
- The adjustable arm allows angling and pointing the light to where you need.
- Flip-down cover to keep the magnifier free of dust.



Lens material	Magnification	Lens size	Light source	Color temperature	Energy consumption	Voltage	Standard plug	Individual packing
Glass	3D (1.75X) & 12D (4X)	Ø100mm /3.9"	40 pcs LEDs	6000-7000 Kelvin	6 W	110-120V AC, 50/60Hz	A	Color Box



40 LEDs
3D(1.75X) & 12D(4X)
Magnification

▶ 902-108 Desk Type Magnifier Lamp



- The adjustable arm allows you to angle and point the light to where you need it most.
- The insert Lens allows partial magnification of object up to 12D for precision work.
- 12W fluorescent circular lamp
- Power supplied with electronic rectifier provides even more stable performance



Lens material	Magnification	Lens size	Illumination	Voltage	Standard plug	Replacement bulb
Glass	3D/12D (1.75X/4X)	Ø 100mm/ Ø3.9"	12W/T4 G10q	AC 110V-120V	A	Bulb-T4

Individual packing: Color box



▶ 902-221 Desk Type Magnifier Lamp



- Easy swivel lens that rotates 360° and tilts 280°
- Powerful 2X(5D) magnifying lens
- 12W fluorescent lamp
- Adjustable joint arm for easy positioning
- Energy efficient and super bright
- Lifiable lens-protection cover

Lens material	Magnification	Lens size	Light source	Illumination	Voltage	Standard plug	Replacement bulb
Glass	2X (5D)	Ø 100mm/ Ø3.9"	T4 12W circular fluorescent lamp Supplied with Electronic ballast	12W/T4	AC 120V 60Hz	A	Bulb-T4

Individual packing: Color box



▶ 902-240 Foldable Magnifier



- Glass lens with adjustable folding arms design.
- Sits on a desk or table and adjusts for varying height and angle.
- Great for working on hobbies, documents, and circuit boards, etc.

Lens material	Magnification	Lens size	Light source	Battery
Acrylic	2D (1.5X)	Ø 130mm/Ø5"	LED	LR1130 (3AG12) x3 (Included)

Individual packing: Color box



▶ OptiVisor Series "OptiVisor" Binocular Magnifier

- Reduces eye strain
- Optical glass (not plastic) lenses
- Genuine leather comfort band



Complete OptiVisor	Magnification@Focal Length	Lense Plate Only
900-079	1.5X @ 20"	900-236
900-082	1.75X @ 14"	900-096
900-081	2X @ 10"	900-147A
900-075	2.5X @ 8"	900-075A
900-063	2.75X @ 6"	900-076
900-235	3.5X @ 4"	900-077

• Individual packing: Color box 900-142 OptiVisor with No Lens

▶ 900-064 "OptiLoupe" 2X Magnifier

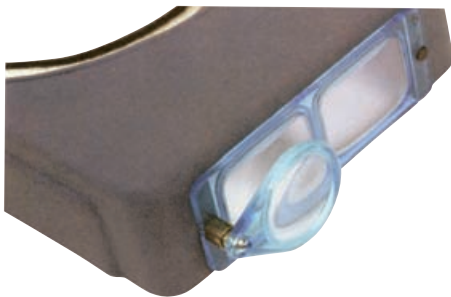

- Bolts onto optivisor to double magnification
- Flips out of the way when not in use
- Individual packing: Blister card

▶ 900-125 Illuminated Magnifier

 Optical quality lighted magnifier with 2-1/2" round lens.

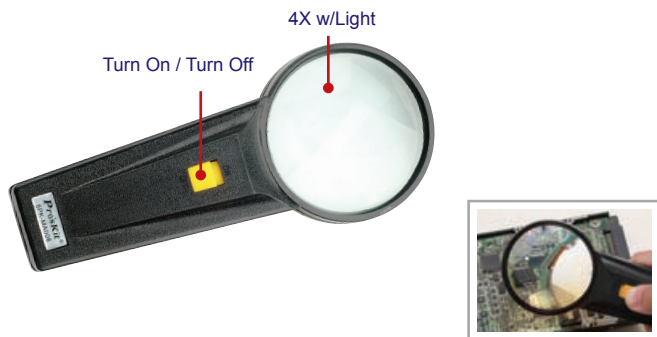

Lens material	Magnification	Lens size (mm/inch)	Light source	Battery	Replacement bulb	OAL	Individual packing
Glass	4X	Ø 62mm/ Ø2.4	Bulb	1.5V AA x 2 pcs (Not included)	900-125B	6-1/2"	Blister card

▶ MA-016 Headband Magnifier



- Detachable LED light device.
- The angle of LED light is adjustable.
- Multiple lens provide better magnification.
- The belt size can be adjusted freely.

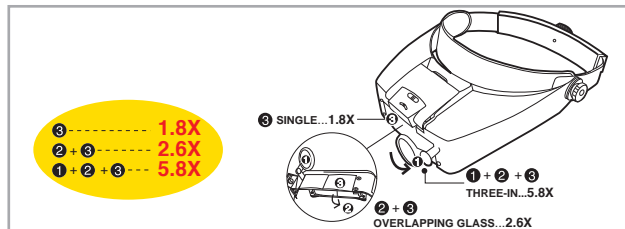

Materials	Acrylic	Light source	LED
Magnification	Single: 1.8X Overlapping: 2.6X Three-in: 5.8X	Battery	1.5V AAAx2 pcs (Not included)
Lens size	Round: Ø 29mm/Ø1.0" Square: 89x29mm/3.5"x1.1"	Individual packing	Color box

▶ 900-080/900-080B VisorLight

- Clips onto headband of Optivisor
- Xenon laser for illuminating close-up work



Model No.	Description	Individual packing
900-080	VisorLight (Headband shown but not included)	Blister card
900-080B	Replacement bulb for Visorlight	Blister card

▶ 900-126 Folding Lighted Magnifier

 Compact magnifier features a 2"x4" rectangular 2X lens, housed in the folding 4" handle.

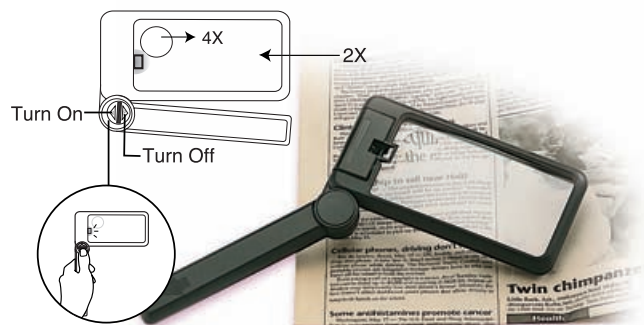

Lens material	Magnification	Lens size (mm/inch)	Light source	Battery	Individual packing
Acrylic	2X / 4X	96x49mm/3.8x1.9	Bulb	1.5V AAA x 2 pcs (Not included)	Blister card

900-123 Sliding Magnifier



3X (one lens)



900-124 Folding Magnifier



Lenses combined for higher magnification



902-239 8X LED Illuminated Magnifier



- Glass lens with hinged stainless cover.
- Great for very small objects, collection, and jewelry.



jewelry



Model No.	Lens material	Magnification	Lens size(mm/inch)	Light source	Battery	Individual packing
900-123	Acrylic	Single:8D (3X) Overlapping: 20D (6X)	22x35mm/ 0.87"x1.4"	-	-	Blister card
900-124		Single: 16D (5X) Overlapping: 36D (10X)	Ø 25mm/ Ø 1.0"	-	-	
902-239	Glass	28D(8X)	Ø 21mm/ Ø0.82"	LED	LRI30 (3AG12) x 3 (Included)	

MA-020 22X Handheld LED Light Magnifier

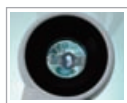

jewelry



- Comes with 2 LED lights
- Excellent for jewelry work

MA-021 3.5X Handheld LED Light Magnifier



PCB checking



- Comes with 2 LED lights
- Suitable for reading, PCB checking and more.

MA-022 7.5X Handheld LED Light Magnifier with Currency Detecting Function



Currency detection



jewelry



- Comes with 1 LED light
- Combine with UV light for currency or credit card detection

Model No.	Lens material	Magnification	Lens size(mm/inch)	Light source	Battery	Individual packing
MA-020	Glass	Object lens 11.5D; Eyepiece 19D, (22X)	Ø 19mm/ Ø0.74"	2 LEDS	1.5V AAA x3pcs (not included)	Blister card
MA-021		10D (3.5X)	Ø 46mm/ Ø1.8"			
MA-022		26D (7.5X)	Ø 27mm/ Ø1.1"	1+1LED (1UV LED)	CR2016 x 2 (not included)	

902-238 3X Magnifier



- Glass lens with plastic holding handle.
- Ideal for very small objects and documents reading.

MA-023 Handheld LED Light Magnifier



3.5X

20X



- Nonslip handle with rubber provides comfortable operation.

MA-019 3X Handheld LED Light Magnifier with Currency Detecting Function



8 LEDS



Reading



Currency detection



- Comes with 8 LEDs light
- With UV light for currency or credit card detection
- Ideal for reading, PCB checking, insect observation.etc

Model No.	Lens material	Magnification	Lens size(mm/inch)	Light source	Battery	Individual packing
902-238	Glass	8D (3X)	Ø 50mm / Ø2"	-	-	Blister card
MA-023	Acrylic	Big Lens: 10D(3.5X), Small Lens: 76D(20X)	Ø 50mm/ Ø2" Ø18mm / 0.7"	2 LEDS	1.5V AAA x3pcs (not included)	
MA-019	Glass	8D (3X)	Ø 56mm/ Ø2.2"	8+1 LEDS (1 UV LED)		

Lighting Solutions

High Quality and Versatile Illumination Solutions for Every Job Type.



▶ 902-469 X-Spot Advance I LED Spotlight

X-SPOT ADVANCE I



- Handheld Power:
- 180 Lumens
 - 27 Hours Battery
 - 400M Range
 - Built in Hands Free Stand
 - Submersible
 - Shock Proof to 1M
 - 3C Batteries (not included)



▶ 902-465 X-Blaze CREE LED Headlamp

X-BLAZE



- Economy & Power:
- 100 Lumens
 - 130m Beam Distance
 - 4 Light Modes
 - Waterproof 1M
 - Corrosion Proof
 - Lock-Out Function
 - 1 AA Battery (not included)



▶ 902-466 Focus+ CREE LED Headlamp

FOCUS+



- Flexibility & Function:
- 100 Lumens
 - Adjustable Beam
 - 6 Light Modes
 - Water Resistant
 - 3 LEDs
 - 6+ Hours Battery
 - 2AA Batteries (not included)



▶ 902-467 Sensor+ CREE LED Headlamp

SENSOR+ ADV I



- Innovative Hands Free:
- 100 Lumens
 - 130M Beam Distance
 - 4 Light Modes
 - Waterproof 1M
 - Corrosion Proof
 - Lock-Out Function
 - 3 AAA Batteries (not included)

CONTROL WITH WAVE OF THE HAND



▶ 902-468 LiteRay LED Headlamp

LITERAY



- Long Shift Visibility:
- Up to 110 Hours Battery
 - 9 through 40 Lumens
 - Water Resistant
 - Shock Proof to 1M
 - 2 AAA Batteries (not included)



▶ FL-516 9 LED Flashlight



LED light

Super bright, Mini size, 1m drop protection

- Sturdy anodized aluminum construction, sealed at both ends with high grade rubber o-rings, water repellent and 1M drop protection
- Super bright LEDs, palm size with wrist strap, ease of use anywhere
- LEDs last up to 100,000 hours
- Ideal for home maintenance, outdoor activities, hiking, night fishing, camping and more



Light source	Material	Size	Battery
9pcs White LEDs	Aluminum	Ø27mm x 92mm	1.5V AAA x 3pcs (not included)

▶ FL-603 LED Flexible Flashlight



LED light

- Sturdy anodized aluminum construction, 13.6" hands free flexible arm attachment
- Flexible cable extension that can be bent and twisted into any shape or angle
- Two-way tail cap switch allows for twist on/off capability or push and hold functionality
- Ideal for auto repair, workshop or home DIY use and more



White light illuminates the tightest work areas

Auto repair

Auto repair

Light source	Illumination	Cable size	Handle size	Battery
White LED	11000mcd	Ø5mm x 13.6"	Ø15mm x 6.9"	1.5V AAA x 3pcs (not included)

• Individual packing: Blister card

▶ 902-068 LED Flashlight



LED light

- Rugged design aluminum body contoured for firm grip.
- Light weight and easy to carry.
- Operated using 2x AA cell batteries (not included).
- Switch on/off control on the bottom.
- Black color.

Battery	OAL (mm/inch)	Individual packing
2 x AA (not included)	152/6	Blister card

Material: Aluminum



▶ 900-239 Magnifier Sheet

- Hold over any subject matter to magnify 3X(8D)~4X(13D)



• Individual packing: Poly bag

▶ MS-710 Anti-Fog UV Protective Glasses



- Anti-UV 400 for sun protection to keep eyes safe.
- Anti-fog coated lens ensure clear vision.
- Durable lenses provide high impact and scratch-resistance.
- 4-position temple length adjustment and hanging hole in the temple ends make it suit most people.



• Individual packing: Blister Card

POWER TOOLS



902-493 20V Cordless Hammer Drill

- 1/2 Inch Keyless Metal Chuck
- Heavy-Duty High Torque
- Two Speed Gear Box (0-400 rpm / 0-1700 rpm / 0-19200 bpm Impact)
- Variable Speed Trigger with Forward/Reverse Switch
- Built-in High Output LED Light Illuminates Work Surface for Increased Visibility
- Includes 6 Drill Bits, 6 Screwdriver Bits and 1 Bit Extender
- Includes 20V Lithium-Ion Battery with LED Battery Level Indicators
- Intelligent Charger Prevents Damage to Battery



Input Power	20V
No Load Speed	0-400 rpm / 0-1700 rpm
Impact Rate	0-19200 bpm
Torque Settings	19+1
Soft Torque	221 in-lbs
Hard Torque	310 in-lbs
Battery Power	1.3 Ah Lithium-Ion
Charge Time	1 Hour
Drill Weight	3.7 lbs (with case 7.6 lbs.)

902-494 20V Cordless Impact Driver

- Universal 1/4 Inch Hex Drive
- Quick Release Chuck
- Heavy Duty High Torque Gear Box, 1350 in/lbs of Driving Force
- Three Built-in LED Lights Illuminate Work Surface for Increased Visibility
- Variable Speed Trigger With Forward/Reverse Switch
- Includes 4 Nut Driver Sockets
- Includes 20V Lithium-Ion Battery with LED Battery Level Indicators
- Intelligent Charger Prevents Damage to Battery



Input Power	20V
No Load Speed	0-2200 rpm
Impact Rate	0-3200 bpm
Hard Torque	110 ft-lbs
Hex Drive	1/4 Inch
Battery Power	1.3 Ah Lithium-Ion
Charge Time	1 Hour
Drill Weight	3.3 lbs (with case 7.2 lbs.)

**▶ 902-495
20V Spare Battery 1.5Ah Li-Ion, or Cordless Drill**

Compatible with 902-492, 902-493, and 902-494.



**▶ 902-496
Charger for 20V Cordless Drill**

Replacement charger for 20V cordless drills. Compatible with 902-492, 902-493, and 902-494.



▶ PT-1136A Cordless Lighted Screwdriver 3.6V



- High quality motor. Speed gear (operating ratio 1:80). 200rpm. Smooth and quiet operation
- Equipped with 3.6V, 1000mAh, rechargeable NI-MH anti-pollution battery. Charging time: 5~7 hrs.
- Maximum output torque up to 25kgf.cm. Ideal for computer, electronic and home repair.
- Adjustable 3 different angle to meet different application's demand.
- Switch for forward or reverse rotation. Easy to screw / unscrew.
- Ergonomic design. Soft grip is easy to handle.
- LED light provides convenient work in the dark area.



Model No.	PT-1136A
Torque setting	None
Rated no load speed	200 rpm
Output torque	2.5 Nm(25.5 kgf-cm/ 22.13 lbf-in)
Drive (collet)	6.35mm (1/4") Hex Bit Shank
Special function	Switch forward or reverse rotation, LED light Handle can be used in 3 different position
Overall length: straight	270mm (10-13/16")
Overall length: angled	210x140mm (7-23/32")
Battery type	Ni-Cd
Battery voltage	3.6V
Battery capacity	800mAh
Charging time	5-7 hours
Free running time	30-35 min. (unload speed)
Input voltage	120V AC 60Hz
Output voltage	DC 6V 300mA
Adaptor plug	A []
Standard accessories	2 pcs magnetic insert bits holder 11 pcs 25mm driver bits: 3.0, 4.0, 5.0, 6.0, 7.0 #1, #2, #3 T10, T15, T20 Adapter
Individual packing	Double blister card

▶ 600-006 Battery Operated Cable Cutter



- DESCRIPTION: Includes charger and rechargeable 12V battery; impact resistant case; forward and reverse cycles; 2" maximum diameter – 750 MCM
- APPLICATION: For use with copper and aluminum cable only - not to be used with steel or ACSR
- REPLACEMENT: 200-032: Blade (moving); 200-033 Blade (stationary); 600-010: Spare Battery
- PACKAGING: Plastic Case



600-010

▶ PT-5501A Variable Speed Rotary Tool Kit



Variable speed, 40pcs accessories, Outer Carbon brush, Flexible shaft

- Powerful variable speed from 10,000 to 32,000RPM
- Flexible shaft and cable attachment allows precision work
- 40-piece multipurpose accessories and carrying case included
- Outer carbon brush for replacement convenience
- Cutting, sanding, polishing, drilling, burr removal and more



Maximum Output	135 W
No Load Speed	10,000-32,000 rpm
Collet Chuck Capacity	3.2mm and 2.5mm
Available Voltages	120V, 60Hz
Plug	A (□)
Carrying Case Size	285x235x80mm / 11.22"x9.25"x3.14"
Individual packing	Color sleeve shrink

▶ PT-5201A Mini Grinder



- Low vibration, high torque and lightweight ergonomically designed.
- Natural and comfortable operation body shape.
- The quick-change chuck is ideal for drilling, polishing, engraving, routing, shaping, sanding and milling.



Replacement accessories: 9PT-5201-P2

Max. diameter	Ø3.2mm
Rated no load speed	5000~14000 rpm adjustable
Adaptor	9PT-5201A-P Output: DC 18V 400mA Input: AC 120V 60Hz Adaptor plug: A (□)
Replacement accessories	9PT-5201-P2 • 2 pcs diamond bits • 2 pcs grinding stones • 2 pcs sanding bands • 1 pc collet (Ø 2.4/ Ø 3.2 mm) • 1 pc nylon brush • 1 pc engraving bit • 1 pc connective post for sanding band
Individual packing	Double blister card

▶ PT-5202A Mini Grinder Set



- The Compact lightweight design and ergonomic soft grip helps you keep a steady hand while you work.
- Build-in LED light provides illumination during use.
- Keyless chuck lock button for easy change accessories.
- Includes 19 accessories and 2 stencils for most tasks.
- Durable plastic storage case for easy organized.
- Ideal for drilling, milling, grinding, polishing, engraving, cutting, and removing.



Cutting

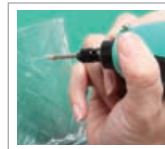

Drilling



Milling, Grinding, Polishing, Removing



Engraving



• Carry case:
142x137x57mm(5.6"x5.4"x2.3")

Collet Size	Max Ø 3.2mm
No-Load Speed	15,000 rpm
Working Voltage	18V DC
Acoustic Pressure	< 70dB
Overall Length	Ø 43x127 mm /Ø1.7"x5"
Input Voltage	100~240VA C 50/60Hz 0.5A Max.
Output Voltage	18V DC 400mA

▶ PT-5203A Electric Engraver



Speed 7100 spm, 9 position stroke setting, LED light

- 9 position stroke setting regulates engraving depth from fine lines to deep grooves.
- Soft TPR handle provides extra comfort and control.
- Comes with LED light allows operating even in dark area.
- Replaceable solid carbide point gives you the power to engrave on different surfaces.
- Light and compact design provides comfortable use for precision engraving performance.
- Ideal for engraving or decorating metal, glass, stone and more.



Accessories:
2 solid carbide tips Ø3.0×20 mm and 1 hex wrench included

Voltage	AC 120V 60Hz
Consumption	10W
Speed	7,100 spm
Stroke setting	9 Position
Engraver point holder	Ø3.0mm
Standard plug	A (□)

Hole Making

▶ 902-481 QuikPunch Kit

- Description: 6pc manual knock out set.
- Application: Punch mild steel up to 10 gauge, aluminum, fiberglass and plastic.
- Packaging: Blow-molded Case.
- 1/2" to 2" conduit sizes. Punched holes are actually larger.



QuikPunch

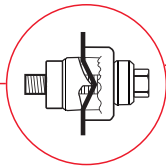

Punch design creases slug as the punch is drawn into die.

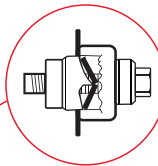

Slug is split in half as punching operation is completed.



Split slugs fall free from die and stud.

Replacement	
902-485	Replacement Punch Die Set - 1/2" Type C
902-486	Replacement Punch Die Set - 3/4" Type C
902-487	Replacement Punch Die Set - 1" Type C
902-488	Replacement Punch Die Set - 1-1/4" Type C
902-489	Replacement Punch Die Set - 1-1/2" Type C
902-490	Replacement Punch Die Set - 2" Type C
902-481-SBS	Replacement Shaft and Bearing - Small
902-481-SBM	Replacement Shaft and Bearing - Medium

▶ 500-036 Hole Saw Kit



- 11pcs hole saw
- Long lasting bi-metal material
- Very sharp, cut through material fast
- Cut through wood, plaster, mild steel
- 3 different sized arbors
- Triangular shank 1/4" fits hole saws 7/8", 1-1/8"
- Triangular shank 7/16" fits hole saws 1-3/8" 1-1/2", 1-3/4", 2", 2 1/2", 3", 3-5/8", 4-1/8", 4-1/2"
- SDS plus shank fits hole saws 7/8", 1-1/8"
- Extension Bar: 12" length fits hex shank 7/16" arbor
- Hex Key: 4mm

Contents	
11pcs hole saw : 7/8", 1-1/8", 1-3/8" 1-1/2", 1-3/4", 2", 2-1/2", 3", 3-5/8", 4-1/8", 4-1/2"	
12" extension arbor	
1/4" arbor, 7/16" arbor	
SDS plus arbor	
Sturdy blow-molded case	
Individual packing	Color Label

▶ 902-482 Tuff Punch



TuffPunch

- Description: Hydraulic Knockout Punch with Type C punch/die sets
- Application: Lightweight design for fast, easy one-person operation. Develops 6.75 Tons of hydraulic force for easy punching.
- Packaging: Blow-molded Case

Included in kit:	
Round knockout punches type c	1/2", 3/4", 1", 1-1/4", 1-1/2", 2"
7/16"X3/4" draw stud	1 Pc
3/4"X3/4" draw stud	1 Pc
Spacer	1 Pc
Blow-molded case	1 Pc

▶ Steel Auger Installer Bits

- Ultra-sharp threads for better pulling power.
- Wire fishing holes in the head and shank.
- Three flat non-slip grip on the chuck end of the flexible spring steel shank.
- Application: Wood

Model No.	Description	Length (Inch)	Drill DIA. (Inch)	Shank DIA. (Inch)	Weight (Oz)
902-500	3/8 in. x 36 in. Auger Installer Bit	36	3/8"	3/16"	4.6
902-501	3/8 in. x 54 in. Auger Installer Bit	54	3/8"	3/16"	6.9
902-502	3/8 in. x 72 in. Auger Installer Bit	72	3/8"	3/16"	9.1
902-503	9/16 in. x 36 in. Auger Installer Bit	36	9/16"	3/16"	7.0
902-504	9/16 in. x 54 in. Auger Installer Bit	54	9/16"	3/16"	8.8
902-505	9/16 in. x 72 in. Auger Installer Bit	72	9/16"	3/16"	11.0

Made in USA



▶ 902-508/902-509 Sheet Metal Installation Tools

- Sheet metal installation tools for drilling and driving 1/4-inch or 5/16-inch head sheet metal screws.
- One piece drill and drive tool with a 1/4-inch quick change shank.
- Retractable 1/8-inch heavy duty high speed drill bit.
- No loose sockets.

902-510 Tool Accessories Kit

Tool Accessories Kit Includes:

- 3/32-in. Allen wrench and three 10-32 set screws
- Includes three 1/8-in. heavy duty high speed drill bits
- Handy storage case



Model No.	Description	Length (Inch)	Width (Inch)	Depth (Inch)	Weight (Oz)
902-508	1/4-in. Sheet Metal Installation Tool	6	1	1	2.8
902-509	5/16-in. Sheet Metal Installation	6	1	1	2.8
902-510	Sheet Metal Tool Accessories Kit	6	1	1	0.8



902-508
1/4"
Sheet Metal
Installation T



902-509
5/16"
Sheet Metal
Installation

▶ 902-506/902-507 Flexible Extender

- Three flat non-slip grip on the chuck end
- Flexible spring steel shank
- Wire fishing accommodation holes in the shank
- For use with 3/16" Diameter flex drills

Model No.	Description	Length (Inch)	Width (Inch)	Depth (Inch)	Weight (Oz)
902-506	3/16-in. X 36 in. Installer Bit Extension	36	0.5	0.5	6.3
902-507	3/16-in. X 54 in. Installer Bit Extension	54	0.5	0.5	8.2



▶ 902-483 Tuff Punch Swivel

- Description: Hydraulic Knockout Punch with Swivel Head and Type C punch/die sets
- Application: Lightweight design for fast, easy one-person operation. Develops 7 Ton of hydraulic force for easy punching. Allows unlimited driver orientation to simplify access to work area.
- Packaging: Plastic Box



Included in kit:	
Round knockout punches type c	1/2", 3/4", 1", 1-1/4", 1-1/2", 2"
7/16"X3/4" draw stud	1 Pc
3/4"X3/4" draw stud	1 Pc
Spacer	1 Pc
Blow-molded case	1 Pc

TuffPunch Swivel



FIBER OPTICS



Fiber Optic Tools Technical Basics

Pro'sKit® is a leading supplier of fiber optic tools and accessories. The **Pro'sKit®** one-stop shop provides complete solution for fiber optic termination tools such as strippers, Kevlar cutters, viewing scope, testers, fiber scribes, and cleaning kit.

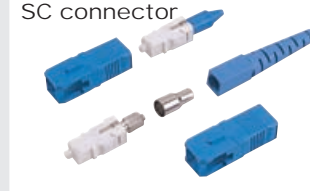
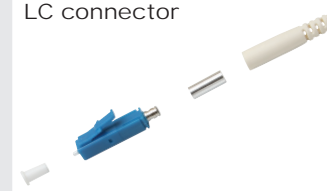
Fiber Optic Connectors types (For reference only, we don't offer fiber connectors)

<p>ST connector</p>  <p>For datacom and telecom, widely used</p>	<p>SC connector</p>  <p>For multimode, rarely single mode, APC not possible</p>	<p>LC connector</p>  <p>For high-density connections, SFP transceivers</p>	<p>MTRJ connector</p>  <p>For duplex multimode connections</p>
---	--	--	---

Fiber Optic Termination Procedure

STEP 1	Stripping PVC jacket 	STEP 5	Bonding 	STEP 9	Inspection 
STEP 2	Cutting Kevlar 	STEP 6	Crimping Connector 	STEP 10	Continuity testing 
STEP 3	Stripping Buffer & Coating 	STEP 7	Cleaving Fiber 	STEP 11	Power Loss testing 
STEP 4	Cleaning 	STEP 8	Polishing Fiber 		

Fiber Optic Cable Test Method:

After the cables are installed and terminated, it's time for testing. For every fiber optic cable assembly, you will need to test the continuity, end-to-end loss and troubleshoot the problems. **Pro'sKit®** fiber optic tester will help to do this step more efficiently.

Continuity test by MT-7501 / MT-7505

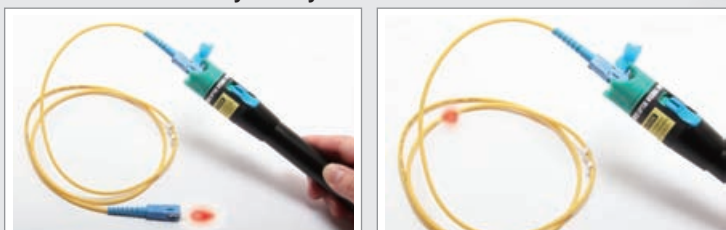

Continuity test

Locate break point

End-to-end loss test by MT-7601 / MT-7602

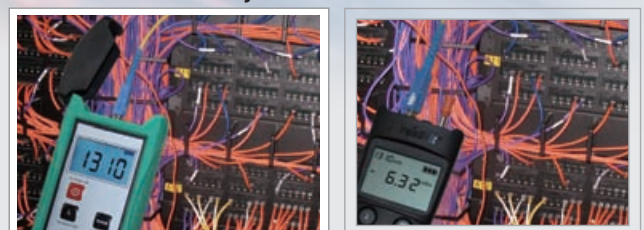

Fiber Tester

Fiber optical power test

▶ MT-7601 Fiber Optic Power Meter



- Adapts to FC/SC/ST connectors
- Automatically auto power off after 10min of no operation
- 850nm/ 1300nm/ 1310nm/ 1490nm/ 1550nm/ 1625nm
- Comfortable LCD backlight display
- Can store the current laser source as a new reference value



Additional shock-proof cover & pouch bag



Fiber optic power test



Compatible connectors (LC with optional adaptor)

Detector Type	InGaAs
Optical Connector	FC/SC/ST& 2.5mm Universal
Calibrated Wavelengths	850, 1300, 1310, 1490, 1550,1625
Measurement Range	+6 ~ -70 dBm
Accuracy	(1550nm, 1310nm)±0.2dB/ (1490nm, 1625nm)±0.3dB/ (850nm, 1300nm)±0.4dB
Power Measurement Linearity	±2.0%
Display Resolution	+6 ~ -60dBm:0.01 dB (-60 ~ -70dBm:0.1 dB)
Power Display Units	dBm, mW, μW, nW
Reference comparison value	Yes
Modulation Detection	270Hz, 1KHz, 2KHz (850, 1300, 1310, 1490, 1550, 1625)
Operation voice prompts	Yes
Backlight	Yes
Automatic Power Off	10 min.(Can be cancelled)
Low Battery Warning	Low battery energy
Body protection	Yes
Battery Life	> 160 hours
Operating Temperature	-10 ~ +60 °C, < 90%
Storage Temperature	-20 ~ +70°C, < 90%
Power source	AA/LR6 1.5V×2 pcs (not included)
Size	165×80×35 mm / 6.5"×3.1"×1.4"
Weight	180g (w/o battery)
Optional Accessory	LC adaptor (5MT-7601-LC)
Individual packing	Color box

▶ MT-7602 4 In 1 Fiber Optic Power Multimeter



4 in 1 1. FIBER POWER METER 2. VISUAL FAULT LOCATOR 3. LAN CABLE TESTER 4. LED FLASHLIGHT

- Simple 3 push-button operation
- Built-in USB connector for battery charger
- Auto power off for energy saving



RJ-11/RJ-45 Cable Tester (Remote)



Fiber optic power test



Cable tester



Break in fiber test



LED flashlight

Optical Power Meter	Detector Type	InGaAs
	Optical Connector	ST/SC/FC & 2.5mm Universal
	Calibrated Wavelengths	850/1300/1310/1490/1550/1625 nm
	Measurement Range	+6 ~ -70 dBm
	Accuracy	±0.2dB
Visual Fault Locator	Power Measurement Linearity	± 0.1 dB
	Display Resolution	± 0.01 dB
	Power Display Units	dBm, μW, mW
	Output Power	<1mW
	Range	3-5 km @SM
Lan Cable Tester	Connector	ST/SC/FC & 2.5mm Universal
	Laser Safety Rating	Class 2
	Wavelength	650nm±20nm
	Output Modes	Continuous (CW) , 2 Hz pulsed
	Reverse Battery Protection	Yes
Automatic Power Off	Connector	RJ45 & RJ11
	Cable	UTP LAN cable(8P8C), Telecom cable(6P2C/6P4C/6P6C)
	Measuring Length Max.	600 meter
	Automatic Power Off	10 min.(Can be cancelled)
	Low Battery Warning	Low battery energy
Battery Life	Power Source	AA/LR6 1.5V rechargeable battery ×2 (not included)
	Size	105×52×34 mm / 4.1"×2"×1.3"
	Optional Accessory	LC adaptor (5MT-7601-LC)
	Individual packing	Color box

▶ 902-186N/MT-7509 Fiber Optic Visual Fault Locator



Measuring distance : 8KM



902-186N



ST FC SC



MT-7509



LC

Model No.	Connector type	Light source	Nominal wavelength	Battery	OAL(mm/inch)	Individual packing
902-186N	2.5mm/0.1" (FC/SC/ST)	Class 3A laser diode	650±10nm	1.5V AAA x2pcs (Not included)	Ø13.5x155mm/ Ø0.53"x6.1"	Color box with black EVA inner case
MT-7509	1.25mm/0.05" (LC)	Class 3A laser diode	650±10nm			

▶ MT-7501 / MT-7505 Fiber Optic Visual Fault Locator

1 Sec. Quick Illuminate

To make checking work convenient

2 Operation Modes

Locating fault accurately

3 Supported Connectors

To give more versatile choice (FC/SC/ST)

- Portable, durable and easy to use
- Both continuous and flashing modes available
- Additional pouch for convenient storage
- Supports 2.5mm universal connectors (for FC/SC/ST)
- Dust-proof & crash-proof cap design for laser head



Continuity test



Locate break point



Accessory

3-5 Km

1 mW



FDA
MT-7501

6-7 Km

5 mW



FDA
MT-7505



Compatible connectors (LC with optional adaptor)

Model No.	Wavelength	Output power	Light source	Tested fiber length	Power (batteries)	Connector	OAL	Operating temperature	Storage temperature	Optional accessory	Individual packing
MT-7501	650 nm±10 nm	1 mW	CLASS II	3-5KM	AA (1.5 V) x 2	2.5mm universal connector for FC, ST and SC	175mm 6.9"	-10-55°C	-10-70°C	LC adaptor (5MT-7601-LC)	Color box
MT-7505		5 mW	CLASS IIIA	6-7KM							

▶ 900-138 Fiber Optic Viewing Scope Kit



This fiber optic viewing scope kit makes it simple to view ST/SC Pre-encapsulated FDDI, and the ends of fiber before and after cleaving operations.



Made in USA

Magnification	Light source	Battery	OAL (mm/inch)	Individual packing
200X Adjustable	Bulb 2.25V / 0.25A	1.5V AAx2pcs (not included)	148x46x25mm/ 5.8"x1.8"x0.98"	Blister card

▶ FB-1688C Fiber Cleaver with Scrap Collector

Standard Precision Single Mode Fiber Cleaver

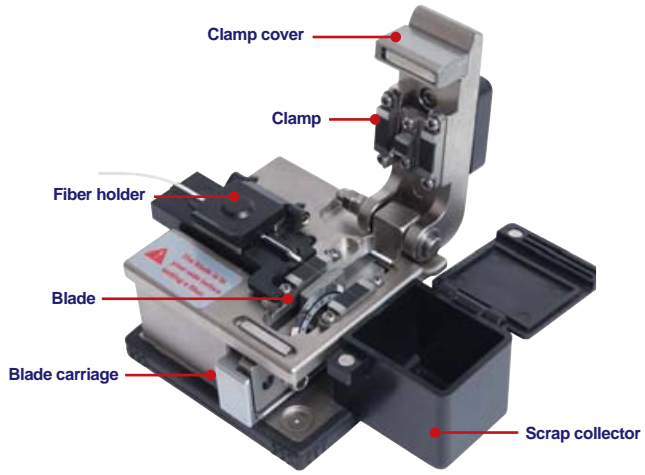

- Simple and easy replacement of blade
- 16 cutting location for each blade, service life up to 48000 times
- Replacement blade is available, model No: 5FB-1688-BLADE



Cladding Diameter	Fiber Count Coating Diameter	Cleave length	Dimensions	Cleaver Blade (5FB-1688-BLADE)	Individual packing
125 μm	Single fiber 250μm & 900μm	5-20 mm	62x60x56 mm 2.4"x2.4"x2.2"	16 cutting points Material: Tungsten steel	Color box

▶ FB-C008 / FB-C009 Fiber Optic One Click Cleaner

600 cleans for FC/PC, ST, SC or LC Connectors and Bulkheads
Cleaning system rotates 180° for a full sweep

Extendable nozzle allows easy to reach the recessed connectors
Indication Window for easy checking

Easy pushing motion engages cleaner with audible click sound
Dry cleaning cloth eliminates the need for solvents



FB-C008

2.5mm FIBER OPTIC ONE CLICK CLEANER



FB-C009

1.25mm FIBER OPTIC ONE CLICK CLEANER



Model NO.	Applications	Length		Cleaning capacity	Individual packing
		Standard	Extended		
FB-C008	2.5 mm FC/PC, ST and SC Connectors and Bulkheads	175 mm / 6.9"	210 mm / 8.3"	600 +	Blister card
FB-C009	1.25 mm LC Connectors and Bulkheads				

▶ FB-C010 Fiber Optic Connector Cleaner

Refillable cleaning tape

Full cleaning for SC, FC, MU, LC, ST, D4, DIN Connectors

- Special non-alcohol high density textile fiber type eliminates the need for solvents
- Offering over 500 cleans for SC, FC, MU, LC, ST, D4, DIN Connectors
- Indication see through window for easy checking



The refillable cleaning tape: Model No.5FB-C010-RPM

Material	Cleaning times	Applications	Dimensions	Individual packing
high density textile fibers	500/per box	For cleaning SC, FC, ST, MU, LC, D4, MT, DIN connector	115x79x32 mm 4.5"x3.1"x1.3"	Blister card

200-047 Fiber Optic Stripper

Pb Strips 125 micron glass fiber with 250 micron buffer coating without scratching or nicking glass fiber.

1.6-3.0mm	600-900um
600-900um	250um
250um	125um

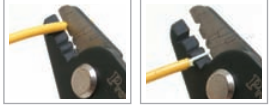

Material	HRC	OAL(mm/inch)	Individual packing
S50C	48±2'	148 / 5.8"	Blister card

100-035 Fiber Optic Kevlar Cutter

Pb

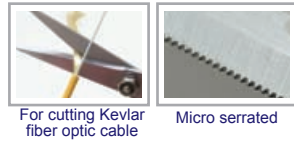

Handle	Blade HRC	Hardness (Cutting edge)	OAL	Individual packing
TPR	60~62'	HV1200	160mm / 6.3"	Blister card

900-176 Syringe Pack



Individual packing
Poly bag+Header card (3pcs/pack)

900-157 Carbide Fiber Scribe



OAL(mm/inch)	Individual packing
Ø12x130mm Ø0.47"x5.12"	Blister card



900-219 Foam Swabs Cleaning Kit

Pb **RoHS** COMPLIANT
For clean up of organic & inorganic residue in clean room and other areas. Ideal for fiber optic clean work



Individual packing
Blister card

900-137/902-260 SC/ST/LC Polishing Disk

Pb **RoHS** COMPLIANT
• Insert connector into polishing disk.
• Polish using a figure 8 motion on sandpaper sheet (not included)

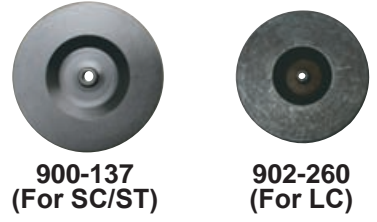

Model No.	OAL (mm/inch)	Individual packing
900-137	32.8/1.3"	Blister card
902-260	37.8/1.5"	

Fiber Lapping Film

• The fiber lapping film consists of precision graded diamond particles resin bonded to a uniform mylar film

Model No.	Specifications	Color
FB-6008-0.5D	Diamond Lapping Film, 0.5µM, Ø5" disk	White
FB-6008-1D	Diamond Lapping Film, 1µM, Ø5" disk	Gray
FB-6008-3D	Diamond Lapping Film, 3µM, Ø5" disk	Pink
FB-6008-6D	Diamond Lapping Film, 6µM, Ø5" disk	Brown
FB-6008-9D	Diamond Lapping Film, 9µM, Ø5" disk	Blue
FB-6008-30D	Diamond Lapping Film, 30µM, Ø5" disk	Green
FB-6008-15SIC	Silicon Carbide Lapping Film, 15µM, Ø5" PSA polis disc	Olive green
FB-6008-30SIC	Silicon Carbide Lapping Film, 30µM, Ø5" PSA polis disc	Olive green
Individual packing	Poly bag	

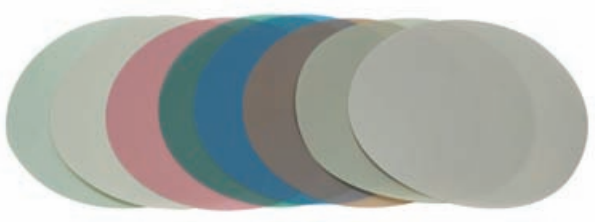

PK-6940 / PK-6942 Fiber Optic Tool Kit



The tool kit contains a complete set of fiber optic termination tools such as strippers, crimpers, kevlar cutters, viewing scope and testers, also available are fiber scribes, and cleaning kit for easy and quick termination.

PK-6940	PK-6942
Fiber optic visual fault locator (For LC connector)	(None)
Fiber optic visual fault locator (For FC/SC/ST connector)	
Foam swabs cleaning kit	
Fiber optic viewing scope kit (SC/PC/FC)	
Fiber optic viewing scope disk (LC)	
Fiber optical stripper	
Carbide fiber scribe	
LC/SC/ST Fiber polishing disk	
Universal syringe 2.5ml	
8.7" fiber optic crimping tool	
Fiber optic kevlar cutter	
Utility component storage box	
Deluxe compact tool case (250x210x90mm/9.8"x8.3"x3.5")	
Individual packing	Color Box

500-023 Fiber Optic Tool Kit



Contents	
Crimper - with additional die for more connector types (.100"/.213"/.218"/.190" and .042/.068/.151/.178/.213)	
Nick-free strippers	
Ergonomic wire cutters	
Kevlar cutting scissors	
TrueView fiber scope kit	
SC/ST/FC polishing disks	
Double-sided component box	
Swabs	
Alcohol bottle	
Syringe	
Tweezers	
Chisel tip scribe	
Zipped bag (280x197x70mm/11"x7.8"x2.7")	
Individual packing	Inner box + Color label shrink

PK-9458 FTTH Fiber Optic Tool Kit



Professional FTTH tool kit contains the most essential tools for fiber optic fusion splice, Mechanical Splicing and patch cord termination procedure. Ideal for fiber optic installation and maintenance works.

21 pcs professional tool

Includes 4 in 1 fiber optic power multimeter, 1.25mm/2.5mm cleaning tool, fiber stripper, drop cable stripper, kevlar scissors, optical Fiber Cleaver, 6P/8P crimpers, LED head light.

Contents	
MT-7602	4 in 1 fiber optic power multimeter
FB-C008/FB-C009	1.25/2.5mm One click Cleaner
FB-1688	Fiber cleaver
CP-376TR	4P/6P/8P Telecom Crimping Tool
CP-FB01	Ftth drop cable stripper
8PK-326	Fiber optical stripper
1PK-067DS	Dual color side cutting plier (165mm/6.5")
9SD-207B	Pro-soft screwdriver (+#26x100mm/1"x3.9")
9SD-201A	Pro-soft screwdriver (-3.0 3.0x75mm/0.1"x3")
DK-2043	Fiber optic kevlar cutter
DK-2060	Auto stop measuring tape
MS-018	Leak proof dispenser pump bottle
FL-528	1W LED head light
PD-2612	8 Oz curved claw hammer
SB-1592	Component storage box(145x92x40mm)
MS-153A	Bulb blower (φ42mm)
8PK-C002	Foam swabs cleaning kit
5MT-7601-LC	Fiber optical power meter lc adaptor
9PK-153	Brush
9TC-752	Aluminium frame tool case (400x280x134mm/15.7"x10.9"x5.3")
Individual packing	Color box

MISCELLANEOUS



MS-526 12 IN 1 MULTI-TOOL

★ **STAINLESS**



- Rugged stainless steel construction, corrosion-resistant.
- With nonslip rubber grip handle, more durable and comfortable.
- Comes with spring loaded long nose cutting pliers head.
- Folds to a compact pocket size that is convenient to take anywhere.
- With pouch bag for easy storage.
- Dimension: 6.1"(155mm) Overall (not including knives) and 3.9"(100mm) closed.

Application
Pliers, Scissor, Saw, Phillips screwdriver, Bottle opener, Cna opener, Knife, Flat file, Falt screwdriver, Awl/Knife, Flat screwdriver

MS-525 9 IN 1 MULTI-TOOL



- Made of stainless steel, rugged and corrosion-resistant.
- Anodized aluminum handles with nonslip grip, more durable and comfortable.
- Comes with spring loaded long nose cutting pliers head.
- Folds to a compact pocket size that is convenient to take anywhere.
- With pouch bag for easy storage.
- Dimension: 6.3"(160mm) Overall (not including knives) and 3.9"(100mm) closed.

Contents
Serrated knife, Can opener, Phillips screwdriver, Knife, Saw, Bottle opener, Flat screwdriver, Flat file

902-461 Triple Thread Chaser Set

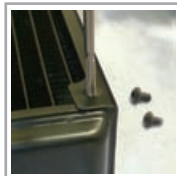

Ideal for iron, aluminum, zinc alloy, plastic.

- Comes with high speed steel blade and PVC handle.
- Quickly forms new threads, re-forms burred threads, and cleans out plaster obstruction.
- Taps three hole sizes and each tap size rethreads to next larger size if threads are stripped
- Applicable to iron, aluminum, zinc alloy, copper, fiber PCB, bakelite, plastic.

Contents	902-461(2 pcs/set)	
Tap Sizes	6-32, 8-32, 10-32	10-24, 12-24, 1/4-20
Torque	≥ 23kg-cm	≥ 70kg-cm
Hardness	HRC 64 [±] 2°	
Material of handle	PVC	
Material of blade	High speed steel (H.S.S.)	
Handle size	Φ20×80mm	
Blade size	Φ4.8×45mm	Φ6.3×45mm
OAL	125mm / 4.9"	

900-150/900-151 Measuring Tape

- Blade with Nylon coating for easy scale reading and avoiding light reflection.
- Magnetic end-hook for convenient measuring.
- Anti-slip and shockproof rubber case.
- Hi-rel power tape.

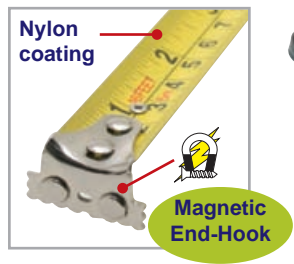

Model No.	L (Max.)	W (Max.)	Individual packing
900-150	5M/16ft	19mm/3/4"	Blister card
900-151	7.5M/25ft	25mm/1"	Blister card

PD-160 16" Digital LCD Angle Level

- Easily readable LCD Display shows the exact angle at once.
- Automatically shuts off after 5 minutes.
- Comes with backlight allowing use even in dark area.
- Data hold function helps user record the reading .
- Mechanical locking function.

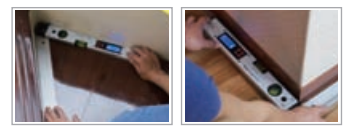

Material	Measuring angle range	Digital accuracy	Measuring precision	Auto shut off
Aluminum Alloy steel	0 to 225 degrees	0.1 degree	±0.5 degree	5 min
Backlight	Dual spirit(bubble) level indicators	Size of the LCD display	Battery Type	Length (mm/inch)
Yes	Vertical / Horizontal	50x19mm 2"x0.7"	DC 9V (6F22) (not included)	400/15.6
				Individual packing
				Color box

PD-155 9" Torpedo Level

- Lightweight and compact
- With magnet for hands-free work
- Provides accurate readings, including horizontal, vertical and 45-degree angles.
- Easy-to-read with fluorescent green gauges



Material	3 vials	OAL	Individual packing
ABS plastic construction	45°, 90° & 180°	220mm/9"	Blister card

400-044 6" Digital Caliper

- Hardened stainless steel.
- High quality 6"(150mm), thumb wheel for accuracy and ease with 4 measurement: inside, outside, depth and step.
- Precision-ground and lapped measuring surface.



Material	Range	Accuracy	Resolution	Individual packing
AISI430	0-150mm/0-6"	±0.02mm/0.001"(<100mm) ±0.03mm/0.001"(>100mm)	0.1mm / 0.0005"	Plastic box + Color label sleeve

902-532/902-533 Electrical tape

- 7-mil (0.18m) thick polyvinyl chloride (PVC) color-coding tape
- Temperature range of 0-176°F (-18°C-80°C)
- UL Listed
- 3/4 in x 66 ft



Individual packing
10 rolls/pack
(Priced by the individual roll)

▶ **CE-0275 Pin Extractors**



- Designed for use with various connectors such as MOLEX, AMP, TYCO, etc
- 5 different size insertion tools
- Available individually or as a set of 5 in a pouch



Put the pin extractor into housing



Push the plunger of pin extractor



Extract the pin

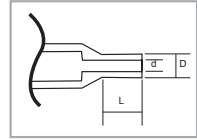

Model No.	L	DØ	dØ	(D-d)/2	Remark
902-394	0.45"	0.150"	0.122"	0.014"	-
902-395	0.57"	0.106"	0.085"	0.011"	Inter-locking
902-396	0.50"	0.157"	0.110"	0.023"	-
902-397	0.79"	0.126"	0.102"	0.012"	V.35 male
902-398	0.67"	0.130"	0.110"	0.008"	V.35 female
CE-0275 Contents: One each of five extractors above. Comes in plastic carrying pouch.					
Individual packing				Blister card	

▶ **900-032 PLCC Extractor**

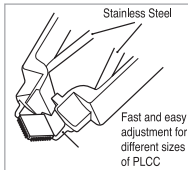

A spring assisted chip carrier extraction tool, specially designed for the safe removal of PLCC's from sockets without damage to component parts.

Material	OAL (mm/inch)	Individual packing
AISI 304 + POM	100x50/ 3.9"x2	Blister card

▶ **902-224 PLCC Extractor**

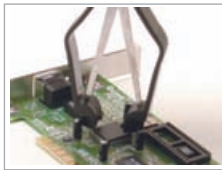

Material	OAL (mm/inch)	Individual packing
AISI 210 + POM	145x76/ 5.7x3	Blister card

▶ **900-258 IC Extractor**

- Stainless steel construction for removing dual in-line IC packages. (Insulated vinyl grip.)

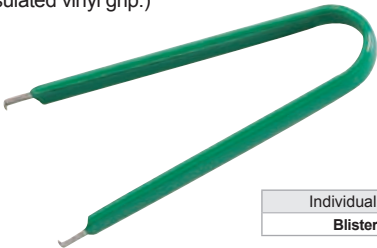

Individual packing
Blister card

▶ **900-094 3-Pronged Parts Grabber**

- Plunger opens prongs



Individual packing
Blister card



▶ **900-065 Insertion/Extraction Tool**



- RS232 insertion & extraction use
- Red: insertion PIN
- White: extraction PIN

Model No.	Body	Handle	O.A.L (mm/inch)	Individual packing
900-065	Metal	PP	102/4	Pouch

▶ **902-070/902-073 Spring Hook**

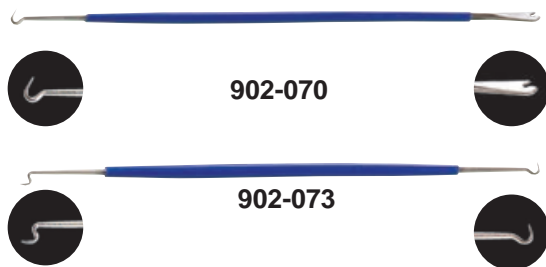

• Can grab small spring and wires.



Model No.	Material	OAL (mm/inch)	Individual packing
902-070	AISI 410	205/8	Blister card
902-073	+ PVC		

▶ **900-205 4 PCS Probe Set**



• 4pcs stainless steel single-ended probe that can be used for all kinds of precision work in electronics.
• Hook, curved, straight and angle tips 4 types packed in a vinyl pouch.



Material	OAL (mm/inch)	Individual packing
AISI 410	Straight:145/5.7 Angled:140/5.5	Pouch

▶ **1PK-3179 5 PC Spudger/Prying Tool Assortment**

This set contains 5 tools for opening and prying tablet computers, cell phones, monitors and disconnecting small electronic components without damaging housing or parts.



Contents
1 PC Double-ended metal spudger OAL:185mm
1 PC Nylon solder aid tools, OAL:150mm
2 PCS Polyoxymethylene (POM) opening levers, OAL:84.4mm, 88.7mm
1 PC Prying paddle, 30.5x30.5x30.5mm

▶ **MS-161 Heavy-Duty Suction Cup**

MS-161 comes with ABS handle and TPR suction cap, features comfortable grip and high suction capacity up to 11kgs. Easy to remove the glass-sheathed displays.



• Size: Ø 58mm x 72mm
• Max. Load: 11kgs (24.3lbs)

Material	suction cup	Suction Capability	Dimension(mm/inch)	Individual packing
ABS	TPR	11kgs (24.3lbs)	Ø 58mm x 72mm/ Ø 2.3" x 2.8"	Blister card

▶ **900-019 5 PCS Needle File Set**

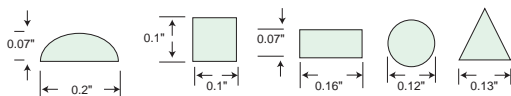

Material	HRC	Cut length	Handle O.D.	OAL	Individual packing
SKS-8	60°	75mm/ 3.0"	Ø 5mm/ Ø 0.2"	170mm/ 6.7"	Pouch

▶ **900-216 5 PCS Needle File Set**

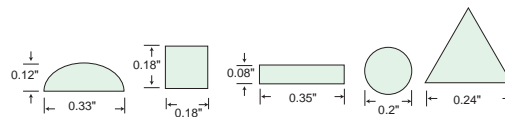

Material	HRC	Cut length	Handle O.D.	OAL	Individual packing
SKS-8	60°	85mm/ 3.3"	Ø 7mm/ Ø 0.28"	180mm/ 7.1"	Pouch

900-103 Inspection Mirror

- All-angle ball joint mirror with stainless steel back.
- Visual inspection of hidden areas.
- Double ball joint links swivel mirrors for viewing to 360°.
- Made of tempered spring steel to move freely and hold desired position.
- Replaceable, plated, copper-backed, clear-view mirror.
- Non-rotating inner hex rods prevent mirror from swinging out of alignment.
- Insulating vinyl grip.



Lens size	OAL	Individual packing
50x90mm 2"x3.5"	216 ~ 490mm 8.5"~19.3"	Blister card



900-255 Inspection Mirror

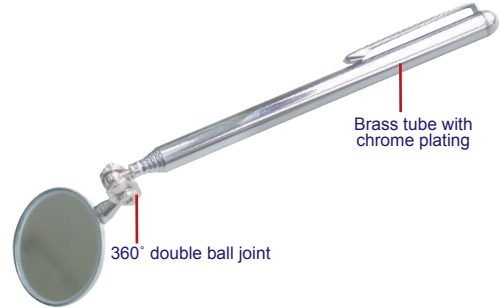

Lens size	Extension length	Individual packing
Ø32mm (1.25")	178~505mm (7.9"~19.9")	Blister card



MS-322 Telescopic Magnetic Pick-Up Tool

- A handy chrome plated telescopic magnetic retrieving tool.
- Ideal for hard-to-reach working.
- Extension length: max. 450mm(17.7")
- Maximum pick-up: 590g(1.3lb)



Individual packing
Blister card

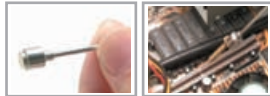

900-158 Automatic Center Punch



Tip Material	OAL (mm/inch)	Individual packing
HSS	133/5.2	Blister card



900-177 Multi-Fuse Puller

- Shock-proof durable plastic
- Serrated grip design to prevent slipping
- Safely removes 0~200A/250V and 0~100A/600V Cartridge fuses



Individual packing
Blister card

800-070 Magnetizer Demagnetizer



- A convenient pocket sized tool, housed in a strong plastic case.
- Ideal for the general magnetizer demagnetizer of small hand tool i.e screwdriver, hexagon keys.



Individual packing
Blister card

902-256/902-257 Push-button Pick-up Tool



902-257 (600mm/23.6'')



902-256 (265mm/10.4'')



Open the jaws

Pick up the object easily

- 900-256: Push-Button Pick-Up Tool has a 265mm /10.4" flexible stem with a small set of jaws at one end.
- 900-257: Long Push-Button Pick-Up Tool has a 600mm /23.6" flexible stem with a small set of jaws at one end.
- Ideal for home, shop, garage, work place etc.

Individual packing	Blister card
--------------------	--------------

902-255 Long Pick-up Tool with Magnet Tip



902-255 (620mm/24.4'')

Powerful magnet lifts

1.5KG



Pick up small metallic objects from inaccessible areas

- Long Pick-Up Tool with Magnet Tip is an extendable magnetic tool for picking up small metallic objects from inaccessible areas.
- This Pick-Up Tool has a 620mm/24.4" flexible stem with a strong magnet at one end.
- Powerful magnet lifts 1.5KG
- Ideal for home, shop, garage, work place etc.

Individual packing	Blister card
--------------------	--------------

902-511 Storage Strap

- Industrial strength & weather resistant
- Holds up to 150 lbs.
- Width and length 3x23 inch.



Demo only
(Hose not included)

Material	Individual packing
Nylon	Hanger

MS-C002 Mini Vacuum & Blowing Cleaner



High speed 25000 rpm and easy-to-use handy vacuum cleaner with attachments for vacuuming / blowing / brushing off dirt and dust.



Vacuum cleaner



Sweeping brush



Blowing cleaner



Speed	Torque	Output	Power	Size(mm/inch)	Individual packing
25,000 rpm	26 g-cm	5.15W/1.83A	DC 6.0V (AA 1.5V×4 pcs)	Ø 45×130×90 / Ø 18.0×5.1×3.5	color box

▶ **902-117 Multi-Angle Swivel-Actions Vacu-Vise**

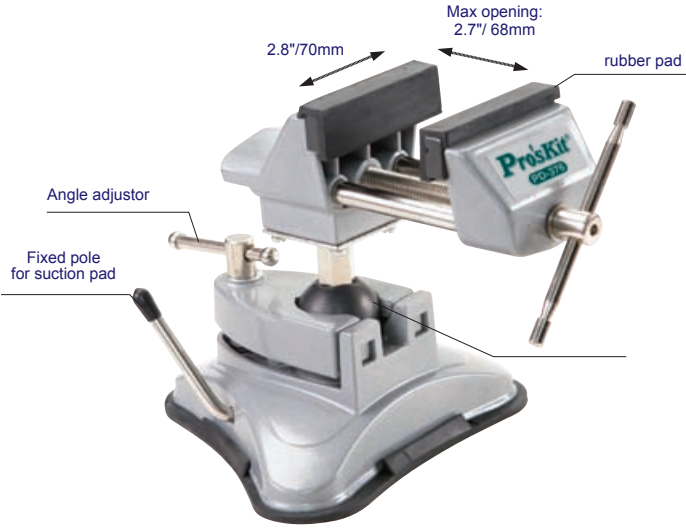

- Suction areas must be smooth, flat and clean.
- Adding a little water under vacuum base is recommended.

- Swivels 360° and tilts 90° to desired angle.
- 2.8" (70mm) metal jaws open to 2.7" (68mm).
- Equipped with slide-on rubber jaw for fragile work.
- 6 1/4" (158mm) triangular base.
- Aluminum die-cast construction.
- Light weight and durable.

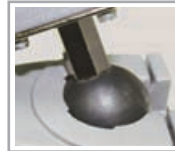

360° rotary maximum incline level: 45°

Replacement Jaw	Individual packing
902-117-JAWS	Plain box+Color label

▶ **PD-372 Mini Vise**



Max opening : 0.98"/25mm

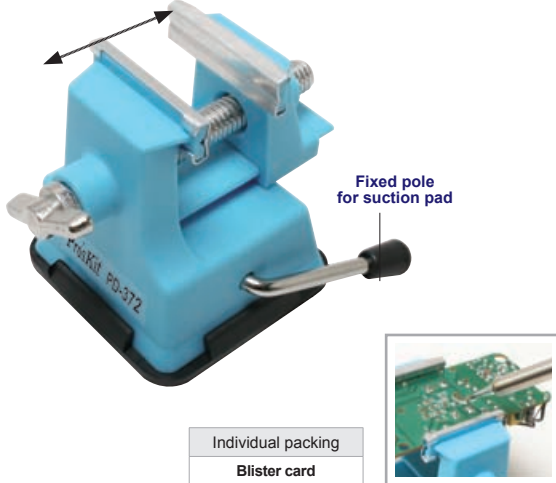

Individual packing
Blister card



▶ **900-049 Hobby Vise**

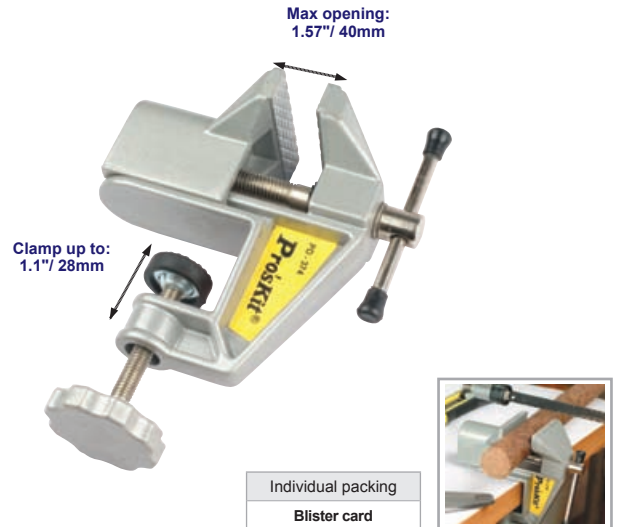

Individual packing
Blister card



▶ **900-179 Heavy Duty Curved-Claw**



Material	Weight	OAL (mm/inch)	Individual packing
Handle: Fiberglass, S45C	454g (16 oz/1 lb)	330/13	Tag

▶ **902-116 6 In 1 Mini Hammer**

- The 6 in 1 mini hammer with six different interchangeable heads: two round steel, one flat brass, one flat plastic and one tinner's steel.

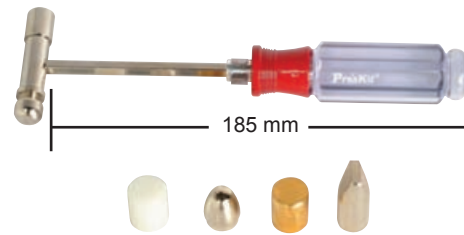

OAL (mm/inch)	Individual packing
185/7.3	Blister card

CONNECTORS



Assorted Splitters



902-369



902-370



902-371

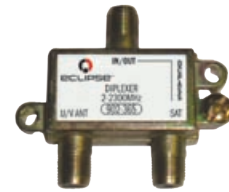

902-365



902-362



902-363



902-364



Splitters		
Description	Part No.	Type
2-2,300 MHz	902-362	2-Way
	902-363	3-Way
	902-364	4-Way
5-1,000 MHz	902-369	2-Way
	902-370	3-Way
	902-371	4-Way

Diplexer		
Description	Part No.	Type
2-2,300 MHz	902-365	2-Way

(Required the use of a separator)

Crimp-On, Twist-On, Push-On Connectors

902-382
902-367

CRIMP-ON



902-368

TWIST-ON



902-384



902-383

PUSH-ON

F Type Coax Crimp-On Connectors			
Description	Part No.	QTY	PKG
Crimp-On RG6Q	902-382-10	10	Blisterpack
	902-382-100	100	Jar
Crimp-On RG6	902-367-10	10	Blisterpack
	902-367-100	100	Jar

F Type Coax Twist-On Connectors			
Description	Part No.	QTY	PKG
Twist-On RG6	902-368-10	10	Blisterpack
	902-368-100	100	Jar
Twist-On RG59	902-384-10	10	Blisterpack
	902-384-100	100	Jar

F Type Coax Push-On Connectors			
Description	Part No.	QTY	PKG
Push-On RG6	902-383-10	10	Blisterpack
	902-383-100	100	Jar



Compression Style Connectors -F, RCA & BNC Type

- Provide high quality termination and years of trouble free service
- Waterproof
- 360° shield termination



705-001-BK 705-002-BU 705-004-WH 705-004-YL 705-004-RD 705-004-GN 705-004-BK 705-004-BU 705-006-BK 705-007-BU
705-003-BK 705-005-BK 705-008-BK

F

RCA

BNC

Model No.	Description	Pkg Q'ty	Individual packing
705-001-BK	F connector for RG6/U (Black)	100 pcs	Jar
705-001-BK-50	F connector for RG6/U (Black)	50 pcs	Jar
705-001-BK-20	F connector for RG6/U (Black)	20 pcs	Blisterpack
705-001-BK-10	F connector for RG6/U (Black)	10 pcs	Blisterpack
705-002-BU	F connector for RG6 Quad (Blue)	100 pcs	Jar
705-002-BU-50	F connector for RG6 Quad (Blue)	50 pcs	Jar
705-002-BU-20	F connector for RG6 Quad (Blue)	20 pcs	Blisterpack
705-002-BU-10	F connector for RG6 Quad (Blue)	10 pcs	Blisterpack
705-003-BK	F connector for RG59/U (Black)	100 pcs	Jar
705-003-BK-50	F connector for RG59/U (Black)	50 pcs	Jar
705-003-BK-20	F connector for RG59/U (Black)	20 pcs	Blisterpack
705-003-BK-10	F connector for RG59/U (Black)	10 pcs	Blisterpack
705-004-GN	RCA connector for RG6/U (Green)	100 pcs	Jar
705-004-GN-50	RCA connector for RG6/U (Green)	50 pcs	Jar
705-004-GN-20	RCA connector for RG6/U (Green)	20 pcs	Blisterpack
705-004-GN-10	RCA connector for RG6/U (Green)	10 pcs	Blisterpack
705-004-BU	RCA connector RG6/U (Blue)	100 pcs	Jar
705-004-BU-50	RCA connector RG6/U (Blue)	50 pcs	Jar
705-004-BU-20	RCA connector RG6/U (Blue)	20 pcs	Blisterpack
705-004-BU-10	RCA connector RG6/U (Blue)	10 pcs	Blisterpack
705-004-BK	RCA connector for RG6/U (Black)	100 pcs	Jar
705-004-BK-50	RCA connector for RG6/U (Black)	50 pcs	Jar
705-004-BK-20	RCA connector for RG6/U (Black)	20 pcs	Blisterpack
705-004-BK-10	RCA connector for RG6/U (Black)	10 pcs	Blisterpack
705-004-RD	RCA connector RG6/U (Red)	100 pcs	Jar
705-004-RD-50	RCA connector RG6/U (Red)	50 pcs	Jar
705-004-RD-20	RCA connector RG6/U (Red)	20 pcs	Blisterpack
705-004-RD-10	RCA connector RG6/U (Red)	10 pcs	Blisterpack
705-004-YL	RCA connector RG6/U (Yellow)	100 pcs	Jar
705-004-YL-50	RCA connector RG6/U (Yellow)	50 pcs	Jar
705-004-YL-20	RCA connector RG6/U (Yellow)	20 pcs	Blisterpack
705-004-YL-10	RCA connector RG6/U (Yellow)	10 pcs	Blisterpack
705-004-WH	RCA connector RG6/U (White)	100 pcs	Jar
705-004-WH-50	RCA connector RG6/U (White)	50 pcs	Jar
705-004-WH-20	RCA connector RG6/U (White)	20 pcs	Blisterpack
705-004-WH-10	RCA connector RG6/U (White)	10 pcs	Blisterpack
705-005-BK	RCA connector RG59/U (Black)	100 pcs	Jar
705-005-BK-50	RCA connector RG59/U (Black)	50 pcs	Jar
705-005-BK-20	RCA connector RG59/U (Black)	20 pcs	Blisterpack
705-005-BK-10	RCA connector RG59/U (Black)	10 pcs	Blisterpack
705-006-BK	BNC connector for RG6/U (Black)	100 pcs	Jar
705-006-BK-50	BNC connector for RG6/U (Black)	50 pcs	Jar
705-006-BK-20	BNC connector for RG6/U (Black)	20 pcs	Blisterpack
705-006-BK-10	BNC connector for RG6/U (Black)	10 pcs	Blisterpack
705-007-BU	BNC connector for RG6 Quad (Blue)	100 pcs	Jar
705-007-BU-50	BNC connector for RG6 Quad (Blue)	50 pcs	Jar
705-007-BU-20	BNC connector for RG6 Quad (Blue)	20 pcs	Blisterpack
705-007-BU-10	BNC connector for RG6 Quad (Blue)	10 pcs	Blisterpack
705-008-BK	BNC connector for RG59/U (Black)	100 pcs	Jar
705-008-BK-50	BNC connector for RG59/U (Black)	50 pcs	Jar
705-008-BK-20	BNC connector for RG59/U (Black)	20 pcs	Blisterpack
705-008-BK-10	BNC connector for RG59/U (Black)	10 pcs	Blisterpack

Assorted Wire Ferrules

Provide **high quality termination** and years of trouble free service

All ferrules are made with **tin plated copper**. Insulated ferrules plastic material is polypropylene, **heat resistant to 105°C** (UL/CSA* and RoHS)

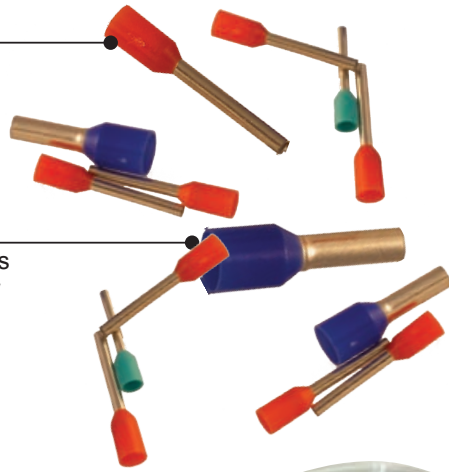

701-998

Wire Ferrule Assortment Pack

Contents

50 pcs 701-028(Insulated wire ferrule, AWG 20, orange)
100 pcs 701-011(Insulated wire ferrule, AWG 18, white)
100 pcs 701-014(Insulated wire ferrule, AWG 18, yellow)
100 pcs 701-016(Insulated wire ferrule, AWG 16, red)
50 pcs 701-022(Insulated wire ferrule, AWG 14, blue)

Individual packing

Plastic compartment wheel



Uninsulated Wire Ferrules

Model No.	AWG	mm ²	L1	d1	d2	Bag Q'ty
701-001	24	0.25	5	0.8	1.7	1000
701-129	22	0.34	5	0.85	1.8	1000
701-047	20	0.50	6	1.0	2.1	1000
701-048	20	0.50	10	1.0	2.1	1000
701-002	18	0.75	6	1.2	2.3	1000
701-136	18	0.75	8	1.2	2.3	1000
701-049	18	0.75	10	1.2	2.3	1000
701-050	18	1.00	6	1.4	2.5	1000
701-003	18	1.00	10	1.4	2.5	1000
701-051	16	1.50	7	1.7	2.8	1000
701-004	16	1.50	10	1.7	2.8	1000
701-052	16	1.50	12	1.7	2.8	1000
701-053	16	1.50	18	1.7	2.8	1000
701-054	14	2.50	7	2.2	3.4	1000
701-005	14	2.50	10	2.2	3.4	1000
701-055	14	2.50	12	2.2	3.4	1000
701-056	14	2.50	18	2.2	3.4	1000
701-057	12	4.00	9	2.8	4.0	500
701-006	12	4.00	12	2.8	4.0	1000
701-058	12	4.00	15	2.8	4.0	500
701-059	12	4.00	18	2.8	4.0	500
701-060	10	6.00	10	3.5	4.7	500
701-061	10	6.00	12	3.5	4.7	500
701-062	10	6.00	15	3.5	4.7	500
701-063	10	6.00	18	3.5	4.7	500
701-064	8	10.00	12	4.5	5.8	250

Model No.	AWG	mm ²	L1	d1	d2	Bag Q'ty
701-065	8	10.00	15	4.5	5.8	250
701-066	8	10.00	18	4.5	5.8	250
701-147	8	10.00	25	4.5	5.8	500
701-067	6	16.00	12	5.8	7.5	200
701-068	6	16.00	15	5.8	7.5	200
701-069	6	16.00	18	5.8	7.5	200
701-070	6	16.00	25	5.8	7.5	200
701-071	6	16.00	32	5.8	7.5	200
701-115	4	25.00	12	7.3	9.5	100
701-072	4	25.00	15	7.3	9.5	200
701-073	4	25.00	18	7.3	9.5	200
701-074	4	25.00	25	7.3	9.5	200
701-075	4	25.00	32	7.3	9.5	200
701-076	2	35.00	18	8.3	11.0	100
701-077	2	35.00	25	8.3	11.0	100
701-078	2	35.00	30	8.3	11.0	100
701-079	2	35.00	32	8.3	11.0	100
701-080	1/0	50.00	18	10.3	13.0	100
701-081	1/0	50.00	25	10.3	13.0	100
701-082	1/0	50.00	32	10.3	13.0	100
701-142	2/0	70.00	25	12.5	15.0	100
701-125	2/0	70.00	32	12.5	15.0	100
701-126	3/0	95.00	32	14.5	17.0	100
701-127	4/0	120.00	32	17.2	19.0	100
701-128	300 MCM	150.00	32	19.5	21.0	100
701-146	350 MCM	185.00	32	20.0	23.5	100
701-148	500 MCM	240.00	40	23.0	25.0	25

Insulated Wire Ferrules

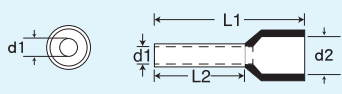

Uninsulated Wire Ferrules

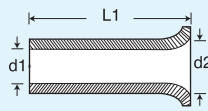

Twin Wire Ferrules

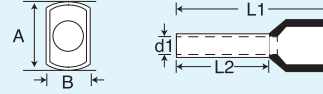

Individual packing
Poly Bag or Blister card

Insulated Wire Ferrules

Model No.	AWG	mm ²	color	L1	L2	d1	d2	Pkg Qty
701-088	26-28	0.14	Gray	10	6	0.60	1.5	500
701-088-100	26-28	0.14	Gray	10	6	0.60	1.5	100
701-025	24	0.25	Lt.Blue	10	6	0.85	1.8	500
700-025-100	24	0.25	Lt.Blue	10	6	0.85	1.8	100
701-104	24	0.25	Yellow	10	6	0.85	1.8	500
701-104-100	24	0.25	Yellow	10	6	0.85	1.8	100
701-007	24	0.25	Lt.Blue	12	8	0.85	1.8	500
701-007-100	24	0.25	Lt.Blue	12	8	0.85	1.8	100
701-026	22	0.34	Turquoise	10	6	0.85	2.0	500
701-026-100	22	0.34	Turquoise	10	6	0.85	2.0	100
701-027	22	0.34	Turquoise	12	8	0.85	2.0	500
701-027-100	22	0.34	Turquoise	12	8	0.85	2.0	100
701-008	20	0.50	Orange	12	6	1.00	2.6	500
701-008-100	20	0.50	Orange	12	6	1.00	2.6	100
701-030	20	0.50	White	18	12	1.00	2.6	500
701-030-100	20	0.50	White	18	12	1.00	2.6	100
701-013	20	0.50	White	16	10	1.00	2.6	500
701-013-100	20	0.50	White	16	10	1.00	2.6	100
701-097	20	0.50	White	14	8	1.00	2.6	500
701-097-100	20	0.50	White	14	8	1.00	2.6	100
701-098	20	0.50	Blue	14	8	1.30	2.6	500
701-098-100	20	0.50	Blue	14	8	1.30	2.6	100
701-028	20	0.50	Orange	14	8	1.00	2.6	500
701-028-100	20	0.50	Orange	14	8	1.00	2.6	100
701-131	20	0.50	Gray	16	10	1.00	2.6	500
701-131-100	20	0.50	Gray	16	10	1.00	2.6	100
701-010	20	0.50	Orange	16	10	1.00	2.6	500
701-010-100	20	0.50	Orange	16	10	1.00	2.6	100
701-029	20	0.50	White	12	6	1.20	2.8	500
701-029-100	20	0.50	White	12	6	1.20	2.8	100
701-111	20	0.75	Gray	14	8	1.20	2.8	500
701-111-100	20	0.75	Gray	14	8	1.20	2.8	100
701-011	18	0.75	White	14	8	1.20	2.8	500
701-011-100	18	0.75	White	14	8	1.20	2.8	100
701-031	18	1.00	Yellow	12	6	1.40	3.0	100
701-031-100	18	1.00	Yellow	12	6	1.40	3.0	500
701-132	18	1.00	Red	12	6	1.40	3.0	500
701-132-100	18	1.00	Red	12	6	1.40	3.0	100
701-014	18	1.00	Yellow	14	8	1.40	3.0	500
701-014-100	18	1.00	Yellow	14	8	1.40	3.0	100
701-099	18	1.00	Red	14	8	1.40	3.0	500
701-099-100	18	1.00	Red	14	8	1.40	3.0	100
701-023	18	1.00	Yellow	16	10	1.40	3.0	500
701-023-100	18	1.00	Yellow	16	10	1.40	3.0	100
701-130	18	1.00	Red	16	10	1.40	3.0	500
701-130-100	18	1.00	Red	16	10	1.40	3.0	100
701-032	18	1.00	Yellow	18	12	1.40	3.0	500
701-032-100	18	1.00	Yellow	18	12	1.40	3.0	100
701-117	18	1.00	Red	18	12	1.40	3.0	500
701-117-100	18	1.00	Red	18	12	1.40	3.0	100
701-016	16	1.50	Red	14	8	1.70	3.5	500
701-016-100	16	1.50	Red	14	8	1.70	3.5	100
701-100	16	1.50	Black	14	8	1.70	3.5	500
701-100-100	16	1.50	Black	14	8	1.70	3.5	100

All Ferrules are copper with tin plating (UL and RoHS)

Model No.	AWG	mm ²	color	L1	L2	d1	d2	Pkg Qty
701-024	16	1.50	Red	18	12	1.70	3.5	500
701-024-100	16	1.50	Red	18	12	1.70	3.5	100
701-138	16	1.50	Black	18	12	1.70	3.5	500
701-138-100	16	1.50	Black	18	12	1.70	3.5	100
701-122	16	1.50	Black	16	10	1.70	3.5	500
701-122-100	16	1.50	Black	16	10	1.70	3.5	100
701-033	16	1.50	Red	24	18	1.70	3.5	200
701-033-100	16	1.50	Red	24	18	1.70	3.5	100
701-101	16	1.50	Black	24	18	1.70	3.5	500
701-101-100	16	1.50	Black	24	18	1.70	3.5	100
701-022	14	2.50	Blue	15	8	2.20	4.2	500
701-022-100	14	2.50	Blue	15	8	2.20	4.2	100
701-102	14	2.50	Gray	15	8	2.20	4.2	500
701-102-100	14	2.50	Gray	15	8	2.20	4.2	100
701-034	14	2.50	Blue	19	12	2.20	4.2	500
701-034-100	14	2.50	Blue	19	12	2.20	4.2	100
701-113	14	2.50	Gray	19	12	2.20	4.2	500
701-113-100	14	2.50	Gray	19	12	2.20	4.2	100
701-019	14	2.50	Blue	25	18	2.20	4.2	200
701-019-100	14	2.50	Blue	25	18	2.20	4.2	100
701-035	12	4.00	Gray	16	8	2.80	4.8	200
701-035-100	12	4.00	Gray	16	8	2.80	4.8	100
701-036	12	4.00	Gray	18	10	2.80	4.8	200
701-036-100	12	4.00	Gray	18	10	2.80	4.8	100
701-145	12	4.00	Orange	18	12	2.80	4.8	200
701-145-100	12	4.00	Orange	18	12	2.80	4.8	100
701-103	12	4.00	Orange	18	10	2.80	4.8	200
701-103-100	12	4.00	Orange	18	10	2.80	4.8	100
701-037	12	4.00	Gray	26	18	2.80	4.8	100
701-038	10	6.00	Black	20	12	3.50	6.3	100
701-085	10	6.00	Yellow	20	12	3.50	6.3	100
701-020	10	6.00	Black	26	18	3.50	6.3	100
701-086	8	10.00	Red	22	12	4.50	7.6	100
701-039	8	10.00	Ivory	22	12	4.50	7.6	100
701-040	8	10.00	Ivory	28	18	4.50	7.6	100
701-087	6	16.00	Blue	22	12	5.80	8.8	100
701-121	6	16.00	White	22	12	5.80	8.8	100
701-041	6	16.00	Green	22	12	5.80	8.8	100
701-021	6	16.00	Green	28	18	5.80	8.8	100
701-042	4	25.00	Brown	30	16	7.30	11.2	50
701-140	4	25.00	Yellow	30	16	7.30	11.2	50
701-133	4	25.00	Black	32	18	7.30	11.2	50
701-043	4	25.00	Brow	36	22	7.30	11.2	50
701-137	2	35.00	Red	22	16	8.30	12.7	25
701-044	2	35.00	Beige	30	16	8.30	12.7	25
701-045	2	35.00	Beige	39	25	8.30	12.7	25
701-046	1/0	50.00	Olive	36	20	10.30	15.0	25

Twin Wire Ferrules

Model No.	AWG	mm ²	color	L1	L2	d1	A/B	Pkg Qty
701-009	2X20	0.5	Orange	15	8	1.4	5.0/3.0	500
701-116	2X20	0.5	White	15	8	1.4	5.0/3.0	500
701-089	2X18	0.75	Gray	15	8	1.7	5.5/3.0	500
701-012	2X18	0.75	White	15	8	1.7	5.5/3.0	500
701-015	2X18	1.0	Yellow	16	8	2.0	5.8/3.2	500
701-090	2X18	1.0	Red	16	8	2.0	5.8/3.2	500
701-139	2X18	1.0	Red	20	12	2.0	5.8/3.2	500
701-017	2X16	1.5	Red	16	8	2.2	6.5/3.6	500
701-143	2X16	1.5	Red	20	12	2.2	6.5/3.6	500
701-091	2X16	1.5	Black	16	8	2.2	6.5/3.6	500
701-120	2X16	1.5	Black	20	12	2.2	6.5/3.6	500
701-018	2X14	2.5	Blue	18	9	2.8	8.0/4.5	500
701-083	2X14	2.5	Blue	21	12	2.8	8.0/4.5	200
701-084	2X12	4.0	Gray	23	12	3.5	9.0/5.2	200
701-112	2X10	6.0	Yellow	26	14	4.5	11.4/6.2	100
701-135	2X8	10.0	Red	24	12	5.8	13.4/7.6	100
701-114	2X6	16.0	Blue	29	16	8.3	17.2/9.5	50

Assorted Terminals



RING TERMINALS



CLOSED END CONNECTORS



BUTT SPLICES



FEMALE DISCONNECTS



SPADE TERMINALS

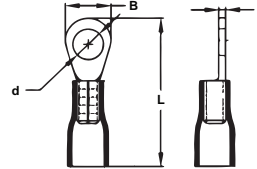
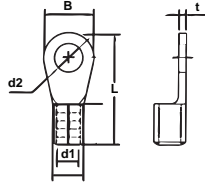

Uninsulated Ring Terminals (Brazed Seam)

AWG	Part No.	Stud Size	d1	d2	B	L	t
22-16	902-407-10	#4	.074	.126	.217	.453	.029
	902-406-10	#6	.074	.146	.260	.567	.029
	902-408-10	#8	.074	.169	.260	.567	.029
	902-409-10	1/4"	.074	.252	.457	.846	.029
16-14	902-410-10	#6	0.98	.146	.335	.661	.031
	902-411-10	#8	0.98	.169	.260	.567	.031
	902-412-10	#10	0.98	.209	.335	.661	.031
14-12	902-413-10	1/4"	0.98	.252	.472	.835	.031
	902-414-10	#10	.133	.209	.374	.768	.031
12-10	902-415-10	#8	.141	.169	.291	.728	.039
	902-416-10	#10	.141	.209	.291	.728	.039
	902-417-10	1/4"	.141	.252	.472	1.004	.039

Insulated Ring Terminals (Vinyl)

AWG	Part No.	Stud Size	B	d	L	t
22-16 (Red)	902-437-10	#6	.217	.146	.689	.030
	902-438-10	#8	.260	.169	.803	.030
	902-439-10	#10	.315	.209	.854	.030
	902-440-10	1/4"	.457	.252	1.087	.030
16-14 (Blue)	902-441-10	#6	.335	.146	.906	.031
	902-442-10	#8	.335	.169	.906	.031
	902-443-10	#10	.335	.209	.906	.031
12-10 (Yellow)	902-444-10	1/4"	.472	.252	1.106	.031
	902-445-10	#8	.291	.169	1.051	.039
	902-446-10	#10	.374	.209	1.051	.039
	902-447-10	1/4"	.472	.252	1.281	.039

• Dimensions in Inches.

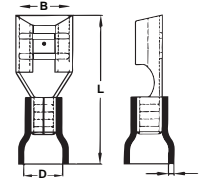
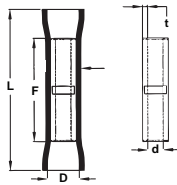
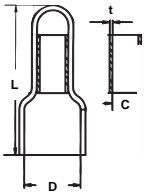

Closed End Connectors (Vinyl)

AWG	Part No.	D	C	L	T
22-16	902-402-10	.244	.102	.709	.014
16-14	902-403-10	.311	.118	.776	.014
12-10	902-404-10	.413	.157	1.004	.018
8	902-405-10	.472	.209	1.091	.037

Butt Splices Connectors (Vinyl)

AWG	Part No.	D	D	L	F	T
22-16 Red	902-418-10	.169	.067	.984	.591	.030
16-14 Blue	902-419-10	.177	.094	.984	.591	.031
12-10 Yellow	902-420-10	.256	.141	1.063	.591	.037

Female Disconnects (Push-Ons) (Vinyl)

AWG	Part No.	Tab Size	D	B	L	T
22-16 Red	902-421-10	.187 x .032	.142	.197	.748	.016
	902-422-10	.205 x .020	.142	.220	.787	.016
16-14 Blue	902-423-10	.187 x .032	.173	.197	.748	.016
	902-424-10	.205 x .020	.173	.22	.787	.016
12-10 Yellow	902-425-10	.187 x .032	.213	.197	.866	.016
	902-426-10	.250 x .032	.213	.264	.984	.016

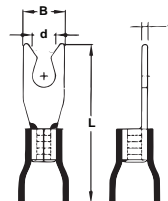
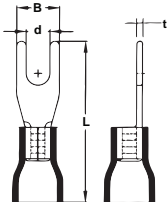

Spade Terminals (Vinyl)

AWG	Part No.	Stud Size	B	D	L	T
22-16 Red	902-448-10	#6	.224	.146	.866	.030
	902-449-10	#8	.252	.169	.866	.030
	902-450-10	#10	.209	.209	.866	.030
	902-451-10	1/4"	.252	.252	.906	.030
16-14 Blue	902-452-10	#6	.146	.146	.866	.031
	902-453-10	#8	.169	.169	.866	.031
	902-454-10	#10	.209	.209	.866	.031
12-10 Yellow	902-455-10	1/4"	.252	.252	.925	.031
	902-456-10	#8	.169	.169	1.051	.039
	902-457-10	#10	.209	.209	1.051	.039
	902-458-10	1/4"	.252	.252	1.209	.039

Locking Spade Terminals (Vinyl)

AWG	Part No.	Stud Size	B	D	L	T
22-16 Red	902-427-10	#6	.224	.146	.866	.030
	902-428-10	#8	.286	.169	.866	.030
	902-429-10	#10	.315	.209	.906	.030
16-14 Blue	902-430-10	#6	.244	.146	.866	.031
	902-431-10	#8	.283	.169	.866	.031
	902-432-10	#10	.315	.209	.866	.031
12-10 Yellow	902-433-10	#6	.319	.146	1.051	.039
	902-434-10	#8	.323	.169	1.051	.039
	902-435-10	#10	.354	.209	1.051	.039
	902-436-10	1/4"	.472	.252	1.209	.039

▶ Modular Plugs



4P4C



6P4C



8P8C



10P10C

To Select Proper Plug	
Step 1	Pick the number of positions in block and number of pins loaded in block.
Step 2	Choose flat or round cable
Step 3	Choose Stranded or Solid conductors (wire)
Step 4	Choose Premium Grade or Economy Grade - Gold thickness is only difference
Step 5	Choose Pack Quantity (retail pack of 50 pcs or Bulk bag of 1,000 pcs.)

			Premium Grade 50 uin Gold		Economy Grade Thin Gold Flash	
Pos/ Contacts	Cable Type	Wire Type	Clamshell (50pcs)	Poly bag (1000pcs)	Clamshell (50pcs)	Poly bag (1000pcs)
4P4C	Flat	Stranded	702-001	744-FA50	702-059	744-FA03
6P4C	Round	Standed	-	-	702-063	764-RA03
	Round	Solid	702-018	764-RX50	-	-
8P8C (CAT5e)	Flat	Standed	702-008	788-FA50	702-066	788-FA03
	Round	Standed	702-009	788-RA50	702-067	788-RA03
	Flat	Solid	702-021	788-FX50	702-079	788-FX15
	Round	Solid	702-022	788-RX50	702-080	788-RX15
10P10C	Round	Stranded	702-013	700-RA50	-	-

▶ CAT 6-100 RJ45 Cat.6 Plug w/Inserter 100pk

- CAT 6-100 connectors can be used for both CAT5 and CAT6 stranded RJ45 Cables. These connectors come with insertion guide for ease of use.
- Weight: 0.3 lbs



▶ Telecom Splices

- Use Crimp Tool P/N 100-008 or CP-148



UR AWG
26~20

UG AWG
19~26

UY AWG
26~22

Individual
packing
Box or Blister Pack

- Silicone gel filled for protection from elements

Model No.	Description	Package Quantity
703-001	UY Connectors	1,000 Pc. Outer box with ten 100pc box
703-003	UY Connectors	100 Pc. Clamshell
703-005	UY Connectors	25 Pc. Clamshell

Model No.	Description	Package Quantity
703-002	UR Connectors	1,000 Pc. Outer box with ten 100pc box
703-004	UR Connectors	100 Pc. Clamshell
703-006	UR Connectors	25 Pc. Clamshell

Model No.	Description	Package Quantity
703-007	UG Connectors	1,000 Pc. Outer box with ten 100pc box
703-008	UG Connectors	100 Pc. Clamshell
703-009	UG Connectors	25 Pc. Clamshell

WIRING INSTALLATION



Eclipse ProSeries
FISH TAPE

▶ 902-355/902-460 Heat Shrink Tubing

Used for electrical insulation, bundling, and wire identification purposes in a variety of home, commercial, and industrial applications.

- Slides easily over small inline splices and connectors.
- Can shrink down to 50% of its original diameter to fit snugly over any wire, hose or cable management project.
- Ideal way to terminate ends of Braided Sleeving, creating a tight, professional finish.



160 pieces: 4" lengths	
1/16"	60 PC
3/32"	35 PC
1/8"	25 PC
3/16"	20 PC
1/4"	10 PC
3/8"	10 PC



**902-355
(Black)**

**902-460
(Asst colors)**

▶ 900-147/900-148/900-149 Steel Fish Tapes - 1/8" wide



900-147



900-148



900-149

- Made from flexible spring steel and black finish.
- Equipped with durable plastic container and slide handle.
- Easy to thread through the pipe and pull out the electric cable.

Model No.	Steel tape size	Individual packing
900-147	50 Feet	PE shrink
900-148	100 Feet	PE shrink
900-149	200 Feet	PE shrink

▶ 902-197 Fiberglass Fish Tape



Fiberglass tape size	Individual packing
150 Feet	PE shrink

DK-2053A Fiberglass Push/Pull Rod Set (10 Pcs/set)

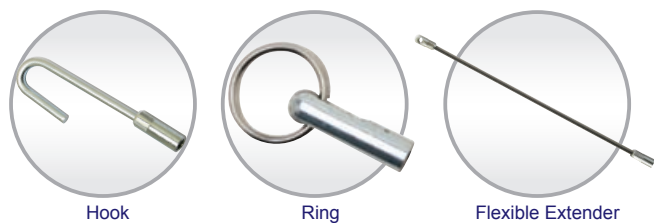
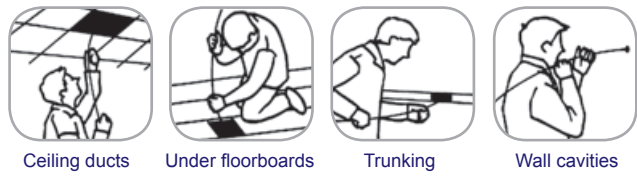

Replacement Parts: 9DK-2053A-B
(3pcs/set Includes: Hook, Ring & Extender)



33 Feet

Description	Individual packing
3.28 feet, 10pcs/set	PVC tube

- Ideal for running multi-purpose cable in hard-to-reach area such as behind walls, up through crawl spaces, and under floors.
- 10 pcs, 1M/3.28Ft each
- Diameter 5mm±0.2mm (13/64"±0.008")

902-470/902-471 Cable Routing Tools - TuffStik & TuffStik Jr.

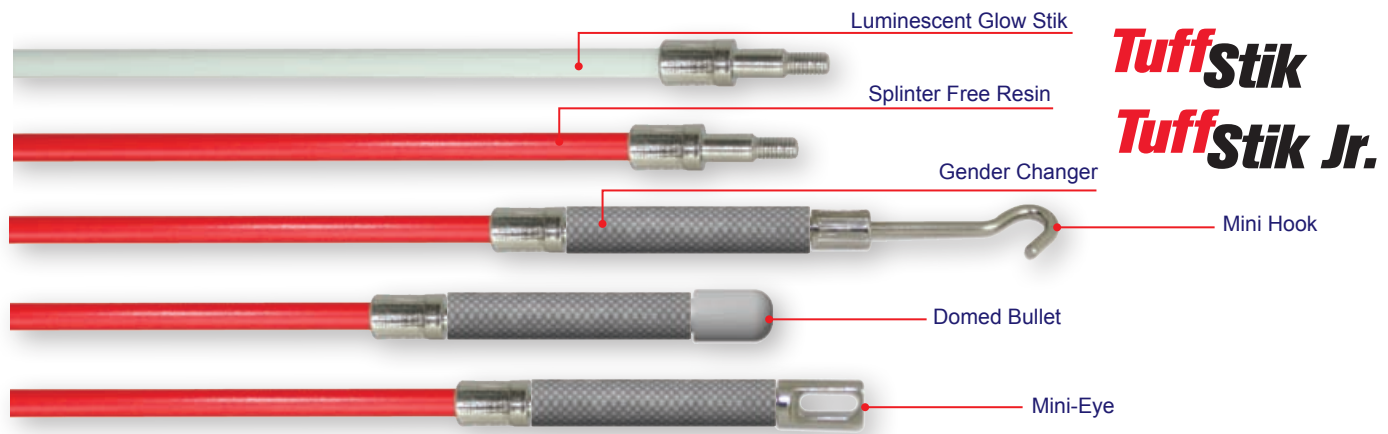

TuffStik
TuffStik Jr.

- Splinter-free resin eliminates dangerous splinters.
- Includes luminescent glow stik
- Non-Conductive
- Easy to connect.
- Very flexible

	Tuff Stik Jr.	Tuff Stik
Part No.	902-470	902-471
Length	15 FT	30 FT
5 FT red 3/16 stiks	X2	X5
5 FT luminescent 3/16 stiks	X1	X1
Mini-hook		902-475
Mini-eye		902-476
Domed bullet		902-478
Gender changer		902-477
5 FT packaging tube		

902-472 Cable Routing Tools - 18 FT Telescopic Push / Pull Rod With Hook

- Extendable pole with durable polyester resin baked enamel coating.
- Ideal for electricians and cable installers.
- More rigid than rod based tools for greater control over long reaches.
- Includes shoulder carrying strap.



QuikStik

Cable Ties



▶ Cable Ties

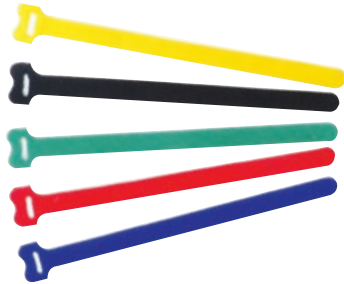

Hook and Loop Cable Ties (Packs of 25)

Description	Part No.	Color	QTY	PKG
8" Hook and Loop Cable Ties	900-098-BK	Black	25	Poly bag with header
	900-098-BU	Blue		
	900-098-GN	Green		
	900-098-OR	Orange		
	900-098-RD	Red		
	900-098-WH	White		
	900-098-YL	Yellow		

Nylon Cable Ties (Packs of 100)

Description	Part No.	Color	QTY	PKG
Nylon Cable Ties 4"x3/32"	902-012	Neutral	100	Poly bag with header
	902-019	Black		
Nylon Cable Ties 7-7/8"x3/32"	902-015	Neutral		
	902-022	Black		
Nylon Cable Ties 5-1/2"x9/64"	902-013	Neutral		
	902-020	Black		
Nylon Cable Ties 7-7/8"x9/64"	902-016	Neutral		
	902-023	Black		
Nylon Cable Ties 7-1/2"x3/16"	902-014	Neutral		
	902-021	Black		
Nylon Cable Ties 11-3/4"x3/16"	902-017	Neutral		
	902-024	Black		
Nylon Cable Ties 14-1/2"x3/16"	902-018	Neutral		
	902-025	Black		

Hook and Loop Cable Tie Assortment (Packs of 15)

Description	Part No.	Color	QTY	PKG
Colors: Black, Blue, Green, Red & Yellow	900-098-AST	Assorted	15	Poly bag with header

▶ Hook and Loop Cable Tie Material

Description	Width	Part No.	Color	PKG
Hook and Loop Cable Tie Material (Bulk Roll, 50')	3/4" wide	902-305	Black	Poly bag with header
		902-386	Red	
		902-387	Blue	
	1/2" wide	902-035	Black	
		902-388	White	
		902-389	Blue	



▶ CP-391 All In One Cable Tacker



Interchangeable staple guide plate

- For insulated staples only.



STEP 1
Press the staple feeder downward and remove from its channel.



STEP 2
Load a strip of staples into the channel.



STEP 3
Slide in the staple feeder and push it up to its locked position.



CP-391-1

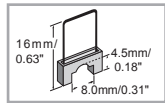

- Round Cable
Height: 4mm~6mm (0.16\"~0.24\")
- Flat Wire
Height: 2.5mm~4.0mm
Width: Below 8.0mm

CP-391-2

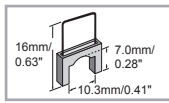

- Round Cable
Height: 6mm~8mm (0.24\"~0.31\")
- Flat Wire
Height: 4.5mm~6.3mm (0.18\"~0.25\")
Width: Below 10.3mm (0.41\")

- All in one cable tacker can work with different kinds of round cables and flat wires.
- Easy way to change different staple guide plates to match different staples (CP-391-1 or CP-391-2)

Material	OAL. (mm/inch)	Replacement staples	Individual packing
Body			
ABS	180x30x148 7.1x1.2x5.8	CP-391-1 (200pcs/pack) CP-391-2 (200pcs/pack)	Blister card

▶ CP-392 Heavy Duty 3 In 1 Tacker



- Works with Arrow brand T25 staples.



- 1.Flat crown staples 4-14mm(5/32\"-9/16\")
200pcs
- 2.Round crown staples 10-12mm(3/8\"-1/2\")
200pcs
- 3.Brad Nails 10-14mm(3/8\"-9/16\") 200pcs

- Easy-squeeze product works overtime as a staple gun, brad nailer, cable tacker and wire tacker
- Fastens 3 different types of staples: flat crown staples, round crown staples and brad nails
- Ideal for upholstery, wood working, ceiling tiles, rack & roofing
- Adjustable punch force to match different material hardness.
- Less force to squeeze and more driving power
- Non-slip grip and quick jam release
- Made of all carbon steel construction.

CP-392-3 Flat Crown Staples

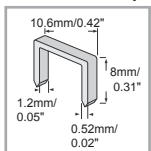

500pcs/box

CP-392-4 Round Crown Staples

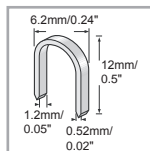

500pcs/box

CP-392-5 Brad Nail

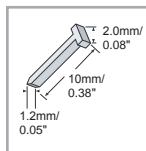

1000pcs/box

Material	OAL. (mm/inch)	Replacement staples	Individual packing
Body			
Carbon steel	160x23x140 6.3x0.9x5.5	CP-392-3 (500pcs/box) CP-392-4 (500pcs/box) CP-392-5 (1000pcs/box)	Blister card

▶ CP-382 Cable Tie Gun



- Neatly cuts end of cable tie off
- Adjustable tension control



Material		HRC	Application	OAL. (mm/inch)	Individual packing
Body	Blade				
Aluminum	S45C	Cutter 48°±2°	Cable tie from 3/32"~3/16"(2.2~4.8mm) and thickness up to 1.6mm	160/6.3	Blister card

▶ CP-383 Cable Tie Gun



Features:

- Adjustable tension control can be used for a variety of style cable ties
- Consistent flush cut with each use
- Durable die-cast steel construction

Cable Tie:

- Thickness up to 1.3mm(0.05")
- Width up to 4.6mm(0.18")



Material	O.A.L (mm/inch)	Individual packing
Steel	168/6.6	Blister card

▶ CP-385 Cable Tie Fasten Tool



- Tension adjustment allows the user to adapt the tool to the size of the tie
- Cutting lever design to cut-off the excess tie for easy operation



Tension



Cutting

Material		Application	OAL. (mm/inch)	Individual packing
Body	Blade			
Aluminum	S45C	cable ties thickness 3 mm and width 12mm	191/7.5	Blister card

▶ 902-321 Stainless Steel Cable Tie Gun

- Ideal for tensioning and cutting off stainless steel cable ties both in ball lock and ladder types.
- Heavy duty, two stage manual tensioning tool for easy operation
- OAL: 8.2"

Ideal for Stainless Steel Cable Ties

Cable tie holder is specially made of SKD11 steel and CNC ground

Cutting blade is made of SKD11 and CNC ground

Cable control bar

Self return spring design

Made of Carbon Steel

Non-slip TPR handles



Tensioning and cutting off stainless steel cable ties



Suitable for most application fields of stainless steel cable ties. And up to 12mm wide.

Individual packing
Blister Card

STORAGE/ INSTRUMENT CASES



SB-3218 / SB-4121 Multi-Function Tool Box With Removable Tote Tray



- Impact resistant
- Lift out tray
- Easy organization, easy to find

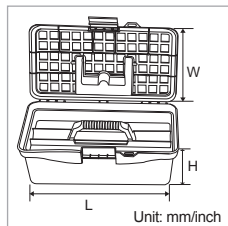
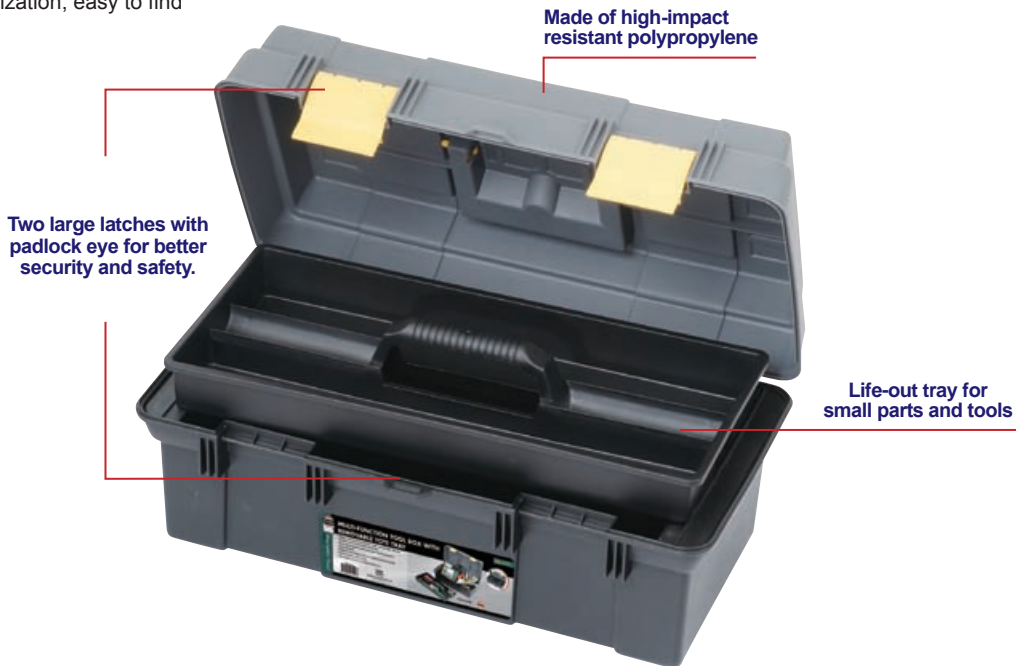

Model No.	Material	Loading Capacity	Dimension (LxWxH) (mm/inch)	Individual packing
SB-3218	polypropylene	5Kg/11Lb	315x175x130/ 12.4x6.9x5.1	Color label shrink
SB-4121		10Kg/22Lb	410x210x185/ 16.1x8.2x7.2	

SB-2918 Multi-Function Tool Box With Storage Tray



- Made from high-impact resistant polypropylene.
- Heavy-duty tool box is ideal for home, office, auto or craft.
- Portable lift-out plastic storage box inside, great for keeping small items organized
- Comfortable and rugged handle for convenient carrying.

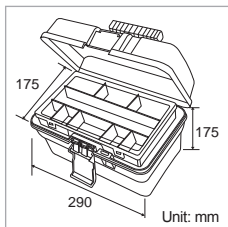

Material	Loading Capacity	Dimension (LxWxH) (mm/inch)	Individual packing
polypropylene	5Kg/11Lb	290x175x175/ 11.4x6.9x6.9	Color label shrink

SB-3428SB / SB-4536B Service Case



Double sided opening



SB-3428SB

- Double sided opening
- Adjustable dividers up to 15 compartments and 5 large and 5 small removable inserts in the other side for storage flexibility.



SB-4536B

- 6 large and 6 small removable inserts for storage flexibility
- Made from high impact resistant polypropylene and poly styrene, sturdy and durable
- Properly divided spaces reach the different needs of any small components.
- Integrated handle and two locks for convenient carrying.
- Easy to store, easy to find

Model No.	Material	Dimension (LxWxH) (mm/inch)
SB-3428SB	polypropylene + polystyrene	340x280x80 13.6x11.0x3.1
SB-4536B		450x355x75 17.7x14.0x3.0

Individual packing
Color label shrink

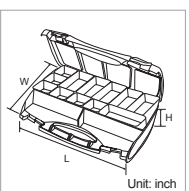

900-164A/900-164B Instrument Cases



• The durable ABS plastic cases allow for various PCB mounting positions. Adhesive feet and screws are included, choose from 2 sizes. 900-164B has ventilation slots and speaker recess.

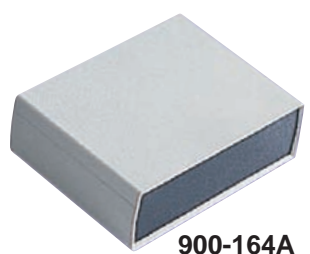

900-164A



900-164B

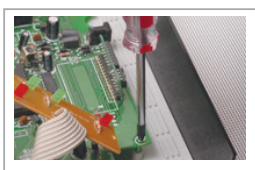

Demo only

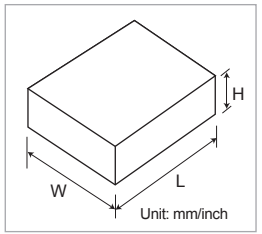

Model No.	Material	L(mm/inch)		W(mm/inch)		H(mm/inch)		Individual packing
		OD	ID	OD	ID	OD	ID	
900-164A	ABS	200/7.9	197/7.8	158/6.2	146/5.7	64/2.5	58/2.3	Poly bag
900-164B		253/10.0	250/9.8	190/7.2	176/6.9	82/3.2	76/3.0	

900-162A/900-162B/900-162C Die Cast Aluminum Enclosures



• The heavy-duty enclosures are made of high quality die-cast aluminum and have channeled walls for easy PCB mounting.
• These enclosures act as excellent heat sink.
• Easy assembly screws included.



900-162A



900-162B



900-162C

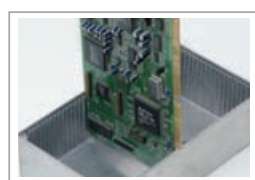

Demo only

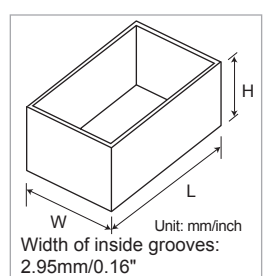

Model No.	Material	L(mm/inch)		W(mm/inch)		H(mm/inch)		Individual packing
		OD	ID	OD	ID	OD	ID	
900-162A	Aluminum	101/4.0	97/3.8	50.6/2.0	46.6/1.8	20.7/0.81	18.8/0.74	Shrink packing
900-162B		121/4.8	116.9/4.6	66.1/2.6	62/2.4	35.4/1.4	33.5/1.3	
900-162C		193.5/7.6	187.5/7.4	112.4/4.4	106.5/4.2	56.2/2.2	54/2.1	

▶ 902-497 **Compartment Storage Box**

- Adjustable compartments for multiple uses



Material	Dimension (mm/inch)	Individual packing
PP	35.8x23.5x6 / 1.4x0.9x0.2	Shrink packing

▶ 900-040 **Utility Component Storage Box**

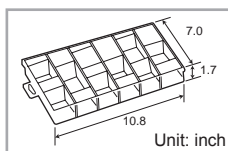

Material	Dimension (mm/inch)	Individual packing
PP	275x177x42.5/10.8x7.0x1.7	Shrink packing

▶ 900-039 **Utility Component Storage Box**

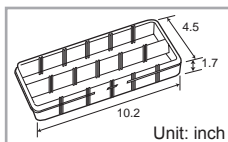

Material	Dimension (mm/inch)	Individual packing
PP	260x115x43.5/10.2x4.5x1.7	Shrink packing

▶ 902-113 **Utility Component Storage Box**

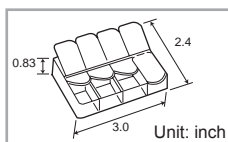
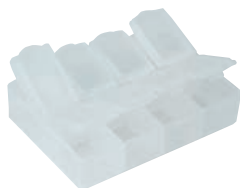

Material	Dimension (mm/inch)	Individual packing
PP	76x61x21/3.0x2.4x0.83	Shrink packing

▶ 900-091A **Parts Tubes**



Material	Dimension (mm/inch)	Individual packing
PP	∅20x130/∅0.79x5.1	Clamshell (3pcs/pack)

▶ SB-2419 **Storage Box**



- Tight seal between top and compartments prevents small components from being mixed while closed.

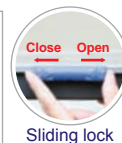
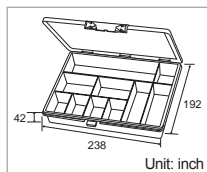

Material	Dimension (mm/inch)	Individual packing
Polypropylene	238x192x42 9.4x7.6x1.7	Color label shrink

▶ 900-041 **Utility Component Storage Box**

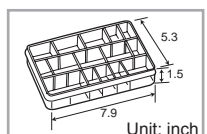

Material	Dimension (mm/inch)	Individual packing
PP	200x135x39/7.9x5.3x1.5	Shrink packing

▶ 902-112 **Utility Component Storage Box**

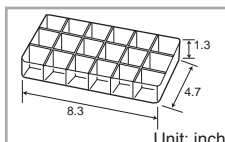

Material	Dimension (mm/inch)	Individual packing
PP	210x119x32/8.3x4.7x1.3	Poly bag

▶ 902-114 **Utility Component Storage Box**

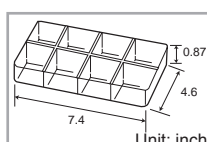

Material	Dimension (mm/inch)	Individual packing
PP	187.5x117x22/7.4x4.6x0.87	Poly Bag

▶ 900-043 **Utility Component Storage Box**

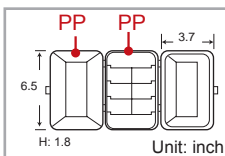

Material	Dimension (mm/inch)	Individual packing
PP/PE	165x95x45/6.5x3.7x1.8	Shrink packing

TOOL CASES



▶ **TC-265 / TC-266 / TC-267 Heavy Duty Waterproof Case**



water-tight seal for equipment protection



Comes with Pick and Pluck foam.

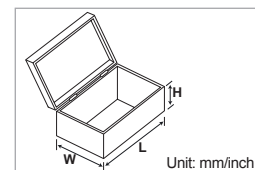

Model No.	Material	Loading Capacity	I.D.(LxWxH) (mm/inch)	O.D.(LxWxH) (mm/inch)	Individual Packing
TC-265	ABS	20 Kg/44Lb	430x290x163 17x11.4x6.4	455x340x175 18x13.3x7	Color label shrink
TC-266		15 Kg/33Lb	330x217x160 13x8.5x6.3	340x260x170 13.3x10.2x6.7	
TC-267		15 Kg/33Lb	300x180x153 11.8x7.1x6	328x232x170 13x9.1x6.7	

▶ 900-262 Heavy-Duty ABS Case With Wheels And Telescoping Handle

- Heavy-duty black scuff resistant molded ABS thermoplastic forms the tough shell of this case.
- Extruded aluminum rim, drawbolt key locks and strong molded handle.
- Complete with one removable pallet and removable interior dividers.
- Locking telescoping handle extends to 1000mm.
- Loading capacity : max 12kg/26Lb
- Rotationally molded heavy-duty polyethylene shell.



Rugged and comfortable grip handle

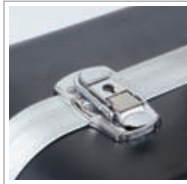

Key locks for maximum security



Standard equipment for easy opening and closing.

Assemble

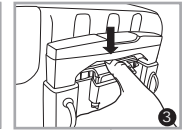
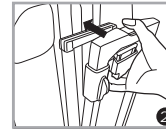
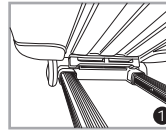

Material	Loading Capacity	Dimension (mm/inch)	Individual Packing
ABS	12Kg/26Lb	456x190x335/18.3x7.5x13.2	Color Box

▶ TC-131 Heavy Duty Luggage Cart



- Fold flat for easy storage.
- Open quickly to hold up to 150lbs/68kg.
- Soft comfortable grip hand.
- Extra sturdy and lightweight construction.
- 125mm/4.9" large heavy duty wheels to go up and down stairs and curbs easily.
- Includes 2pcs on 100cm/3.9" stretch band.



Loading Capacity	Material		
68Kg (150lbs)	Body: Metal Platform: Aluminum steel Wheel: PP+TPU		
Dimension (mm/inch)	Weight (kg)	Individual Packing	
Fold: 385x 64x 763/15.2x2.5x30 Open: 385x 420x 1010/15.2x16.5x39.8 Platform: 385x280x6/15.2x11x0.24	3.5	Bulk	

▶ TC-765 Aluminum Frame Drawer Case

- Made of rugged plastic for strength and durability .
- Sturdy aluminum frame construction.
- The drawer locks automatically when lid is closed to prevent slide out for easy mobility.
- Ball-bearing slides make drawer easy to open and close tightly.
- Non-slip lining helps you to keep tools in place.
- Cushioned carrying handle for user comfort.
- Comes with drawers at the bottom perfect to store small gadgets and tiny tools.



Drawer auto-locking design when lid is closed to prevent slide out Key locks for maximum security Heavy duty metal protective corners Ball-bearing slides make drawer easy to open and close tightly

Size	L (mm/inch)	W (mm/inch)	H1 (mm/inch)	H2 (mm/inch)	A	Individual packing
O.D	430/16.9	300/11.8	163/6.4	57/2.2	90°	Color box
I.D	410/16.1	280/11.0	70/2.8	49/1.9		
I.D(Drawer)	337/13.3	255/10.0	40/1.6	-		

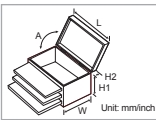

▶ 900-048 Aluminum Frame Tool Case W/1 Pallet

- Complete with one removable pallet and removable interior dividers
- Lining and partitions: EVA



3 hinges reinforce construction Rugged and comfortable grip handle Heavy duty metal protective corners Bag with rivet design, more durable

Material	Size	L (mm/inch)	W (mm/inch)	H1 (mm/inch)	H2 (mm/inch)	A	Second Pallet	Individual packing
Frame: Aluminum	O.D	458/18.0	330/13.0	90/3.5	60/2.4	97°	900-045	Plain box + Color box
	I.D	434/17.1	308/12.1	82/3.2	53/2.1			

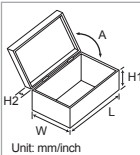

▶ 900-141 ABS Carrying Tool Case W/2 Pallet

- Complete with two removable pallets and removable interior dividers.



Deluxe die-cast chrome golf grip handle Key locks for maximum security Bag with rivet design, more durable

Material	Size	L (mm/inch)	W (mm/inch)	H1 (mm/inch)	H2 (mm/inch)	A	Individual packing
ABS	O.D	435/17.1	310/12.2	80/3.14	65/2.6	105°	Color box
	I.D	420/16.5	293/11.5	70/2.8	60/2.4		

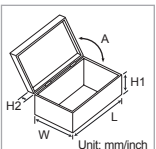

▶ **900-203 Aluminum Frame Tool Case**

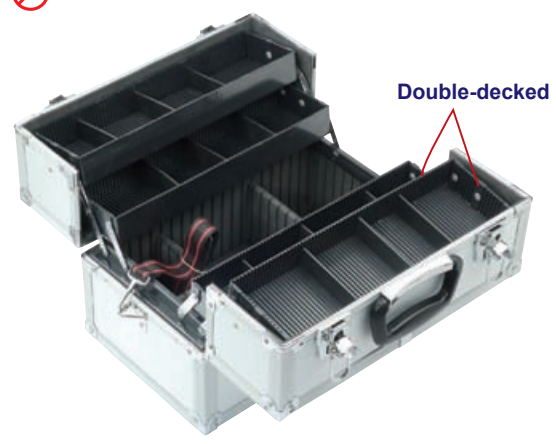

- With removable interior dividers
- Lining and partitions: EVA

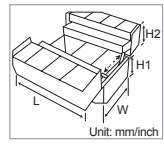

Size	Material	L (mm/inch)	W (mm/inch)	H1 (mm/inch)	H2 (mm/inch)	Individual packing
O.D	Frame: Aluminum	360/14.2	220/8.7	120/4.7	110/4.3	Plain box + Color label
I.D		335/13.2	200/7.9	110/4.3	85/3.3	

▶ **900-199 ABS Carrying Tool Case W/1 Pallet**



- Attractive and functional multipurpose cases**
- Functional for both personal and professional business.
 - Complete with one removable pallet and removable interior dividers
 - Both the tool pallet and dividers are removable.
 - Injection molding tool case stands. Aluminium corner frames to protect tools.
 - Lining and partitions: EVA

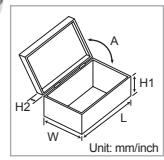

Size	Material	L (mm/inch)	W (mm/inch)	H1 (mm/inch)	H2 (mm/inch)	A	Individual packing
O.D	ABS	463/18.2	331/13.0	96/3.8	75/3.0	98°	Color box
I.D		453/17.8	323/12.7	90/3.5	67/2.6		

▶ **900-011 Aluminum Frame Tool Case W/1 Pallet**



- Complete with one removable pallet and removable interior dividers
- Lining and partitions: EVA

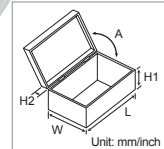

Size	Material	L (mm/inch)	W (mm/inch)	H1 (mm/inch)	H2 (mm/inch)	A	Second Pallet	Individual packing
O.D	Frame: Aluminum	458/18.0	330/13.0	101/4.0	49/1.9	97°	900-045	Color box
I.D		438/17.2	312/12.3	95/3.7	41/1.6			

▶ 900-054 2 In 1 Zipper Bag W/2 Pallet



Top view



Interior pocket



Material	L (mm/inch)	W (mm/inch)	H (mm/inch)	Individual packing
PVC leather	400/15.7	300/12	120/4.7	Poly bag

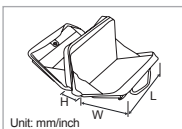

▶ 900-052 Heavy Duty Zipper Bag



Front Side



Back Side

Material	L (mm/inch)	W (mm/inch)	H (mm/inch)	A	Individual packing
PVC leather	435/17.1	325/12.8	90/3.5	93°	Color box



▶ 900-225 Blow Molded Case With Pre-Cut Soft Foam

- Material: H.D.PE



Inside dimensions:
 Base 15-5/8" X 8-3/4" at the top, 15-1/4" X 8-1/2" at the bottom, 2-1/2" deep
 Top 16-1/2" X 9-5/8", 3/4" deep

L (mm/inch)	W (mm/inch)	H (mm/inch)	Individual packing
442/17.4	279/11.0	89/3.5	Color Label



▶ 902-118 **Zipper Bag W/2 Pallets**

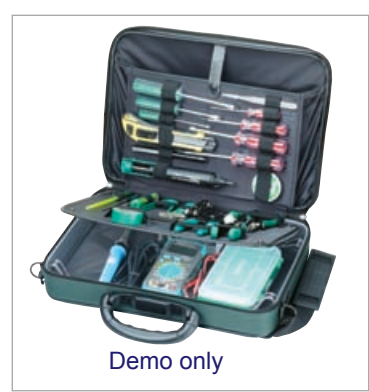
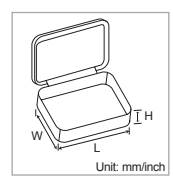

Material	L (mm/inch)	W (mm/inch)	H (mm/inch)	Individual packing
PVC leather	390/15.4	280/11.0	70/2.8	Color box

▶ 902-119 **Tool Bag**

• Intensive structure for strap, zipper and handle designed to enhance the durability, ideal for student market.

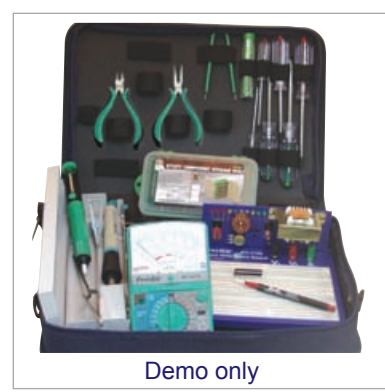
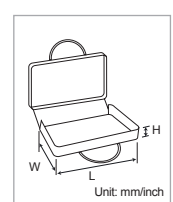
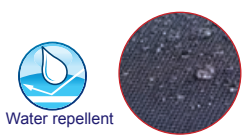

Material	L (mm/inch)	W (mm/inch)	H (mm/inch)	Individual packing
600D polyester	390/15.4	260/10.2	110/4.3	Poly bag

Convenient • Portable • Durable

▶ 900-260 **Tool Bag**

• Multi function bag with 4 inner layers ideal for storing tools, books, mobile computers, clothes, etc.

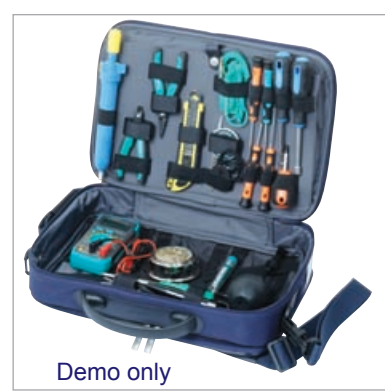
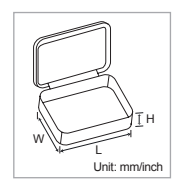

Material	L (mm/inch)	W (mm/inch)	H (mm/inch)	Individual packing
600D polyester	400/15.7	275/10.8	90/3.5	Poly bag

Convenient • Portable • Durable

▶ ST-3216 Multi-Function Business Backpack

• Decompress • Ventilate • Comfortable • Large capacity

- Airflow back design provides extra soft comfort back cushion, good ventilation and maximum back support.
- Perfect ergonomic shoulder strap provides comfort, ventilation and maximum back support.



Backpack



15 kg
Heavy duty



Earbud hole



Laptop protection



Good Ventilation



Light weight

Large Capacity

The central multi components, interior pocket organizer provides extensive capacity for laptop, pad, smartphones, pens, CDs, tools and more. The mesh side pockets are perfect for water bottles, coffee mugs or other side pockets items.



Cushion back
good ventilation



Ergonomic shoulder straps

Earbuds pass-through hole

Cushion back
good ventilation

Capacity adjustment strap

Quick access front and side pockets

Removable chest belt

Material	Dimensions(mm/inch)	Individual packing
600D polyester	310×160×470/ 12.2x6.3x19.0	Plastic bag+Hanging card

▶ MTB-1 Mechanic's Tool Bag

- Material: 600D Polyester
- Rugged construction
- Heavy-duty zipper
- Sturdy padded handles
- Hard bottom to maintain shape
- Soft sides to allow flexibility
- 13 pocket holes for versatility

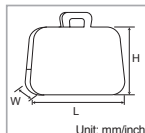

Unit: mm/inch

Demo only

Material	L (mm/inch)	W (mm/inch)	H (mm/inch)	Individual packing
600D Polyester	305/12.0	152/6.0	165/6.5	Poly bag

▶ 900-246 Soft Sided Tool Pouch



- Keep your tools and supplies handy.
- Made from strong durable fabric.
- complete with universal tool belt system.



Demo only
Dual purpose belt for easy carrying on shoulder or waist

Size	L (mm/inch)	W (mm/inch)	H (mm/inch)	Individual packing
O.D	305/12.0	235/9.3	95/3.7	Poly bag + Hanger

ST-5208 Tool Pouch

- Various styles for multiple tool usage.
- Different size compartments designed for easy tools classify and storage.
- Made of lightweight and durable polyester provides extra strength and carrying comfort.
- Use your own belt or use our ST-5504 belt.



Water repellent



Demo only

Material	Loading capacity	Dimension (mm/inch)	Individual packing
600DX600D Polyester	4kg	169x290x50/6.7x11.4x2.0	Poly bag + Hanger

ST-5203 Power Tool Holster

- Made of lightweight and durable polyester.
- Provides extra strength and carrying confort.



Water repellent

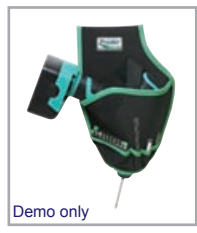

Demo only

Material	Loading capacity	Dimension (mm/inch)	Individual packing
600DX600D Polyester	3kg	190x295x60/7.5x11.6x2.0	Poly bag+Hanger

902-312 4 Pocket Pouch

- Made of 600D polyester
- 3 mesh pockets for light tools
- Ideal for packing pliers with a padded & reinforced pouch design



Demo only



Material	Dimension (mm/inch)	Individual packing
600D Polyester	229x102mm/9.4"x4.0"	Poly bag+Hanger

9ST-902 Zipper Bag



Demo only

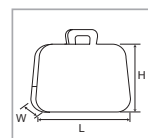

Material	L (mm/inch)	W (mm/inch)	H (mm/inch)	Individual packing
PVC leather	260/10.24	170/6.69	38/1.5	Poly bag

ST-5504 Tool Belt with Safety Lock



Extra lock design, prevent belt loosing

- High quality, heavy duty 600 denier polyester for durability
- Lightweight design with all stress point strengthened by high density webbing
- Adjustable to meet different users' demands.
- Use with our ST-5208 pouch.



Material	Loading capacity	Dimension (mm/inch)	Individual packing
Polypropylene	15kg	Width: 50mm/2.0" Length: 1600mm/63"	Poly bag + Hanger

ST-5601 Magnetic Wrist Band



Demo only

- Powerful magnet lifts: 1kg



Water repellent



Material	Dimension (mm/inch)	Individual packing
600DX600D Polyester	Width: 5cm / Length: 30cm (Width: 2.0" / Length: 11.8")	Poly bag+Hanger

TOOL KITS



Pro'sKit[®] Professional Tool Kits

Pro'sKit has more than hundred items tool kit in 12 application fields, includes electronics , computer, electrical, telecom, networking, fiber optic, solar, VDE insulated tool, CATV/CCTV, 3C products, Home DIY & educational...etc. Not only wide range of applications, we also built up the depth of each application with basic small kit, general popular kit & professional completed kit at different price range.



Electronics/Electrical

PAGE

189

PAGE
192

VDE



Socket

PAGE

195

PAGE
196

Solar



Networking

PAGE

203

▶ **902-121** 8 PC Compact Tool Kit

902-121 contents	
	Dual color long nose plier 136mm (5.4")
	Dual color diagonal cutting Plier 115mm (4.5")
+	Electronic screwdriver: #00, #0, #1
-	Electronic screwdriver: 1.4, 1.8, 2.4
+	Double-end reversible screwdriver #2/6 mm
	Fine tip straight tweezer
	Zipper carrying bag

- Case size: 207x127.5x40mm (8.15"x5.02"x1.57")
- Individual packing: Color sleeve shrink



▶ **500-025** 10 PC Compact Tool Kit

500-025 contents	
	Long nose plier 135mm (5.3")
	Diagonal cutting plier 110mm (4.3")
	Fine tip straight tweezer
-	Pro-soft s/d 3.2x75mm (3.2x3.0")
+	Pro-soft s/d #0x75mm (#0x3.0")
	Precision screwdriver 2.4mm
	Precision screwdriver #0
	Needle file flat
	Needle file round
	Utility knife (3 blades self loading)
	Zipper carrying bag

- Case size: 205x144x35mm (8.1"x5.7"x1.4")
- Individual packing: Inner box & Color label shrink



▶ **PK-9112** Pro Tech Tool Kit



Ideal for opening of tablets, notebooks, electronic device cases and most branded video games such as Apple, HTC, Samsung, Sony, Microsoft, Nintendo, Sega and more.

Contents	
Opening and prying tools	Prying Paddle (30.5x30.5x30.5mm / 1.2x1.2x1.2")
	Opening Lever(POM)(88.7mm / 3.5")
	Opening Lever(POM)(84.4mm / 3.3")
	Suction Cup Ø36mm
	Point-Blade Solder Aid Tools (155mm/6.1")
	Spudger Solder Aid Tools (140mm/5.5")
	Fork-Blade Solder Aid Tools (173mm/6.8")
	Double-end Metal Spudger (185mm/7.3")
	Metal spudger tool (123x12mm/4.8x0.5")
	super fine tip straight (120.5 mm/4.7")
Tweezers	fine tip curved (120.5 mm/4.7")
	super fine tip straight (120.5 mm/4.7")
	super fine tip straight (120.5 mm/4.7")
Static protection tools	Wrist Strap 10FT, to avoid sensitive electronic components, from electrostatic damage.
	Ruler 6", Precision Knife, SD-9828 58pcs Driver Kit
	Tool bag (233x150x55 mm/9.2x6.0x2.2")

Individual packing: Color Box



The P2/P5/P6 pentalobe tips are special for Apple products.

The TS3.5/TS4.5 Torx Plus® sockets are for Nintendo, SONY, SEGA products.

• NOTE : For quality reason. we reserve the right to change the above specifications without notice.

▶ **500-047** 13 PC Basic Electronics Kit



500-047 contents
Lineman's plier 160mm (6.3")
Side cutting plier 160mm (6.3")
Long nose plier 165mm (6.5")
6" Adjustable wrench
Desoldering wick
Solder core 63%, SN
⊖ Pro-soft screwdriver 3.0x100mm (3.0x4.0")
⊕ Pro-soft screwdriver #0x100mm (#0x4.0")
⊕ Pro-soft screwdriver #2x100mm (#2x4.0")
⊖ Pro-soft screwdriver 5.0x100mm (5.0x4.0")
⊕ Pro-soft screwdriver #1x100mm (#1x4.0")
Convertible soldering iron/gun 110V
Fine tip straight tweezer
Zipper carrying bag

- Case size: 195x305x50mm (7.7"x12.0"x2.0")
- Individual packing: Color sleeve shrink

▶ **500-003** 28 PC Computer Service Tool Kit



500-003 contents
Long nose plier 135mm(5.3")
Diagonal cutting plier 110mm(4.3")
Fine tip straight tweezer
3 pcs Soldering aid tools
6" Adjustable wrench
Quick heat ceramic soldering iron 110V
Screwdriver handle
⊖ Pro-soft s/d 5.0x75mm(3.0")
⊕ Pro-soft s/d #1x75mm(3.0")
Desoldering wick
Crimping tool (inch)
Desoldering pump
IC extractor
3 prong holder
IC insert tool
Solder core 63%, SN
Parts tube
Heat sink
8 pcs bits pack
Zipper carrying bag

- Case size: 325x195x48mm(12.8"x7.7"x1.9")
- Individual packing: Inner box & Color label shrink

▶ **500-042** 16 PC ESD Precision Tool Kit



500-042 contents
Long nose plier
Flat nose plier
Bent nose plier
Clean cut micro nipper
Micro cutting plier 125mm (4.9")
4 pcs conductive tweezer set
Wrist strap 10FT
⊕ ESD safe precision screwdriver #00
⊕ ESD safe precision screwdriver #0
⊕ ESD safe precision screwdriver #1
⊖ ESD safe precision screwdriver 2.0mm
⊖ ESD safe precision screwdriver 2.4mm
⊖ ESD safe precision screwdriver 3.0mm
Tool bag

- Case size: 340x222.5x60mm (13.4"x8.8"x2.4")
- Individual packing: Inner box & Color label shrink

▶ **902-516** 8 PC Apprentice's Tool Set

902-516 Includes 6 essential premium hand tools (plus pouch & belt) to make your job easy and efficient



902-516 contents	
8" Long Nosed Pliers	8" Diagonal Cutting Pliers
9" Heavy Duty Lineman's Pliers	AWG 20-10 Wire Stripper
1/4" x 4" Slotted Screwdriver	#2 x 4" Phillips Screwdriver
Tool Pouch	Tool Belt with Safety Lock

Individual packing: Blister card

▶ **500-038** 14 PC Electrician's Tool Pouch Kit

500-038 includes heavy duty, high quality tools, perfect for the professional or apprentice electrician



500-038 contents	
Long-Nosed Pliers w/side Cutter	Heavy Duty Lineman's Plier
9.5" Crimper Plier	Electrician's Knife
25' Tape Measure	Groove Joint Plier
Screwdrivers x 4 ⊖ 1/4"x4", 1/4"x8" ⊕ #2x4", #2x8"	AWG 16,14,12,10,8 Precision Wire Stripper
3/16" x 7.8" Cable Ties (100pcs)	Receptacle Tester- GFCI outlets
19mm x 5M Electrical Tape	Durable Black Pouch & Belt

Individual packing: Blister card

▶ **500-016** 18 PC School Tool Kit

500-016 contents	
Utility component storage box	Fine tip straight tweezer
Side Cutter 125mm (4.9")	Long nose plier 138mm (5.4")
Quick heat ceramic soldering iron 110V	
⊖ Pro-soft s/d 3.2x75mm (3.0")	⊕ Pro-soft s/d #0x75mm (3.0")
⊖ Pro-soft s/d 5.0x75mm (3.0")	⊕ Pro-soft s/d #1x75mm (3.0")
⊖ Pro-soft s/d 6.0x100mm (4.0")	⊕ Pro-soft s/d #2x100mm (4.0")
Brush	Mini soldering stand with sponge
Desoldering pump	IC extractor
7 pcs folding type hex key set (inch)	Solder core 63%, SN
Utility knife (3 blades self loading)	Zipper carrying bag

• Case size: 330x220x48mm (13.0"x8.7"x1.9")
• Individual packing: Inner box & Color label shrink



▶ **500-032** 24 PC Professional Electronic Tool Kit

500-032 contents	
Lineman's plier 165mm (6.5")	Long nose plier 160mm (6.3")
Side cutter 125mm (4.9")	Soldering iron stand with sponge
Desoldering pump	
⊖ Line color screwdriver 3.2x75mm (3.0")	⊕ Line color screwdriver #0x75mm (3.0")
⊖ Line color screwdriver 5.0x75mm (3.0")	⊕ Line color screwdriver #1x75mm (3.0")
⊖ Line color screwdriver 6.0x100mm (4.0")	⊕ Line color screwdriver #2x100mm (4.0")
⊖ Line color screwdriver nut 3/16"	⊕ Line color screwdriver nut 1/4"
6 pcs electronic screwdriver set	3-1/2 compact digital multimeter
7 pcs folding type hex key set (inch)	PVC insulated tape
PVC insulated tape	Solder core 63%, SN
Zipper carrying bag	

• Case size: 375x250x60mm (14.8"x9.8"x2.4")
• Individual packing: Inner box & Color label shrink



• NOTE : For quality reason. we reserve the right to change the above specifications without notice.

PK-2811M 15 PC 1000V Insulated Single Open End Wrench Set

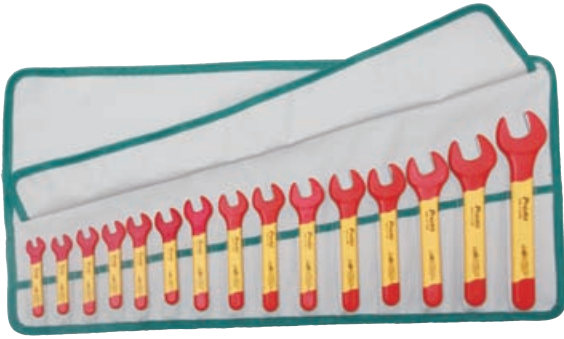

600D tool roll bag:
305x635mm(12x25")

Contents				
Material	Width across flats(mm/Inch)	Head width Max. (mm/Inch)	Head thickness Max.(mm/Inch)	OAL. ±2(mm/Inch)
50CrV	6/0.24"	23/0.91"	7.2/0.28"	90/3.55"
	7/0.28"	25/0.99"	7.2/0.28"	90/3.55"
	8/0.32"	27/1.06"	7.7/0.30"	100/3.94"
	9/0.35"	29/1.14"	7.7/0.30"	100/3.94"
	10/0.39"	31/1.22"	8.2/0.32"	110/4.33"
	11/0.43"	34/1.34"	8.7/0.34"	110/4.33"
	12/0.47"	36/1.42"	8.7/0.34"	130/5.12"
	13/0.51"	39/1.54"	10.5/0.41"	135/5.32"
	14/0.55"	40/1.58"	10.5/0.41"	145/5.71"
	15/0.59"	42/1.65"	11.5/0.45"	150/5.91"
	16/0.63"	43/1.69"	11.5/0.45"	160/6.30"
	17/0.67"	47/1.85"	12.5/0.49"	160/6.30"
	19/0.75"	53/2.09"	14.0/0.55"	175/6.90"
	22/0.87"	58/2.29"	14.0/0.55"	195/7.68"
	24/0.94"	62/2.44"	16.5/0.65"	225/8.87"

Individual packing: Color Sleeve

PK-2812M 15 PC 1000V Insulated Single Box End Wrench Set

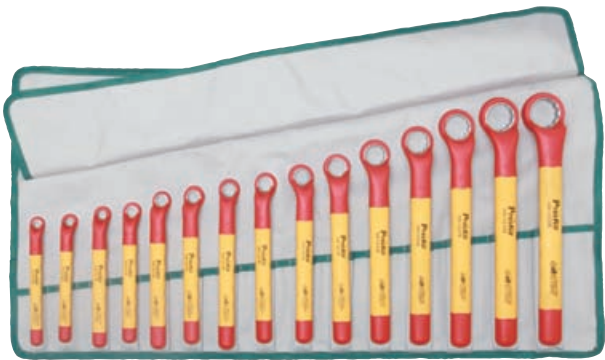

600D tool roll bag:
330x780mm(13"x30")

Contents					
Material	Width across flats (mm/Inch)	Head width Max. (mm/Inch)	Head thickness Max. (mm/Inch)	Depth of crank (mm/Inch)	OAL. ±2 (mm/Inch)
50CrV	6/0.24"	16.0/0.63"	6.8/0.27"	25/0.99"	150/5.91"
	7/0.28"	18.0/0.71"	7.0/0.28"	25/0.99"	150/5.91"
	8/0.32"	19.0/0.75"	7.4/0.29"	27/1.06"	155/6.11"
	9/0.35"	20.0/0.79"	8.3/0.33"	27/1.06"	155/6.11"
	10/0.39"	21.0/0.83"	8.8/0.35"	30/1.18"	170/6.70"
	11/0.43"	22.5/0.89"	8.9/0.35"	30/1.18"	170/6.70"
	12/0.47"	22.5/0.89"	9.8/0.39"	32/1.26"	190/7.49"
	13/0.51"	26.5/1.04"	10.0/0.39"	32/1.26"	190/7.49"
	14/0.55"	28.0/1.10"	11.0/0.43"	34/1.34"	205/8.08"
	15/0.59"	29.0/1.14"	11.1/0.44"	34/1.34"	205/8.08"
	16/0.63"	31.0/1.22"	11.5/0.45"	36/1.42"	215/8.47"
	17/0.67"	32.0/1.26"	12.3/0.48"	36/1.42"	215/8.47"
	18/0.71"	35.0/1.38"	12.7/0.50"	37/1.46"	230/9.06"
	19/0.75"	36.0/1.42"	13.2/0.52"	37/1.46"	230/9.06"
	21/0.83"	39.0/1.54"	13.9/0.55"	41/1.62"	245/9.65"
	22/0.87"	41.0/1.62"	13.9/0.55"	41/1.62"	245/9.65"
	24/0.94"	44.0/1.73"	16.0/0.63"	42/1.65"	265/10.44"
	27/1.06"	48.0/1.89"	16.4/0.65"	42/1.65"	290/11.43"
	30/1.18"	52.0/2.05"	16.8/0.66"	45/1.77"	310/12.21"
	32/1.26"	55.0/2.17"	17.5/0.69"	45/1.77"	310/12.21"

Individual packing: Color Sleeve

PK-2813M 15 PC 1000V Insulated Metric Roll Tool Kit



600D tool roll bag:
368x743 mm
(14.5"x29.2")

Ideal for power plant, HVAC, automotive, military, aircraft field applications and more.

Contents
Insulated combination plier (195mm/7.7")
Insulated side cutter(165mm/6.5")
Insulated wire stripping plier (160mm / 6.3")
Insulated long nose plier(200mm/7.9")
Insulated cable cutter 150mm (22mm ²)
Insulated single open end wrench 10mm
Insulated single open end wrench 13mm
Insulated single open end wrench 14mm
Insulated single open end wrench 17mm
Insulated single open end wrench 19mm
⊖ Insulated screwdriver(-2.5x75)
⊖ Insulated screwdriver (-4.0x100)
⊖ Insulated screwdriver (-5.5x125)
⊖ Insulated screwdriver (-6.5x150)
Insulated straight blade cable knife (50x180mm/2.0x7.1")
Tool roll bag(368x743mm/15.1x29.2")

Individual packing: Color Sleeve

▶ **902-215** 8 PC 1000V Insulated Screwdriver & Plier Set



Contents	
⊖	0.4x2.5x75mm (3")
⊖	0.5x3.0x100mm (4")
⊖	1.0x5.5x125mm (5")
⊕	PH1x80mm (3.1")
⊕	PH2x100mm (4")
	6.3" Insulated wire stripping plier
	6.3" Insulated side cutter
	6.3" Insulated long nose plier
	Zipper carrying bag
• Case size: 255x172.5x55/10.0x6.8x2.2 (mm/inch)	
• Individual packing: Inner box & Color label shrink	



▶ **902-218** 11 PC 1000V Insulated Plier & Screwdriver Set



Contents	
⊖	0.4x2.5x75mm (3")
⊖	0.8x4.0x100mm (4")
⊖	1.0x5.5x125mm (5")
⊖	1.2x6.5x150mm (6")
⊕	PH0x60mm (2.4")
⊕	PH1x80mm (3.1")
⊕	PH2x100mm (4")
	7.9" Insulated combination plier
	6.3" Insulated side cutter
	7.9" Insulated long nose plier
	6.3" Insulated long nose plier
	Zipper carrying bag
• Case size: 294x240x50/11.6x9.4x2.0 (mm/inch)	
• Individual packing: Inner box & Color label shrink	



▶ **PK-2809M** 1000V Insulated Standard Tool Kit



PK-2809M tool kit is equipped with a range of 26pcs 1000V insulated single open end wrenches, screwdrivers, pliers and cutters, T handle and 1/2" sockets in a durable tool box. Ideal for power plant, HVAC, automotive, military, aircraft field applications and more.

Contents	
PM-911	Insulated combination plier (195mm/7.7")
PM-917	Insulated side cutter(165mm/6.5")
HW-V110B	Insulated single open end wrench 10mm
HW-V111B	Insulated single open end wrench 11mm
HW-V112B	Insulated single open end wrench 12mm
HW-V113B	Insulated single open end wrench 13mm
HW-V114B	Insulated single open end wrench 14mm
HW-V117B	Insulated single open end wrench 17mm
HW-V119B	Insulated single open end wrench 19mm
SD-800-S2.5	⊖ Insulated screwdriver(-2.5x75)
SD-800-S3.0	⊖ Insulated screwdriver(-3.0x100)
SD-800-S4.0	⊖ Insulated screwdriver (-4.0x100)
SD-800-S5.5	⊖ Insulated screwdriver (-5.5x125)
SD-800-P0	⊕ Insulated screwdriver (#0x60)
SD-800-P1	⊕ Insulated screwdriver (#1x80)
SD-800-P2	⊕ Insulated screwdriver (#2x100)
SK-V752	Insulated 1/2" drive T handle (200mm/7.9")
SK-V410B	Insulated 1/2" drive socket 10mm
SK-V411B	Insulated 1/2" drive socket 11mm
SK-V412B	Insulated 1/2" drive socket 12mm
SK-V413B	Insulated 1/2" drive socket 13mm
SK-V414B	Insulated 1/2" drive socket 14mm
SK-V417B	Insulated 1/2" drive socket 17mm
SK-V419B	Insulated 1/2" drive socket 19mm
PD-V003A	Insulated straight blade cable knife (50x180mm/2.0"x7.1")
PD-V003B	Insulated hook blade cable knife (28x155mm/1.1"x6.1")
9SB-3935	Plastic tool box (390x350x90mm/15.3"x13.8"x3.5")

Individual packing: Color Sleeve

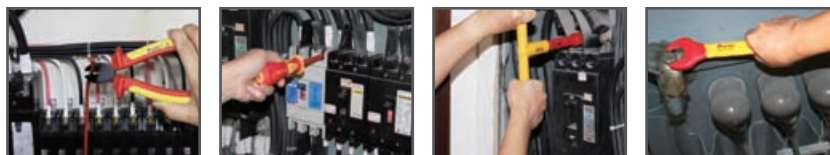

• NOTE : For quality reason. we reserve the right to change the above specifications without notice.

PK-2836M 1000V Insulated Universal Tool Kit



PK-2836M tool kit is equipped with a range of 41pcs 1000V insulated single open end wrenches, single box end wrenches, adjustable wrenches, screwdrivers, knife, pliers and cutters, T handle, 1/2" sockets and type in a durable aluminum frame tool case. Ideal for power plant, HVAC, automotive, military, aircraft field applications and more.

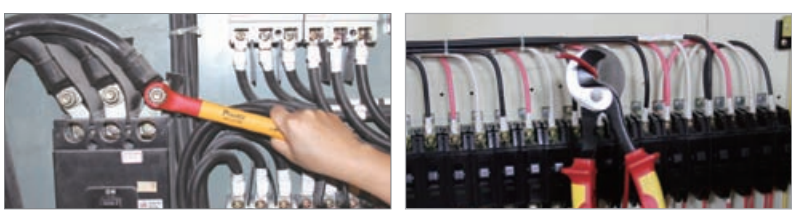

Contents	
Insulated combination plier (195mm/7.7")	
Insulated side cutter(165mm/6.5")	
Insulated wire stripping plier (160mm / 6.3")	
Insulated cable cutter 250mm (80mm ²)	
Insulated single open end wrench 10mm	
Insulated single open end wrench 13mm	
Insulated single open end wrench 14mm	
Insulated single open end wrench 17mm	
Insulated single open end wrench 19mm	
Insulated single open end wrench 22mm	
Insulated single box end wrench 10mm	
Insulated single box end wrench 13mm	
Insulated single box end wrench 14mm	
Insulated single box end wrench 17mm	
Insulated single box end wrench 19mm	
Insulated single box end wrench 22mm	
⊖ Insulated screwdriver(-2.5x75)	
⊖ Insulated screwdriver (-4.0x100)	
⊖ Insulated screwdriver (-5.5x125)	
⊖ Insulated screwdriver (-6.5x150)	
⊕ Insulated screwdriver #1(5x80)	
⊕ Insulated screwdriver #2(5x100)	
Insulated 1/2" drive T handle (200mm/7.9")	
Insulated 1/2" drive reverse flat ratchet handle (250mm/9.8")	
Insulated 1/2" drive extension bar (125mm/5")	
Insulated 1/2" drive extension bar (250mm/9.8")	
Insulated 1/2" drive socket 10mm	
Insulated 1/2" drive socket 11mm	
Insulated 1/2" drive socket 12mm	
Insulated 1/2" drive socket 13mm	
Insulated 1/2" drive socket 14mm	
Insulated 1/2" drive socket 16mm	
Insulated 1/2" drive socket 17mm	
Insulated 1/2" drive socket 18mm	
Insulated 1/2" drive socket 19mm	
Insulated 1/2" drive socket 22mm	
Insulated 1/2" drive socket 24mm	
Insulated straight blade cable knife (50x180mm/2.0x7.1")	
Insulated electricians scissors (160mm/6.3")	
Insulated tape(20mmx10M / 0.8"x32.8')	
Insulated 10" adjustable wrench	
Expert & Elegant aluminum frame tool case (486x325x159mm / 19.1x12.8x6.3")	
Top pallet for PK-2836M	
Pallet for PK-2836M	
Individual packing: Plain box+color label	

SK-22401M 24 PC 1/4" Drive Socket Tool Set

Tools meet DIN standard

INDUSTRIAL GRADE



Contents
13pcs Hand Socket 4,4.5,5,5.5,6,7,8,9,10,11,12,13,14mm
5pcs Hand Deep Socket 8,10,11,12,13mm
Extension Bar W/Wobble 2 Way 100mm
Extension Bar 55mm
Sliding T Handle 115mm
Universal Joint
Spinner Handle
72 Teeth Reverse Flat Ratchet Handle W/Quick Release
Metal Case: 245x120x35mm (9.6"x4.7"x1.4")
Individual Packing:Color Sleeve Shrink

SK-42601M 26 PC 1/2" Drive Socket Tool Set

Tools meet DIN standard

INDUSTRIAL GRADE



Contents
14pcs Hand Socket 10,12,13,14,15,16,17,18,19,22,24,27,30,32mm
4pcs Hand Deep Socket 12,14,17,19mm
2pcs Spark Plug Socket W/Magnetic 16,21mm
Extension Bar W/Quick Release 125mm
Extension Bar W/Quick Release 250mm
Sliding T Handle W/Quick Release 250mm
LED Light Adaptor
Universal Joint
72 Teeth Reversing Flat Ratchet Handle W/Quick Release
Metal Case: 445x185x50mm (18"x7.3"x2")
Individual Packing:Color Sleeve Shrink

• NOTE : For quality reason. we reserve the right to change the above specifications without notice.

PK-2061 Solar MC3 & MC4 Crimping Tool Kit

Pb This is a complete tool kit to install MC3 & MC4 solar connectors easily and accurately.



Includes 2 pcs MC4 and MC4 PLUS open-end spanner and unlocking tool help you opening the locking device, securing and tightening the cable gland.

Universal solar cable stripper comes with adjustable length stop for reliable stripping of the double layer insulated cables (2.5 - 6.0 mm²)



The Parallel action crimper features consistent and accurate performance

Heavy duty Forged Cable Cutter with high leverage Jaw and shear blade for clean cut without damage.

Prosoft screwdrivers for PV junction box installation



Contents	
Parallel Action Crimper frame	
	Die set for MC 3 solar connector (Multi-Contact) & 2.5/4/6m2 (AWG 14/12/10) solar cable.
	Die set for MC 4 solar connector (Multi-Contact) & 2.5/4/6m2 (AWG 14/12/10) solar cable.
Universal solar cable stripper, for 2.5/4/6m2 (AWG 14/12/10) solar cable	
Forged cable cutter (160mm), for copper cable: 25mm ² flexible	
2 Pcs Open-end spanner and unlocking tool (MC4 and MC4 PLUS)	
	Pro-soft screwdriver 5x75mm
	Pro-soft screwdriver #2 x100mm
Zipper carrying bag-280x197x70(mm)/11"x7.8"x2.8"	

500-017 48 PC Technician's Tool Kit



Contents	
Reverse action tweezers	
Fine tip straight tweezers	
Brush	
7 in 1 crimping tool	
IC extractor	
PLCC extractor	
Screwdriver handle	
	Pro-soft s/d 5.0x75mm (3.0")
	Pro-soft s/d #1x75mm (3.0")
	Pro-soft s/d 3/16"(inch)
Wrist strap 10FT	
Utility knife (3 blades self loading)	
LED Flash light	
7 pcs folding type hex key set (inch)	
3 prong holder	
8" Adjustable wrench	
Mini hammer set (including 6 parts)	
5 pcs needle file set	
Long nose plier 135mm (5.3")	
Diagonal cutting plier 110mm (4.3")	
Lineman's plier 210mm (8.3")	
Flat nose plier 135mm (5.3")	
Bent nose plier 130mm (5.1")	
6 pcs electronic screwdriver set	
Desoldering pump	
Quick heat ceramic soldering iron 110V	
Solder core 63%, SN	
3 pcs soldering aid tools	
Heat sink	
	Double-end blade 175mm length 4mm/T6
	Double-end blade 175mm length #1/#2
	Double-end blade 175mm length 6mm/T8
	Double-end blade 175mm length T10/T15
Extension blade 175mm (7")	
Heavy duty zipper bag	

• Case size: 435x325x90mm (17.1"x12.8"x3.5")
 • Individual packing: Color box

PK-15307EI 54 Pc Electronics Tool Kit



Contents	
Long nose plier 135mm (5.3")	
Diagonal cutting plier 110mm (4.3")	
Dual color lineman's plier 210mm (8.3")	
Dual color long nose plier 165mm (6.5")	
6" Adjustable wrench	
Dual color side cutting plier 165mm (6.5")	
5 pcs needle file set	
Ceramic Soldering Iron 110V	
3-1/2 compact digital multimeter	
Measuring tape (3M/10FT)	
Solder core 63%, SN	
7 pcs hex key set (inch)	
Wire stripper cutter	
Utility knife (3 blades self loading)	
All Purpose Snip	
Solder aid tools	
Desoldering pump	
10 pcs electronic combination wrench (inch)	
Flux bottle (2 pcs/pack)	
Blow brush (Ø62mm/Ø2.4")	
IC extractor	
Slip joint plier 154mm (6")	
⊖ Pro-soft screwdriver 3.0x75mm (3.0")	
⊕ Pro-soft screwdriver #0x75mm (3.0")	
⊖ Pro-soft screwdriver 5.0x75mm (3.0")	
⊕ Pro-soft screwdriver #1x75mm (3.0")	
⊖ Pro-soft screwdriver 6.0x100mm (4.0")	
⊕ Pro-soft screwdriver #2x100mm (4.0")	
⊕ Pro-soft screwdriver #2x250mm (10")	
⊖ Pro-soft screwdriver 6.0x40mm (1.6")	
⊕ Pro-soft screwdriver #2x40mm (1.6")	
⊖ ProSoft Precision Screwdriver 2.0x50mm (2.0")	
⊖ ProSoft Precision Screwdriver 2.4x75mm (3.0")	
⊖ ProSoft Precision Screwdriver 3.0x100mm (4.0")	
⊕ ProSoft Precision Screwdriver #00x50mm (2.0")	
⊕ ProSoft Precision Screwdriver #0x75mm (3.0")	
⊕ ProSoft Precision Screwdriver #1x150mm (6.0")	
Soldering tip cleaner	
Fine tip straight tweezer	
Utility component storage box	
Hobby vise	
2 pcs pallets	
Aluminum frame tool case	

- Case size (O.D): 458x330x150mm (18"x13"x5.9")
- Individual packing: Color box

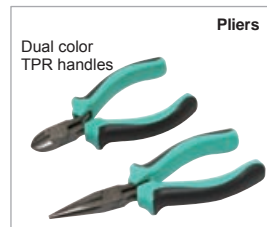
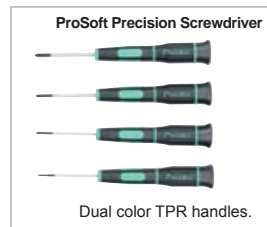
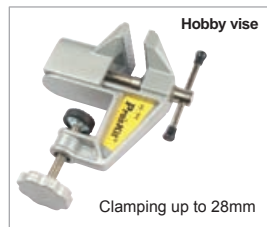

• NOTE : For quality reason. we reserve the right to change the above specifications without notice.

▶ 1PK-1900NA Pro's Electronic Tool Kit



Contents
Utility component storage box
Long nose plier 135mm (5.3")
Diagonal cutting plier 110mm (4.3")
Flat nose plier 135mm (5.3")
Bent nose plier 130mm (5.1")
Dual Color Lineman's Plier
Reverse action tweezer
Super drill set w/adaptor 110V
3 pcs soldering aid tools
Soldering iron stand with sponge
6" Adjustable wrench
Ceramic Soldering Iron 110V
Screwdriver handle
⊖ Pro-soft s/d 3/16" (inch)
⊖ Pro-soft s/d 1/4" (inch)
⊖ Pro-soft s/d 3.2x75mm (3.0")
⊕ Pro-soft s/d #0x75mm (3.0")
⊖ Pro-soft s/d 5.0x75mm (3.0")
⊕ Pro-soft s/d #1x75mm (3.0")
⊖ Pro-soft s/d 6.0x57mm (2.2")
⊕ Pro-soft s/d #2x57mm (2.2")
⊕ Pro-soft s/d #2x157mm (6.2")
⊕ Pro-soft s/d #1x150mm (6.0")
⊖ Pro-soft screwdriver 6.0x40mm (1.6")
⊕ Pro-soft screwdriver #2x40mm (1.6")
Brush
Crimping tool (inch)
Desoldering pump
Precision s/d set 6 pcs
5 pcs needle file set
Mini-vacuum cleaner
Cleaning fluid, head (60cc)
Cleaning fluid, head (18cc)
3-1/2 compact digital multimeter
Testing screwdriver
IC extractor
LED Flash light
7 pcs folding type hex key set (inch)
3 prong holder
PVC insulated tape
6" Stainless scissors
Solder core 63%, SN
Bit T10x30mm (1.2")
Bit T15x30mm (1.2")
Wrist strap 10FT
Utility knife (3 blades self loading)
10 pcs electronic combination wrench (inch)
Hobby vise (Jaw opening 40mm/1.6", width 60mm/2.4")
2pcs pallets
Aluminum frame tool case

- Case size (O.D): 458x330x150mm (18"x13"x5.9")
- Individual packing: Color box



▶ 1PK-1700NA 57 PC Electronics Master Kit



Contents
Utility component storage box
Long nose plier 135mm (5.3")
Diagonal cutting plier 110mm (4.3")
Dual Color Lineman's Plier
Bent nose plier 130mm (5.1")
Side cutting plier 150mm (5.9")
Dual color long nose plier
Reverse action tweezers
3 pcs soldering aid tools
Soldering iron stand with sponge
Adjustable wrench 6"
Ceramic Soldering Iron 110V
⊕ Pro-soft s/d 3/16"(inch)
⊖ Pro-soft s/d 1/4"(inch)
⊕ Pro-soft s/d 3.2x75mm (3.0")
⊖ Pro-soft s/d #0x75mm (3.0")
⊕ Pro-soft s/d 5.0x75mm (3.0")
⊖ Pro-soft s/d #1x75mm (3.0")
⊕ Pro-soft s/d 6.0x100mm (4.0")
⊖ Pro-soft s/d #2x100mm (4.0")
⊕ Pro-soft screwdriver 6.0x40mm (1.6")
⊖ Pro-soft screwdriver #2x40mm (1.6")
Desoldering braid
Brush
6 pcs electronic screwdriver set
Crimping tool (inch)
Desoldering pump
5 pcs needle file set
Testing screwdriver
Alignment tool 2.0mmx200mm (2.0mmx7.9")
IC extractor
Oil can
LED Flash light
7 pcs folding type hex key set (inch)
3 prong holder
6 pcs open-end wrench set
Heavy duty curved-claw hammer
PVC insulated tape
Stainless scissors 6"
Solder core 63%, SN
Parts tube
Heat sink
Utility knife (3 blades self loading)
Measuring tape 3M/10FT
Inspection mirror
Slip-channel pump pliers 254mm (10")
2 pcs pallets
Carrying tool case

- Case size (O.D): 450x325x132mm (17.7"x12.8"x5.2")
- Individual packing: Color box

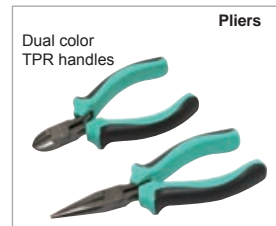

• NOTE : For quality reason. we reserve the right to change the above specifications without notice.

▶ 1PK-1990A Jumbo Tool Kit



Contents
Utility computer storage box
Flat nose plier 135mm (5.3")
Bent nose plier 130mm (5.1")
Lineman's plier 210mm (8.3")
Side cutting plier 165mm (6.5")
Fine tip straight tweezers
Spring hook
3 pcs soldering aid tools
Desoldering pump
Super drill set w/adaptor 110V or 220V
3 pcs anti-static alignment tool kit
Diagonal cutting nipper
Long nose plier
Long nose plier 165mm (6.5")
Adjustable wrench 6"
Ceramic Soldering Iron 110V
Straight forceps 6"
● Pro-soft s/d 3/16"(inch)
● Pro-soft s/d 1/4"(inch)
⊖ Pro-soft s/d 3.2x75mm (3.0")
⊕ Pro-soft s/d #0x75mm (3.0")
⊖ Pro-soft s/d 5.0x75mm (3.0")
⊕ Pro-soft s/d #1x75mm (3.0")
⊖ Pro-soft s/d 6.0x100mm (4.0")
⊕ Pro-soft s/d #2x100mm (4.0")
⊕ Pro-soft s/d #2x157mm (6.2")
Desoldering wick
Brush
6 pcs electronic screwdriver set
40 pcs socket & screwdriver set
Precision wire stripper
Crimping tool (inch) or (metric)
5 pcs needle file set
IC extractor
Mini flash light
7 pcs folding type hex key set (inch)
3 prong holder
Heavy duty curved-claw hammer
PVC insulated tape
Solder core 63%, SN
Heat sink
Wrist strap 10FT
Measuring tape 3M/10FT
10 pcs electronic combination wrench (inch)
Inspection mirror
Slip joint plier 154mm (6.1")
Pallet for 1PK-1990
Top pallet for 1PK-1990
Aluminum frame tool case

Ceramic Soldering Iron

Ceramic heating element, thermal recovery fast.

Socket & Screwdriver Set

40pcs high quality 1/2" socket set

Pliers

Made of S45c carbon steel with nickel iron plated.

Super Drill Set



Contents	
Utility component storage box	
Reverse action tweezers	
3 pcs anti-static alignment tool kit	
Micro cutting plier	
Long nose plier	
Diagonal cutting nipper	
Long nose plier	
Long nose plier 165mm (6.5")	
Cabling splicing knife	
4" Adjustable wrench	
8" Adjustable wrench	
Solder aid tool	
Quick heat ceramic soldering iron 110V	
DMM with mechanical mistake prevention operation	
⊖ Line color screwdriver 3.2x75mm (3.0")	
⊕ Line color screwdriver #0x75mm (3.0")	
⊕ Line color screwdriver 5.0x75mm (3.0")	
⊕ Line color screwdriver #1x75mm (3.0")	
⊖ Line color screwdriver 3.2x100mm (4.0")	
⊖ Line color screwdriver 6.0x100mm (4.0")	
⊕ Line color screwdriver #2x100mm (4.0")	
⊖ Line color screwdriver 3.2x200mm (8.0")	
⊖ Line color screwdriver 6.0x38mm (1.5")	
⊕ Line color screwdriver #2x38mm (1.5")	
⊖ Line color screwdriver 8.0x150mm (6.0")	
Brush	
6 pcs electronic screwdriver set	
Snap ring plier set	
Precision wire stripper	
Multi-purpose crimping tool (inch)	
23 pcs 1/4" socket set	
Oil can	
Mini flash light	
7 pcs folding type hex key set (inch)	
Center punch tool	
Feeler gauge	
Ball peen hammer with fiberglass handle	
Spring hook	
Spring hook	
6" Steel ruler	
3 pcs soldering aid tools	
Super torque ratchet handle	
4 pcs hex driver blades: 1/16", 5/64", 3/32", 1/8"	
7 pcs nut driver blades: 1/4", 3/8", 3/16", 5/16", 7/16", 11/32", 1/2"	
⊖ Double ended screwdriver 3mm/#0	
⊕	
Electrician's scissors	
10 pcs electronic combination wrench (inch)	
Inspection mirror	
Slip-channel pump pliers 254mm (10")	
ABS tool carrying case with second pallet	

• Case size (O.D): 463x331x171mm (18.2"x13.0"x6.7")
 • Individual packing: Color box



• NOTE : For quality reason. we reserve the right to change the above specifications without notice.

▶ **PK-15308EM** Field and Maintenance Service Kit



Contents
3-3/4 autorange digital multimeter
23 pcs 1/4" driver socket set
Heavy duty curved-claw hammer W/fiberglass handle
8" Adjustable wrench
IC extractor
Hobby vise
Slip-channel pump pliers 254mm (10")
⊖ ProSoft Precision Screwdriver 2.0x50mm (2.0")
⊖ ProSoft Precision Screwdriver 2.4x75mm (3.0")
⊖ ProSoft Precision Screwdriver 3.0x100mm (4.0")
⊕ ProSoft Precision Screwdriver #00x50mm (2.0")
⊕ ProSoft Precision Screwdriver #0x75mm (3.0")
⊕ ProSoft Precision Screwdriver #1x150mm (6.0")
Wire Stripper Cutter
⊕ Pro-Soft Screwdriver 5.0x75mm (3.0")
⊕ Pro-Soft Screwdriver #1x75mm (3.0")
⊖ Pro-Soft Screwdriver 5.0X100mm (4.0")
⊕ Pro-Soft Screwdriver #1x100mm (4.0")
⊕ Pro-Soft Screwdriver #2X100mm (4.0")
⊖ Pro-Soft Screwdriver 6.0x40mm (1.6")
⊕ Pro-Soft Screwdriver #2x250mm (9.8")
⊕ Pro-soft screwdriver #2x40mm (1.6")
Fine tip straight tweezer
Utility component storage box
Long nose plier 135mm (5.3")
Diagonal cutting plier 110mm (4.3")
Lineman's plier 165mm (6.5")
Dual color cutting plier
Dual color long nose plier
9 pcs ball point long arm hex key set
10 pcs electronic combination wrench (inch)
5 pcs needle file set
Ceramic Soldering Iron 110V
Desoldering wick
Solder core 63%, SN
PVC insulated tape
Utility knife (3 blades self loading)
Measuring tape 3M/10FT
All Purpose Snip
Desoldering pump
Flux bottle (2 pcs/pack)
Blow brush (Ø62mm/Ø2.4")
Telescopic magnetic pick up tool
Inspection mirror
1pc Pallet
Heavy-duty ABS cases with wheels and telescoping handle

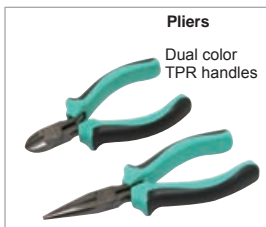
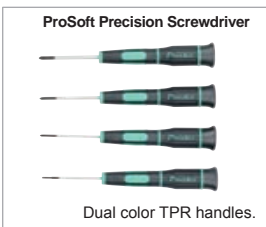
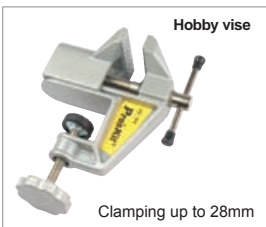

• Case size (O.D): 465x335x190mm (18.3"x13.2"x7.5")
 • Individual packing: Color box
 • Not designed to be checked as airline baggage.

PK-5011 CATV / CCTV Basic Tool Kit



This is a complete tool bundle along with F connectors to install or remove existing or additional cable TV, satellite outlets or cable modems. It includes adjustable waterproof compression tool, coaxial cable stripper/cutter and 4pcs F connectors to make your work smart & easy.



Contents	
Adjustable Compression Tool	
Coaxial Cable Stripper/Cutter	
4pcs F connectors for RG6 quad coaxial	
Carry case (160x120x45 mm / 6.3x4.7x1.8 inch)	
Individual packing	Blister card

PK-2006 LAN Basic Tool Kit



This is a complete tool bundle to make RJ45 or RJ11/RJ12 patch cords for phone and computer. It includes 6P/8P parallel action modular crimper and stripper to make your job well done.



Contents	
Modular crimping tool	
Wire stripping tool	
Carry case (160x120x45 mm / 6.3x4.7x1.8 inch)	
Individual packing	Blister card

500-001 Coaxial Crimping Tool Kit



Contents	
Crimping tool	
Rotary coaxial cable stripper	
Round cable cutter	
Screwdriver #1x125	
DIES:	
.255", .213", .187", .068" (Hex)	
.319", .256", .213", .068" (Hex)	
.043" (SQ), .100", .213", .068", .137", .255" (Hex)	
.042" (SQ), .078", .151", .068", .128", .178" (Hex)	
.10", .128", .429" (Hex)	
Carrying case	

- Case size: 305x210x58mm (12.0"x8.3"x2.3")
- Individual packing: Color label shrink

• NOTE : For quality reason. we reserve the right to change the above specifications without notice.

▶ 500-031 Professional Twisted Pair Installer Kit



Contents
RJ-45 die set
RJ-11 die set
RJ-11 DEC die set
AMP RJ-45 die set
RJ-22 die set
Supercrimp crimp tool frame
Punch down tool with 110/66 blades
Multi-function wire strippers
6-position 4 contact flat stranded (50 pcs/bag)
8-position 8 contact round stranded (25 pcs/bag)
Blowing case

- Case size: 340x250x65mm (13.4"x9.8"x2.6")
- Individual packing: Color label shrink

▶ 500-021 Category 5e/6 Termination Kit



Contents
Multi-network cable tester
Punch down tool with 110/66 blades
Modular crimping tool
UTP/STP cable stripper
4-position 4 contact flat stranded (50 pcs/bag)
8-position 8 contact round stranded (25 pcs/bag)
RJ-45 protection cap. (20 pcs/bag)
Zipper carrying bag

- Case size: 280x197x70mm (11.0"x7.8"x2.8")
- Individual packing: Inner box & Color label shrink

▶ 500-006 Network Maintenance Kit



Contents
Diagonal cutting nipper
Long nose plier
6" Adjustable wrench
Quick heat ceramic soldering iron 110V
6" Straight forceps
For crimping coax connectors
Rotary coaxial cable stripper
● Pro-soft s/d 3/16"(inch)
● Pro-soft s/d 1/4"(inch)
● Pro-soft s/d T10
● Pro-soft s/d T15
● Pro-soft s/d T20
⊖ Pro-soft s/d 3.2x75mm (3.0")
⊕ Pro-soft s/d #0x75mm (3.0")
⊖ Pro-soft s/d 5.0x75mm (3.0")
⊕ Pro-soft s/d #1x75mm (3.0")
⊖ Pro-soft s/d 6.0x100mm (4.0")
⊕ Pro-soft s/d #2x100mm (4.0")
Precision wire stripper
Desoldering pump
Pro-crimper modular tool
IC extractor
Mini flash light
7 pcs folding type hex key set (inch)
Inspection mirror
Zipper carrying bag

- Case size: 375x250x60mm (14.8"x9.8"x2.4")
- Individual packing: Inner box & Color label shrink

▶ 902-241 Cable Service Kit

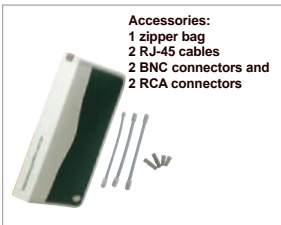

Contents
All-in-one toner & probe kit
Pro-crimper modular tool
Punch down tool with 110/88 and 66 double end blade
Universal stripping tool (UTP/STP, RG-59/6/7/11)
6-in-1 magnetic quick change screwdriver
All purpose snip
Carring zipper case

- Bag size: 333x210x50mm(O.D.)
- Individual packing: Inner box & Color label shrink



Copper cabling detecting



10 Base-T or 10/100 Base-T datacom networks



Locates and isolates cables quickly and easily

▶ 500-018 Master Network Installation Kit

Contents
RJ45 die set
RJ11 die set
RG58, RG59/62, BNC/TNC die set
Supercrimp crimp tool frame
Multi-network cable tester
Round cable cutter
Rotary coaxial stripper
Precision wire stripper
Punch down tool with 110/66 blades
Mini flash light
7 pcs folding type hex key set (inch)
Extension blade 7" (175mm)
Nut blade: 1/4", 3/8", 3/16", 7/16", 11/32", 5/16" (inch)
Driver blade T6
Driver blade T7
Driver blade T8
Driver blade T9
Super torque ratchet handle
8 pcs screwdriver blades: ⊕ #0, #1, #2 ⊖ 3, 5, 6mm ⊕ T10, T15
Inspection mirror
Zipper carrying bag

- Case size: 340x222.5x60mm (13.4"x8.8"x2.4")
- Individual packing: Inner box & Color label shrink

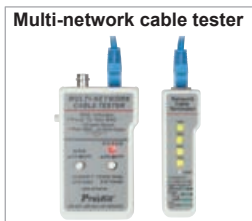

Multi-network cable tester for auto scanning the wires continuity, mis-wiring and polarization of network cables.

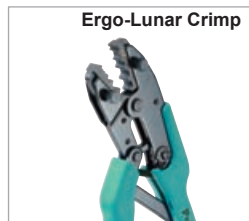

Pro-Crimper Ratcheting Crimper features 40-50% force saving.

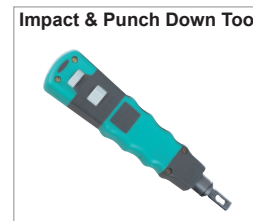

Ergonomic punch down tool increased HI/LOW forces.

▶ PK-12012H Telecom Installation Kit



Butt Set



Features high impedance monitor for data safe operation, allowing use in toughest environment

Pliers

Dual color TPR handles



Contents
Dual color long nose plier 136mm (5.4")
Dual color diagonal cutting plier 125mm (4.9")
Professional modular plug tool crimps strips & cuts
Punch down tool 110 blade and 66 blade
Multi-modular cable tester
Butt set
⊖ pro-soft screwdriver 5x75mm (3.0")
⊖ pro-soft screwdriver 6x100mm (4.0")
⊕ pro-soft screwdriver #2x100mm (4.0")
⊕ pro-soft screwdriver #2x40mm (1.6")
Soft side tool pouch

- Case size: 305x235x95mm (12"x9.3"x3.7")
- Individual packing: Color box

▶ 500-043 Communication Maintenance Kit



Contents
Reverse action tweezer
Spring hook
3 pcs anti-static alignment tool kit
Micro cutting plier
Diagonal cutting nipper
Long nose plier
Long nose plier 165mm (6.5")
6" Adjustable wrench
Probe-pic spudger
5" Straight forceps
Tone probe kit
Replacement blade-110
6 pcs electronic screwdriver set
Precision wire stripper
Insertion/extraction tool
Mini flash light
7 pcs folding type hex key set (inch)
Impact & punch down tool w/o blade
6" Steel ruler
Extension blade 7" (175mm)
Super torque ratchet handle
8 pcs screwdriver blades:
⊕ #0, #1, #2 ⊖ 3, 5, 6mm ⚙ T10, T15
7 pcs nut driver blades:
⚙ 1/4", 3/8", 3/16", 5/16", 7/16", 11/32", 1/2" (inch)
Double ended screwdriver ⊖ 3mm/⊕ #0
Wrist strap 10FT
Measuring tape 3M/10FT
Electrician's scissors
Inspection mirror
Butt set
Dual telephone line tester
Electrician's knife
Slip-channel pump pliers 204mm (8.03")
2 pallets
Deluxe carrying bag

- Case size: 435x325x90mm (17.1"x12.8"x3.5")
- Individual packing: Plain box + Color label

Butt Set



Features high impedance monitor for data safe operation, allowing use in toughest environment

Tone & Probe Kit



Locating telephone/twisted pair wire and all voice and data cables.

Precision Wire Stripper



Precision wire stripping and gripping.

PK-4302AI PC Networking Tool Kit



Contents
Dual Color Side Cutting Plier 165mm (6.5")
Dual Color Long Nose Plier 165mm (6.5")
Soldering Iron 30W (110V)
Die Set for RJ45/8P8C
Die Set for RG 58,59,62,6
Die Set for RG 59, 6, F Type
Die Set for Fiber optic connector
Supercrimp Crimp Tool Frame
Wire Stripper Tool
Pen Solder 63%
Pro-Soft Screwdriver 3/16"(inch)
Pro-Soft Screwdriver 1/4"(inch)
Pro-Soft Screwdriver 3.0x75mm (3.0x3.0")
Pro-Soft Screwdriver #0x75mm (#0x3.0")
Pro-Soft Screwdriver 5.0x100mm (5.0x4.0")
Pro-Soft Screwdriver #1x100mm (#1x4.0")
Pouch Down Tool with 110 Blades
Ball Peen Hammer
Wire Stripping Tool for 0.5, 1.2,1.6,2.0mm
Utility Knife (3 Blades Self Loading)
Measuring Tape (3M/10FT)
Desoldering Pump
7 pcs Folding Type Hex Key Set (inch)
3 1/2 Compact Digital Multimeter
Multi-Modular Cable Tester
Utility Component Storage Box
All Purpose Snip
Aluminum Frame Tool Case W/1 Pallet

- Case size: 458x330x150mm (18.0"x13.0"x5.9")
- Individual packing: Color box

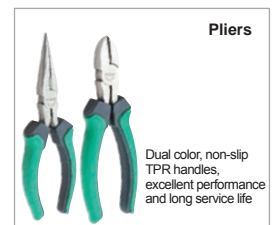

• NOTE : For quality reason. we reserve the right to change the above specifications without notice.

▶ 500-020 Communication Maintenance Kit



Contents
Network cable tester (patch cord not included)
Side cutter 125mm (4.92")
Long nose plier 138mm (5.43")
RJ-45 die set
RJ-11 die set
RG-58, RG-59/62, BNC/TNC die set
RJ-22 die set
RG-58, RG-59/62 AU BNC/TNC die set
Supercrimp crimp tool frame
Desoldering pump
Quick heat ceramic soldering iron 110W
6" Curved forceps
Multi-network cable tester
Round cable cutter
Rotary coaxial stripper
Desoldering braid
Precision wire stripper
Punch down tool with 110/66 blades
Mini flash light
7 pcs folding type hex key set (inch)
Blowing brush
Extension blade 7" (175mm)
● Nut blade: 1/4", 3/8", 3/16", 7/16", 11/32", 5/16"
Super torque ratchet handle
8 pcs screwdriver blades: ⊕ #0, #1, #2 ⊖ 3, 5, 6mm ⊕ T10, T15
● Driver blade T6
● Driver blade T7
● Driver blade T8
● Driver blade T9
Wrist strap 10FT
Inspection mirror
3- 3/4 autorange digital multimeter
2pcs pallets
ABS tool carrying case w/1 pallet

• Case size: 435x310x145mm (17.1"x12.2"x5.7")
• Individual packing: Color box

3 3/4 auto range Digital multimeter

Auto range/
Frequency/
Capacitance/
Temperature

Precision Wire Stripper

Precision wire stripping and gripping.

Ceramic Soldering Iron

Ceramic heating element, thermal recovery fast.

Ergo-Lunar Crimp Frame Only

Pro-Crimper Ratcheting Crimper features 40-50% force saving.

Multi-network cable tester

Auto scanning the wires continuity, miss-wiring and polarization of network cables.

Impact & Punch Down Tool

Ergonomic punch down tool increased HI/LOW forces.



Contents
Long nose plier 135mm (5.3")
Diagonal cutting plier 115mm (4.5")
Dual color side cutting plier 165mm (6.5")
Dual color long nose plier 165mm (6.5")
Adjustable wrench 6"
3 3/4 Autorange digital multimeter
Tone probe kit
7 pcs hex key set (inch) or (metric)
Punch down tool 110 blade
All Purpose Snip
Butt set
In-line modular adapters 4/6/8 pin 3 in 1
Electrician's knife
⊕ Pro-soft screwdriver 3.0 x75mm (3.0")
⊕ Pro-soft screwdriver #0 x75mm (3.0")
⊕ Pro-soft screwdriver 6.0 x100mm (4.0")
⊕ Pro-soft screwdriver #2 x100mm (4.0")
⊕ Pro-soft screwdriver 5.0 x100mm (4.0")
⊕ Pro-soft screwdriver #1 x100mm (4.0")
⊕ Pro-soft screwdriver 3/16" (inch) or 5mm (metric)
⊕ Pro-soft screwdriver 1/4" (inch) or 6mm (metric)
Deluxe aluminum frame tool case

- Case size(O.D): 440x340x165mm (17.3"x13.4"x6.5")
- Individual packing: Plain box + Color label

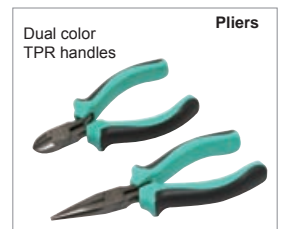
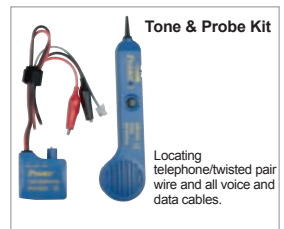

▶ 902-242 Deluxe Telecom Installation Kit



Contents
All purpose snip
Double end socket can wrench
8 pcs folding hex key set
Electrician's knife
6" Long nose plier black oxide finish
Dual color diagonal cutting plier (110mm/4.33")
Micro cutting plier
6" Adjustable wrench
Probe-pic spudder
Electrician's scissors
⊖ Pro-soft screwdriver 6.0x100mm (4.0")
⊕ Pro-soft screwdriver #2x100mm (4.0")
⊖ Pro-soft screwdriver 5.0x100mm (4.0")
⊕ Pro-soft screwdriver #1x100mm (4.0")
Double-end screwdriver
Precision hand drill
23 pcs 1/4" driver socket set
All-in-one toner & probe kit
In-line modular adapters 4/6/8 pin 3 in 1
Punch down tool with 110/66 blades
Heavy duty curved-claw hammer W/Fiberglass handle
Fish tape (50FT)
Velcro cable tie-5" assortment (15 pcs/pack)
10 pcs electronic combination wrench (Inch)
Utility component storage box
Pro-crimper (frame only)
Die set for 902-085 8P8C/RJ45 plug & cable O/D around 5.2ø
Die set for 902-085 RG 58, 59, 62, 174
Die set for 902-085 CATV F connectors RG 59, 6
Hi-reliability tape measure 3M/10Ft
6" straight forceps
2 pallets
Aluminum frame tool case with second pallet

- Case size: 461x331x156mm (18.2"x13"x6.1")
- Individual packing: Color box

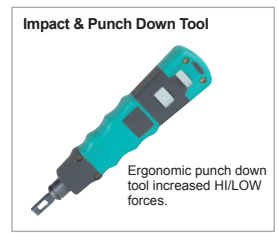



PK-4023EI

Master Telecom Installation and Service Kit



Contents
Desoldering wick with 2.0mm
Blowing brush
Rotary Coaxial Stripper
2 pallets
7" Extension blade (175mm)
Driver blade T6
Driver blade T7
Driver blade T8
Driver blade T9
8 pcs screwdriver blades
⊕ #0, #1, #2 ⊖ 3, 5, 6mm ⊕ T10, T15
Wrist strap 10FT
● Nut blade: 1/4", 3/8", 3/16", 7/16", 11/32", 5/16"(inch)
Super torque ratchet handle
5" cutting pliers
5.5" long nose pliers
8" lineman's pliers (215mm/8.46") black oxide finish
Professional 3 3/4 auto-ranging digital multimeter
All purpose snip
6" Adjustable wrench
8.7" fiber optic crimping tool
8 pcs folding hex key set
10" Adjustable wrenches
Double end socket can wrench
Utility knife(3 blades self loading)
Punch down tool with 110/66 blades
4P/6P/8P Telecom crimping tool
Testing screwdriver
Utility component storage box
Soldering iron 110V
Precision wire stripper (AWG22/20/18/16/14/12/10)
All-in-one toner & probe kit
Data diver
Tool case W/1 pallet

- Case size (O.D): 463x331x171mm (18.2"x13.0"x6.7")
- Individual packing: Color box

3 3/4 auto range Digital multimeter



Auto range/
Frequency/
Capacitance/
Temperature

All-In-One Toner & Probe Kit



VDV Tester(Voice/Data/Video)

Fiber Optic Crimping Tool



For crimping ST, SC & FC fiber optic connectors, RG58, RG174 & Belden 8218

Data Diver



Features LCD display, Talk/monitor function, line polarity and power saving

• NOTE : For quality reason. we reserve the right to change the above specifications without notice.

Cat.#	Page	Cat.#	Page	Cat.#	Page	Cat.#	Page	Cat.#	Page
1		200-063	45	300-089	61	300-195	55	700-010	81
100-002	66	200-064	77	300-090	61	4		700-011	81
100-003	35	200-065	78	300-091	64	400-001	12	700-012	81
100-004	35	200-067	33	300-092	63	400-004	12	700-014	80
100-006	33	200-068	45	300-095	56	400-011	9	700-015	81
100-007	30	200-069	45	300-096	54	400-026	10	700-016	80
100-008	61	200-070	73	300-097	57	400-028	7	700-017	81
100-011	32	200-071	29	300-101	56	400-029	25	700-018	80
100-012	33	200-072	73	300-102	56	400-030	25	700-020	81
100-013	32	200-078	74	300-103	57	400-042	6	700-021	81
100-014	33	200-078B	74	300-104	56	400-044	155	700-022	81
100-015	33	200-080	29	300-105	57	5		700-023	81
100-017	33	200-081	77	300-106	68	500-001	203	700-025	80
100-021	42	200-082	30	300-107	68	500-003	190	700-025-25	80
100-022	44	200-083	30	300-108	56	500-006	204	700-026	81
100-025	33	200-084	78	300-109	55	500-016	191	700-027	81
100-033	42	200-085	73	300-112	55	500-017	196	700-029	80
100-035	50	200-087	35	300-115	56	500-018	205	700-RA50	167
100-035	151	200-088	29	300-116	55	500-020	208	701	
100-039	43	200-090	77	300-117	55	500-021	204	701-001	164
100-040	35	200-091	74	300-118	56	500-023	152	701-002	164
100-042	35	200-092	31	300-119	55	500-024	102	701-003	164
100-044	35	3		300-120	56	500-025	189	701-004	164
100-046	31	300-001	57	300-126	NP-08	500-030	201	701-005	164
100-049	50	300-001	164	300-127	NP-08	500-031	204	701-006	164
1PK		300-002	56	300-130	56	500-032	191	701-007	165
1PK-125T	128	300-003	55	300-131	56	500-036	144	701-007-100	165
1PK-1700NA	199	300-004	60	300-132	56	500-037	66	701-008	165
1PK-1900NA	198	300-004B	60,61	300-133	56	500-038	191	701-008-100	165
1PK-1990A	200	300-005	56	300-134	57	500-041	102	701-009	165
1PK-3003D30	55	300-007	55	300-141	56	500-042	190	701-010	165
1PK-3003D31	55	300-009	57	300-142	56	500-043	206	701-010-100	165
1PK-3003D32	55	300-010	57	300-143	56	500-047	190	701-011	165
1PK-3003D33	55	300-011	64	300-144	57, 164	5CP-16A	81	701-011-100	165
1PK-3003D34	55	300-012	NP-08	300-145	57	5CP-376E-B	61	701-012	165
1PK-3003FD27	56	300-015	65	300-146	56	5DP-366D-T	89	701-013	165
1PK-3179	157	300-016	65	300-147	56	5DP-366J-T	89	701-013-100	165
1PK-9402	107	300-018	61	300-149	63	5DP-366P-T	89	701-014	165
2		300-019	55	300-151	44	5FB-1688-BLADE	150	701-014-100	165
200-002	29	300-021	56	300-157	55	5FB-C010-RPM	150	701-015	165
200-003	74	300-022	55	300-158	55	5MT-7601-LC	148	701-016	165
200-003B	74	300-023	55	300-159	55	5MT-8006-CROC	7	701-016-100	165
200-004	78	300-024	56	300-160	57	5PK-376K-BLADE	59	701-017	165
200-005	77	300-027	NP-08	300-161	55	5SI-125T-B	88	701-018	165
200-006	46	300-028	61	300-162	55	5SI-125T-D	88	701-019	165
200-007	73	300-035	64	300-163	55	5SI-125T-SB	88	701-019-100	165
200-007W	73	300-038	55	300-164	56	5SI-216N-0.8D	87	701-020	165
200-009	75	300-039	56, 58	300-165	57	5SI-216N-1.2D	87	701-021	165
200-013	45	300-041	55	300-166	57	5SI-216N-1.6D	87	701-022	165
200-014	74	300-042	NP-08	300-167	56	5SI-216N-1C	87	701-022-100	165
200-015	44	300-045	55	300-168	55	5SI-216N-2.4D	87	701-023	165
200-016	76	300-047	56	300-169	56	5SI-216N-2C	87	701-023-100	165
200-034	46	300-048	55	300-170	57	5SI-216N-3.2D	87	701-024	165
200-035	46	300-049	55	300-171	57	5SI-216N-3C	87	701-024-100	165
200-036	75	300-050	56	300-172	56	5SI-216N-4C	87	701-025	165
200-037	35	300-053	NP-08	300-173	55	5SI-216N-B	87	701-025-100	165
200-038	42	300-054	54	300-174	56	5SI-216N-B1.0	87	701-026	165
200-039	45	300-055	68	300-175	57	5SI-216N-BC	87	701-026-100	165
200-040	30	300-056	53, 54	300-176	57	5SI-216N-I	87	701-027	165
200-041	30	300-058	56	300-177	56	5SI-216N-K	87	701-027-100	165
200-042	73	300-063	60	300-178	55	5SS-989NE-H	83	701-028	165
200-043	46	300-064	59	300-179	55	5SS-989NE-H	83	701-028-100	165
200-045	45	300-070	56	300-180	55	5SS-969NE-HG	84	701-029	165
200-046	44	300-071	56	300-181	55	6		701-029-100	165
200-047	151, 72	300-072	56	300-182	55	600-006	142	701-030	165
200-048	75	300-073	56	300-183	55	6HP-9060	25	701-030-100	165
200-050	78	300-074	62	300-184	55	6HP-9100	25	701-031	165
200-051	78	300-075	64	300-185	55	6HP-9150	25	701-031-100	165
200-053	61	300-077	57, 164	300-186	55	6HP-9250	25	701-032	165
200-056	32	300-077D	57	300-187	55	6S-2	92	701-032-100	165
200-057	32	300-079	65, 164	300-188	55	700		701-033	165
200-058	32	300-086	57	300-189	55	700-007	81	701-033-100	165
200-059	32	300-087	57	300-193	55	700-008	81	701-034	165
200-060	33	300-088	61	300-194	55	700-009	81	701-034-100	165

Cat.#	Page	Cat.#	Page	Cat.#	Page	Cat.#	Page	Cat.#	Page
701-035	165	701-104	165	705-002-BU-50	163	800-015	106	800-115	97
701-035-100	165	701-104-100	165	705-003-BK	163	800-016	106	800-116	97
701-036	165	701-111	165	705-003-BK-10	163	800-017	106	800-117	97
701-036-100	165	701-111-100	165	705-003-BK-20	163	800-018	106	800-118	97
701-037	165	701-112	165	705-003-BK-50	163	800-019	106	800-119	97
701-038	165	701-113	165	705-004-BK	163	800-020	106	800-120	97
701-039	165	701-113-100	165	705-004-BK-10	163	800-021	106	800-121	97
701-040	165	701-114	165	705-004-BK-20	163	800-022	106	800-122	97
701-041	165	701-115	164	705-004-BK-50	163	800-023	106	800-123	106
701-042	165	701-116	165	705-004-BU	163	800-024	106	800-124	117
701-043	165	701-117	165	705-004-BU-10	163	800-025	106	800-129	99
701-044	165	701-117-100	165	705-004-BU-20	163	800-026	106	800-130	97
701-045	165	701-120	165	705-004-BU-50	163	800-027	106	800-148	111
701-046	165	701-121	165	705-004-GN	163	800-028	110	800-149	104
701-047	164	701-122	165	705-004-GN-10	163	800-029	110	800-150	104
701-048	164	701-122-100	165	705-004-GN-20	163	800-030	106	800-152	107
701-049	164	701-125	164	705-004-GN-50	163	800-032	106	800-153	107
701-050	164	701-126	164	705-004-RD	163	800-033	106	800-154	107
701-051	164	701-127	164	705-004-RD-10	163	800-034	106	8PK	
701-052	164	701-128	164	705-004-RD-20	163	800-035	106	8PK-2066	107
701-053	164	701-129	164	705-004-RD-50	163	800-036	106	8PK-378A	NP-06
701-054	164	701-130	164	705-004-WH	163	800-037	106	8PK-378B	NP-06
701-055	164	701-130-100	165	705-004-WH-10	163	800-038	106	8PK-378C	NP-06
701-056	164	701-131	165	705-004-WH-20	163	800-039	112	8PK-SD010	111
701-057	164	701-131-100	165	705-004-WH-50	163	800-040	105	8PK-ST1520	NP-04
701-058	164	701-132	165	705-004-YL	163	800-041	111	8PK-ST850	NP-04
701-059	164	701-132-100	165	705-004-YL-10	163	800-042	111	900	
701-060	164	701-133	165	705-004-YL-20	163	800-043	106	900-002	125
701-061	164	701-135	165	705-004-YL-50	163	800-044	106	900-004	89
701-062	164	701-136	164	705-005-BK	163	800-045	106	900-008	89
701-063	164	701-137	165	705-005-BK-10	163	800-046	106	900-011	182
701-064	164	701-138	165	705-005-BK-20	163	800-047	106	900-012	125
701-065	164	701-138-100	165	705-005-BK-50	163	800-048	112	900-013	74
701-066	164	701-139	165	705-006-BK	163	800-048E	112	900-015	91
701-067	164	701-140	165	705-006-BK-10	163	800-049	104	900-016	92
701-068	164	701-142	164	705-006-BK-20	163	800-050	104	900-018N	88
701-069	164	701-143	165	705-006-BK-50	163	800-052	117	900-019	157
701-070	164	701-145	165	705-007-BU	163	800-060	102	900-020N	88
701-071	164	701-145-100	165	705-007-BU-10	163	800-066	117	900-022	125
701-072	164	701-146	164	705-007-BU-20	163	800-068	112	900-023	125
701-073	164	701-147	164	705-007-BU-50	163	800-070	158	900-026	78
701-074	164	701-148	164	705-008-BK	163	800-072	104	900-027	77
701-075	164	701-998	164	705-008-BK-10	163	800-073	102	900-032	156
701-076	164	702		705-008-BK-20	163	800-076	112	900-035	88
701-077	164	702-001	167	705-008-BK-50	163	800-077	104	900-036	88
701-078	164	702-008	167	744		800-078	112	900-037	91
701-079	164	702-009	167	744-FA03	167	800-079	104	900-038	118
701-080	164	702-013	167	744-FA50	167	800-080	111	900-039	177
701-081	164	702-018	167	76		800-081	113	900-040	177
701-082	164	702-021	167	764-RA03	167	800-091	117	900-041	177
701-083	165	702-022	167	764-RX50	167	800-092	105	900-043	177
701-084	165	702-059	167	78		800-092-50	105	900-045	182
701-085	165	702-063	167	788-FA03	167	800-093	107	900-048	181
701-086	165	702-066	167	788-FA50	167	800-094	107	900-049	160
701-087	165	702-067	167	788-FX15	167	800-095	107	900-052	183
701-088	165	702-079	167	788-FX50	167	800-096	107	900-054	183
701-088-100	165	703		788-RA03	167	800-097	107	900-055	105
701-089	165	703-001	167	788-RA50	167	800-098	107	900-056	125
701-090	165	703-002	167	788-RX15	167	800-099	107	900-057	125
701-091	165	703-003	167	788-RX50	167	800-100	107	900-058	94
701-097	165	703-004	167	800		800-101	107	900-061	133
701-097-100	165	703-005	167	800-001	106	800-102	107	900-061B	133
701-098	165	703-006	167	800-002	106	800-103	107	900-061-CLAMP	133
701-098-100	165	703-007	167	800-003	106	800-104	107	900-063	136
701-099	165	703-008	167	800-004	106	800-105	107	900-064	136
701-099-100	165	703-009	167	800-005	106	800-106	107	900-065	156
701-100	165	705		800-006	106	800-107	107	900-067	123
701-100-100	165	705-001-BK	163	800-007	104	800-108	107	900-068	123
701-101	165	705-001-BK-10	163	800-009	104	800-109	107	900-069	123
701-101-100	165	705-001-BK-20	163	800-010	106	800-110	107	900-070	123
701-102	165	705-001-BK-50	163	800-011	106	800-111	107	900-071	128
701-102-100	165	705-002-BU	163	800-012	106	800-112	107	900-072	128
701-103	165	705-002-BU-10	163	800-013	106	800-113	107	900-075	136
701-103-100	165	705-002-BU-20	163	800-014	106	800-114	97		

Cat.#	Page	Cat.#	Page	Cat.#	Page	Cat.#	Page	Cat.#	Page
900-075A	136	900-219	151	902-088	64	902-232	107	902-383-10	162
900-076	136	900-222	94	902-090	72	902-233	107	902-383-100	162
900-077	136	900-225	183	902-094	90	902-234	107	902-384-10	162
900-078	60	900-230	94	902-095	92	902-235	107	902-384-100	162
900-079	136	900-235	136	902-096	110	902-236	107	902-386	171
900-080	136	900-236	136	902-097	110	902-237	107	902-387	171
900-080B	136	900-238	94	902-099	109	902-238	137	902-388	171
900-081	136	900-239	139	902-100	117	902-239	137	902-389	171
900-082	136	900-242	92	902-101	118	902-240	135	902-390	115
900-091A	177	900-243	92	902-108	135	902-241	205	902-391	115
900-094	156	900-244	6	902-109	133	902-242	210	902-392	115
900-096	136	900-245	88	902-110	133	902-245	63	902-393	115
900-098-AST	171	900-246	185	902-112	177	902-246	43	902-394	156
900-098-BK	171	900-247	93	902-113	177	902-255	159	902-395	156
900-098-BU	171	900-248	93	902-114	177	902-256	159	902-396	156
900-098-GN	171	900-249	93	902-116	160	902-257	159	902-397	156
900-098-OR	171	900-250	92	902-117	160	902-258	46	902-398	156
900-098-RD	171	900-251	94	902-117-JAWS	160	902-259	46	902-402-10	166
900-098-WH	171	900-252	94	902-118	184	902-260	151	902-403-10	166
900-098-YL	171	900-253	94	902-119	184	902-267	7	902-404-10	166
900-099	92	900-255	158	902-121	189	902-268	76	902-405-10	166
900-100	92	900-257	49	902-137	55	902-269	76	902-406-10	166
900-103	158	900-257B	49	902-138	56	902-270	62	902-407-10	166
900-112	49	900-258	156	902-139	55	902-275	57	902-408-10	166
900-112B	49	900-260	184	902-140	NP-08	902-276	57	902-409-10	166
900-113	49	900-262	180	902-143	55	902-277	55	902-410-10	166
900-113B	49	900-263	129	902-145	56	902-278	55	902-411-10	166
900-114	125	900-264	129	902-146	55	902-279	55	902-412-10	166
900-115	90	900-265	129	902-147	55	902-305	171	902-413-10	166
900-116	125	900-266	129	902-148	56	902-306	NP-16	902-414-10	166
900-117	61,76	900-267	129	902-151	NP-08	902-307	43	902-415-10	166
900-118A	90	900-268	129	902-152	56	902-312	186	902-416-10	166
900-123	137	900-269	129	902-158	56	902-317	48	902-417-10	166
900-124	137	900-270	94	902-159	56	902-318	48	902-418-10	166
900-125	136	900-271	93	902-160	57	902-319	48	902-419-10	166
900-125B	136	900-272	93	902-161	56	902-321	173	902-420-10	166
900-126	136	902		902-162	57	902-323	78	902-421-10	166
900-132	125	902-011	29	902-166	56	902-324	78	902-422-10	166
900-133	125	902-012	171	902-168	57	902-325	78	902-423-10	166
900-135	49	902-013	171	902-169	56	902-326	78	902-424-10	166
900-137	151	902-014	171	902-171	55	902-329	88	902-425-10	166
900-138	149	902-015	171	902-172	55	902-330	56	902-426-10	166
900-140	80	902-016	171	902-186N	149	902-331	56	902-427-10	166
900-141	181	902-017	171	902-189	49	902-332	56	902-428-10	166
900-142	136	902-018	171	902-197	169	902-333	88	902-429-10	166
900-146	88	902-019	171	902-201	55	902-334	78	902-430-10	166
900-147	169	902-020	171	902-202	41	902-334-BLADES	78	902-431-10	166
900-147A	136	902-021	171	902-203	41	902-335	92	902-432-10	166
900-148	169	902-022	171	902-204	41	902-337	57	902-433-10	166
900-149	169	902-023	171	902-205	41	902-352	80	902-434-10	166
900-150	155	902-024	171	902-206	41	902-355	169	902-435-10	166
900-151	155	902-025	171	902-207	41	902-362	162	902-436-10	166
900-157	151	902-035	171	902-208	41	902-363	162	902-437-10	166
900-158	158	902-049	42	902-209	108	902-364	162	902-438-10	166
900-162A	176	902-054	55	902-210	108	902-365	162	902-439-10	166
900-162B	176	902-062	46	902-211	108	902-367-10	162	902-440-10	166
900-162C	176	902-068	139	902-212	108	902-367-100	162	902-441-10	166
900-164A	176	902-068B	139	902-213	108	902-368-10	162	902-442-10	166
900-164B	176	902-069	112	902-214	108	902-368-100	162	902-443-10	166
900-169	49	902-070	157	902-215	109,193	902-369	162	902-444-10	166
900-169B	49	902-071	129	902-216	108	902-370	162	902-445-10	166
900-176	151	902-072	128	902-217	108	902-371	162	902-446-10	166
900-177	158	902-073	157	902-218	109,193	902-372	115	902-447-10	166
900-179	160	902-075	29	902-219	103	902-373	115	902-448-10	166
900-181	94	902-076	29	902-220	108	902-374	115	902-449-10	166
900-194	112	902-077	29	902-221	135	902-375	115	902-450-10	166
900-199	182	902-078	37	902-222	102	902-376	115	902-451-10	166
900-203	182	902-079	37	902-224	156	902-377	115	902-452-10	166
900-204	128	902-082	50	902-226	117	902-378	115	902-453-10	166
900-205	157	902-083	50	902-227	90	902-379	115	902-454-10	166
900-206	91	902-084	50	902-228	10	902-380	115	902-455-10	166
900-215	48	902-085	53	902-229	76	902-381	115	902-456-10	166
900-216	157	902-086	60	902-230	49	902-382-10	162	902-457-10	166
900-217	123	902-087	62	902-231	107	902-382-100	162	902-458	85

Cat.#	Page	Cat.#	Page	Cat.#	Page	Cat.#	Page	Cat.#	Page
902-458-10	166	902-512	88	9SS-969-A1	84	CP-507	77	HX7/32X1-15/16	115
902-459	7	902-513	88	9SS-969-A2	84	CP-509	77	HX7/64X1	115
902-460	169	902-514	42	9SS-969-A3	84	CP-511A	75	HX7/64X1-15/16	115
902-461	154	902-515	42	9ST		CP-512	76	HX7X1	115
902-465	138	902-516	191	9ST-902	186	CP-521	76	HX9/32X1-15/16	115
902-466	138	902-518	55	B		CP-522	76	HX9/64X1	115
902-467	138	902-519	58	BHX1/4X3-1/2	115	CP-5S1D	57,58	HX9/64X1-15/16	115
902-468	138	902-520	58	BHX1/8X3-1/2	115	CP-5S2D	57,58	MA	
902-469	138	902-529	94	BHX2.5X3-1/2	115	D		MA-016	136
902-470	170	902-532	155	BHX2X3-1/2	115	DK-2053A	170	MA-019	137
902-471	170	902-533	155	BHX3/16X3-1/2	115	DK-2112	48	MA-020	137
902-472	170	902-534	88	BHX3/32X3-1/2	115	DP-366D	89	MA-021	137
902-475	170	905-535	88	BHX3X3-1/2	115	DP-366J	89	MA-022	137
902-476	170	902-536	55	BHX4X3-1/2	115	DP-366P	89	MA-023	137
902-477	170	902-537	55	BHX5/32X3-1/2	115	F		MA-1004A	134
902-478	170	902-538	55	BHX5/64X3-1/2	115	FB-1688C	150	MA-1006A	134
902-480	69	902-540	NP-09	BHX5X3-1/2	115	FB-6008-0.5D	151	MA-1008A	132
902-480-DIE-300MCM	69	902-541	NP-10	BHX6X3-1/2	115	FB-6008-15SIC	151	MA-1013MA	135
902-480-DIE-350MCM	69	902-542	NP-10	BHX7/32X3-1/2	115	FB-6008-1D	151	MA-1205CA-B	133
902-480-DIE-500MCM	69	902-543	NP-14	BHX7/64X3-1/2	115	FB-6008-30D	151	MA-1209LA	132
902-480-DIE-600MCM	69	902-544	NP-09	BHX9/64X3-1/2	115	FB-6008-30SIC	151	MA-1219A	132
902-480-DIE-800MCM	69	902-545	NP-15	BITASST1	115	FB-6008-3D	151	MA-1503A	133
902-480-DIE1-0	69	902-546	NP-15	BITASST2	115	FB-6008-6D	151	MA-1601A	134
902-480-DIE-AWG2	69	902-547	NP-08	Bulb-T4	135	FB-6008-9D	151	MS	
902-480-DIE2-0	69	902-548	NP-08	Bulb-T5	133	FB-C008	150	MS-018	94
902-480-DIE3-0	69	902-549	NP-08	C		FB-C009	150	MS-153C	94
902-480-DIE-AWG4	69	902-549-100	NP-08	CAT6-100	167	FB-C010	150	MS-161	157
902-480-DIE4-0	69	902-549-50	NP-08	CE-0275	156	FL-516	139	MS-3176	100
902-480-DIE-AWG6	69	902-550	NP-08	CP-148	61	FL-603	139	MS-3207	78
902-481	144	902-550-100	NP-08	CP-151B	67	G		MS-3209	104
902-481-SBM	144	902-550-50	NP-08	CP-246	74	GK-368	90	MS-322	158
902-481-SBS	144	902-551	NP-08	CP-251B	67	GK-67330-8	90	MS-5156	NP-07
902-482	144	902-551-10	NP-08	CP-3005F	53	GS-210	89	MS-525	154
902-483	145	902-551-50	NP-08	CP-3006F	58	GS-23K	89	MS-526	154
902-484	69	902-554	NP-16	CP-3006FD2	58	H		MS-710	139
902-484-DIE-300MCM	69	902-555	NP-16	CP-3006FD36	58	HW-229B	118	MS-C002	159
902-484-DIE-350MCM	69	902-556	NP-16	CP-3006FS1	58	HW-312B	123	MS-I52	NP-07
902-484-DIE-500MCM	69	902-557	NP-16	CP-3006FS2	58	HW-312S	123	MS-I5S2	NP-07
902-484-DIE-600MCM	69	902-558	NP-02	CP-301G	72	HW-6509B	123	MS-I62	NP-07
902-484-DIE1-0	69	9CP		CP-302G	72	HW-6514B	123	MS-I6S2	NP-07
902-484-DIE-AWG2	69	9CP-336DF4	56	CP-313	63	HW-928	117	MS-I6SP2	NP-07
902-484-DIE2-0	69	9DK		CP-3145A	80	HW-T21-40200	120	MT	
902-484-DIE3-0	69	9DK-2053A-B	170	CP-3147	81	HW-T21-60340	120	MT-1132	17
902-484-DIE-AWG4	69	9PK		CP-3148	81	HW-T41-315	120	MT-1210	17
902-484-DIE4-0	69	9PK-3003D26	57	CP-315	63	HW-T41-525	120	MT-1217	15
902-484-DIE-AWG6	69	9PK-3003D27	56	CP-3150	81	HW-T716-3	120	MT-1232	16
902-485	144	9PK-3003D29	55	CP-316	63	HW-T83-20100	120	MT-1233C	18
902-486	144	9PK-3003D36	56,58	CP-321	NP-07	HW-V608	NP-11	MT-1233D	18
902-487	144	9PK-3003D42	56	CP-333	60	HW-V610	NP-11	MT-1270	16
902-488	144	9PT		CP-336FD27	56	HW-V612	NP-11	MT-1280	16
902-489	144	9PT-5201A-P	143	CP-351B	67	HW-V708	NP-11	MT-1506	NP-01
902-490	144	9PT-5201-P2	143	CP-353	67	HW-V710	NP-11	MT-1508	17
902-491	75	9SS		CP-367A	74	HX1.5X1	115	MT-1630	18
902-491-BLADE	75	9SS-257-HT	86	CP-372FD27	56	HX1/16X1	115	MT-1705	14
902-492	141	9SS-257-SI	86	CP-376K	59	HX1/16X1-15/16	115	MT-1707	NP-01
902-493	141	9SS-900-A1	83	CP-376M	60	HX1/4X1	115	MT-1710	14
902-494	141	9SS-900-A2	83	CP-382	173	HX1/4X1-15/16	115	MT-1860	14
902-495	142	9SS-900-A3	83	CP-383	173	HX1/8X1	115	MT-2017	20
902-496	142	9SS-900-B	83	CP-385	173	HX1/8X1-15/16	115	MT-2018	20
902-497	177	9SS-900-C	83	CP-386	66	HX2.5X1	115	MT-3102	19
902-498	66	9SS-900-D	83	CP-391	172	HX2X1	115	MT-3109	19
902-499	65	9SS-900-E	83	CP-391-1	172	HX3/16X1	115	MT-3112	NP-01
902-500	145	9SS-900-F	83	CP-391-2	172	HX3/16X1-15/16	115	MT-3266	19
902-501	145	9SS-900-H	83	CP-392	172	HX3/32X1	115	MT-4606	NP-03
902-502	145	9SS-900-I	83	CP-392-3	172	HX3/32X1-15/16	115	MT-4611	23
902-503	145	9SS-900-J	83	CP-392-4	172	HX3X1	115	MT-4612	23
902-504	145	9SS-900-K	83	CP-392-5	172	HX4X1	115	MT-4615	23
902-505	145	9SS-900-L	83	CP-412G	66	HX5/32X1	115	MT-4616	22
902-506	145	9SS-900-M	83	CP-413G	66	HX5/32X1-15/16	115	MT-4617	22
902-507	145	9SS-900-N	83	CP-415	66	HX5/64X1	115	MT-4617LED	NP-03
902-508	145	9SS-900-O	83	CP-416	64	HX5/64X1-15/16	115	MT-4618	22
902-509	145	9SS-900N-SI	83	CP-418	62	HX5X1	115	MT-5110	15
902-510	145	9SS-900NE-HG	83	CP-462G	65	HX6X1	115	MT-5211	15
902-511	159	9SS-900N-HT	83	CP-463	65	HX7/32X1	115	MT-7028	9

Cat.#	Page	Cat.#	Page	Cat.#	Page	Cat.#	Page	Cat.#	Page
MT-7057N	11	PM-252	30	SD-081-M3	98	SD-7222B	110	SSP8X1	114
MT-7058	11	PM-254	30	SD-081-M3.5	98	SD-800-111	108	ST-3216	185
MT-7063	NP-02	PM-396F	31	SD-081-M4	98	SD-800-18	108	ST-5203	186
MT-7071	8	PM-396G	31	SD-081-M4.5	98	SD-800-19	108	ST-5208	186
MT-7071U	8	PM-396H	31	SD-081-M5	98	SD-800-S3.0	108	ST-5504	186
MT-7501	149	PM-396I	31	SD-081-M5.5	98	SD-800-S5.5	108	ST-5601	186
MT-7505	149	PM-396J	31	SD-081-M6	98	SD-804	105	SW-2125H	106
MT-7509	149	PM-396K	31	SD-081-P1	98	SD-804-1	105	T	
MT-7601	148	PM-721	37	SD-081-P2	98	SD-9313	99	T10HX1	114
MT-7602	148	PM-723	37	SD-081-P3	98	SD-9314	100	T10HX1-15/16	114
MT-7610A	NP-05	PM-727	37	SD-081-P4	98	SD-9315	101	T10X1	114
MT-8006B	7	PM-728	37	SD-081-P5	98	SD-9316	101	T10X1-15/16	114
MT-8006VA	7	PM-731	34	SD-081-P6	98	SD-9326M	100	T15HX1	114
MT-8100	5	PM-736	34	SD-081-P7	98	SD-9608	102	T15HX1-15/16	114
MT-9906	25	PM-737	34	SD-081-S1	98	SD-9802	101	T15X1	114
MT-9907	25	PM-746	34	SD-081-S2	98	SD-9804	101	T15X1-15/16	114
MTB-1	185	PM-754	34	SD-081-S3	98	SD-9810A-BC	105	T20HX1	114
NT		PM-755	34	SD-081-S4	98	SD-9811	103	T20HX1-15/16	114
NT-306	24	PM-760	36	SD-081-S5	98	SD-9812	103	T20X1	114
NT-309	NP-04	PM-761	36	SD-081-S6	98	SD-9814	103	T20X1-15/16	114
NT-311	24	PM-763	36	SD-081-S7	98	SD-9815	103	T25HX1	114
NT-312	24	PM-764	36	SD-081-S8	98	SD-9817	111	T25X1	114
NT-6352	24	PM-765	36	SD-081-T1	98	SD-9819	103	T25X1-15/16	114
NT-8540	21	PM-771	36	SD-081-T10	98	SD-9824	100	T27HX1	114
NT-8560	21	PM-773	36	SD-081-T10H	98	SD-9828	99	T27HX1-15/16	114
NT-8580	21	PM-774	36	SD-081-T15	98	SD-T635-0112	121	T27X1	114
PD		PM-808	34	SD-081-T15H	98	SD-T635-16	121	T27X1-15/16	114
PD-155	155	PM-924	43	SD-081-T2	98	SD-T635-510	121	T30HX1	114
PD-160	155	PN		SD-081-T20	98	SD-T636	122	T30HX1-15/16	114
PD-372	160	PN-378D	NP-06	SD-081-T20H	98	SD-T860	122	T30X1	114
PD-395A	49	PN-378E	NP-06	SD-081-T3	98	SI-125A-15	88	T30X1-15/16	114
PD-998	48	PN-378F	NP-06	SD-081-T4	98	SI-125A-20	88	T5X1	114
PD-V004A	NP-11	PN-378G	NP-06	SD-081-T5	98	SI-132A	NP-13	T5X1-15/16	114
PH		PT		SD-081-T5H	98	SI-B162	NP-13	T6X1	114
PH0X1	114	PT-1136A	142	SD-081-T6	98	SK-22401M	195	T6X1-15/16	114
PH0X1-15/16	114	PT-1362U	NP-14	SD-081-T6H	98	SK-42601M	195	T7HX1	114
PH1X1	114	PT-5201A	143	SD-081-T7	98	SK-V831	NP-11	T7HX1-15/16	114
PH1X1-15/16	114	PT-5202A	143	SD-081-T7H	98	SK-V832	NP-11	T7X1	114
PH2X1	114	PT-5203A	143	SD-081-T8	98	SK-V851	NP-11	T7X1-15/16	114
PH2X1-15/16	114	PT-5501A	143	SD-081-T8H	98	SK-V852	NP-11	T8HX1	114
PH3X1	114	PZ		SD-081-T9	98	SL1012X1-15/16	114	T8HX1-15/16	114
PH3X1-15/16	114	PZ0X1-15/16	114	SD-081-T9H	98	SL1214X1-15/16	114	T8X1	114
PK		PZ1X1-15/16	114	SD-081-TA20	98	SL12X1-15/16	114	T8X1-15/16	114
PK-12012H	206	PZ2X1-15/16	114	SD-081-TA23	98	SL23X1-15/16	114	T9HX1	114
PK-14019A	209	PZ3X1-15/16	114	SD-081-TA27	98	SL34X1-15/16	114	T9HX1-15/16	114
PK-15307EI	197	PZ4X1-15/16	114	SD-081-TRI0	98	SL45X1-15/16	114	T9X1	114
PK-15308EM	202	S		SD-081-TRI00	98	SL56X1-15/16	114	T9X1-15/16	114
PK-2006	203	S1X1	114	SD-081-TRI000	98	SL68X1-15/16	114	TC-131	180
PK-2061	59	S1X1-15/16	114	SD-081-TRI1	98	SL810X1-15/16	114	TC-265	179
PK-2061	196	S2X1	114	SD-081-TS1	98	SN-390	91	TC-266	179
PK-2809M	193	S2X1-15/16	114	SD-081-Z1	98	SN-396	91	TC-267	179
PK-2811M	192	S3X1	114	SD-081-Z2	98	SR-008	45	TC-765	181
PK-2812M	192	S3X1-15/16	114	SD-081-Z3	98	SR-228	44	TE-8202A-W	NP-05
PK-2813M	192	S4X1	114	SD-081-Z4	98	SR-333	50	TS10HX1	114
PK-2836M	194	S4X1-15/16	114	SD-0839	97	SR-363A	72	TS15HX1	114
PK-4023EI	211	SB-2419	177	SD-083-P2	97	SR-363B	72	TS20HX1	114
PK-4302AI	207	SB-2918	175	SD-083-P3	97	SR-538	46	TZ-202N	127
PK-5011	203	SB-3218	175	SD-083-P4	97	SR-V210	NP-11	TZ-204N	127
PK-6940	152	SB-3428SB	176	SD-083-S3	97	SR-V336	NP-11	TZ-205N	127
PK-6942	152	SB-4121	175	SD-083-S4	97	SR-V537	NP-11	TZ-212N	127
PK-9110	100	SB-4536B	176	SD-083-S5	97	SS-206EU	87	TZ-225N	127
PK-9112	189	SD-081A	98	SD-083-T4	97	SS-207EU	87		
PK-9458	152	SD-081-A1	98	SD-083-T5H	97	SS-256EU	NP-12		
PK-ST902	38	SD-081-A2	98	SD-083-T6H	97	SS-257EU	86		
PM		SD-081E	99	SD-2310	113	SS-259EU	NP-12		
PM-023CN	38	SD-081G	98	SD-2313	111	SS-331E	84		
PM-029CN	38	SD-081-H1	98	SD-2318M	113	SS-611A	85		
PM-036CN	38	SD-081-H2	98	SD-2319M	113	SS-969E	84		
PM-037CN	38	SD-081-H3	98	SD-2404	110	SS-989E	83		
PM-046CN	38	SD-081-H4	98	SD-3502	104	SSP10X1	114		
PM-053CN	38	SD-081-H5	98	SD-7213A	110	SSP12X1	114		
PM-055CN	38	SD-081-H6	98	SD-7213B	110	SSP4X1	114		
PM-251	30	SD-081-H7	98	SD-7222A	110	SSP6X1	114		



Merchandising Support

ECLIPSESM
YOUR COMPLETE TOOL & ACCESSORY SOURCE



Promote our products...

...Increase your sales

We offer a variety of merchandising options to help our distributors promote our products. Please check with your sales representative for current offers.

Me



eclipseSM

Eclipse Enterprises, Inc.

13302 Chula Road, Amelia Court House, VA 23002

Phone: 804-561-2610 Fax: 804-561-2642

<http://www.eclipsetools.com>

